

NMT DOC.450-3

Nordic Mobile Telephone group

Automatic Cellular Mobile Telephone System

NORDIC NMT-450



TECHNICAL SPECIFICATION FOR THE MOBILE STATION

© The copyright to the specifications herein is property of Tele Danmark Mobil, Denmark, Telenor Mobil, Norway, Telia Mobitel, Sweden, Telecom Finland, Finland. The specifications may be used and/or copied only with written permission.



NMT-450

NMT DOC 450-3

Mobile station

List of changes in NMT Doc 450-3
Reference is made to NMT Doc 450-3 1994-06-01

First sequence below is defined as:

Contents, Chapter, Annex, page and paragraph, line

Ch 2.4.1.2.2, pa 1	Change text as in Doc 900-3 94-06-30: Test signal of 10 dB (μ V) E.M.F. and 90 dB (μ V) E.M.F. at the nominal frequency of the receiver shall be applied successively to the antenna terminal. The test signal shall be modulated successively with 3945, 4000 and 4055 Hz tones to frequency deviation of ± 300 Hz.
Ch 2.4.1.3, pa 2	Change text as in Doc 900-3 94-06-30, except limit $\pm 10\%$: The transmitted supervisory signal (\emptyset -signal) shall not exceed ± 300 Hz $\pm 10\%$ deviation under all test conditions.
A2, Ch C2.1, pa3, pr 2	Add (specified in standard ETS 300086)anechoic room (spe....
A3, Ch C2	Text as in Annex 2 Ch C2 Receiver duplex sensitivity degradation
A5, Ch 1, pa 1, pr 2, ln 2	change Administration to type approval authorities
A5, Ch 4, pa 2, pr 1, ln 3	change Administration to operator
A5, Ch 4, pa 2, pr 2, ln 1	change Administration to operator
A5, Ch 4, pa 2, pr 3, ln 1	change Administration to operator
A5, Ch 5, pa 2, pr 1	change Administration to type approval authorities
A5, Ch 6, pa 2, pr 1	change Administration to type approval authorities
A7, Ch 2.8, pa 6, pr 1, ln 3	change type approval authorities/accredited testlaboratory to type approval authorities
A7, Ch 2.10, pa 6, pr 1	change type approval authorities/accredited testlaboratory to type approval authorities
A18, Ch 3.4.3, pa 4	text as in Ch 3.3.8: The EE may be equipped with automatic call set up and answering facilities.
A18, Ch 3.7.1.1, pa 4	remove v.5 ... MSg 93-594 v.5
A18, Encl. 1, pa 5	remove v.5 ... MSg 93-594 v.5

A19, Ch 1, pa 1, pr 3	Change Telecommunications Administrations to type approval authorities
Ch 1.3.3.2, pa 2, pr 2	Delete paragraph For tests as specified.....
A3, Ch 1.3.3.2	Delete chapter 1.3.3.2
Annex 2 and 3	<p data-bbox="587 450 874 488">Added chapter 5.7.1.3</p> <p data-bbox="587 488 1477 562">5.7.1.3 Additional autonomous power control in MS (optional)</p> <p data-bbox="587 562 1477 763">If the received power bits from MTX are 10 (medium power) and if the mean RF level received in MS during conversation is above 30 dB (μV) E.M.F. \pm5 dB (but below 55 dB (μV) E.M.F.) for 5 seconds, the RF output power shall be reduced to 500 mW \pm 2 dB. In the signalling towards MTX, however, the received power bits from MTX shall be used.</p> <p data-bbox="587 763 1477 898">When the received mean RF level during conversation decreases to below 20 dB (μV) E.M.F. \pm5 dB for 5 seconds, the RF output level shall be increased to the maximum RF output power indicated by the MTX signalling. The hysteresis shall be at least 8 dB.</p>
Ch 3.8 pa 8	<p data-bbox="587 1021 914 1059">Add paragraph after table:</p> <p data-bbox="587 1070 1409 1155">Y1=0000 is recommended for systems with no roaming with the existing 450 countries.</p>
3.8,pa3	added.new line.. A mobile station without country selector can not roam to another country.
3.8, table	Y1 values edited
2.2.15.2, pa6	deleted "1.3.3.2 and"
2.2.15.3, pa1 and pa2	deleted "1.3.3.2 and"
2.3.19.2, pa2	deleted "1.3.3.2 and"
2.3.19.3, pa1 and pa2	deleted "1.3.3.2 and"

A full documentation of

NMT Doc 450-3
Technical Specification for the Mobile Station

consists of:

A NMT Doc 450-3, 1995-10-04

B MS LETTERS TO MANUFACTURERS

-	MS 88-26	15.07.1988	NMT Doc 88-2022	SIS specification
-	MS 88-27	29.09.1988	NMT Doc 88-2060	SIS specification
-	MS 88-29	30.11.1988	NMT Doc 88-2084	SIS specification
-	MS 89-31	29.05.1989	NMT Doc 89-2163	SIS specification
-	MS 89-32	06.10.1989	NMT Doc 89-2216	SIS specification

CONTENTS

1.	GENERAL		
1.1	INTRODUCTION	Rev 95-10-04	Ch 1.1 (3)
1.1.1	System concepts		
1.1.2	Radio frequencies		
1.1.2.1	Extended band (optional , subject to national regulations)		
1.1.3	Call set-up procedures		
1.1.3.1	Call to mobile station		
1.1.3.2	Call from mobile station		
1.1.4	Switching call in progress		
<hr/>			
1.2	MOBILE STATION UNITS	Rev 95-10-04	Ch. 1.2 (3)
1.2.1	Transceiver Unit		
1.2.2	Operational Controls Unit		
1.2.3	Logic and Control Unit		
1.2.4	Signalling equipment		
<hr/>			
1.3	GENERAL CONDITIONS	Rev 95-10-04	Ch. 1.3 (10)
1.3.1	General requirements		
1.3.1.1	Marking of the equipment		
1.3.1.2	Warming up period		
1.3.2	Terminals		
1.3.2.1	Test terminals		
1.3.2.2	Antenna terminal		
1.3.2.3	Voice input and output terminals		
1.3.2.4	Arrangement for testing		
1.3.2.5	External equipment		
1.3.3	Test of the equipment		
1.3.3.1	Application of the test conditions		
1.3.3.2	Power supply		
1.3.4	Normal test conditions		
1.3.4.1	Normal temperature and humidity		
1.3.4.2	Normal test power source		
1.3.5	Extreme test conditions		
1.3.5.1	Temperatures at testing under extreme conditions		
1.3.5.2	Power supply voltages at testing under extreme conditions		
1.3.5.3	Procedure for tests at extreme temperatures		
1.3.5.4	Storage conditions		
1.3.6	Arrangement for test signals applied to the antenna terminal for receiver testing purposes		
1.3.7	Artificial antenna (dummy load)		

- 1.3.8 Test modulations
 - 1.3.8.1 Normal test modulation
 - 1.3.8.2 Data test modulation
 - 1.3.8.3 Supervisory signal modulation
- 1.3.9 Definitions of some measuring instruments
 - 1.3.9.1 Adjacent channel power measuring receiver
 - 1.3.9.2 Psophometric filter
 - 1.3.9.3 SINAD meter
- 1.3.10 Vibration test
 - 1.3.10.1 Vibration (Sweep)
 - 1.3.10.2 Vibration (Random), alternative test
- 1.3.11 Test site and general arrangements for measurements involving the use of radiated fields
 - 1.3.11.1 Test site
 - 1.3.11.2 Test antenna
 - 1.3.11.3 Substitution antenna
 - 1.3.11.4 Alternative indoor site
- 1.3.12 Receiver rated audio output power

2. TRANSCEIVER UNIT

- | | | | |
|-----|---------|--------------|-------------|
| 2.1 | GENERAL | Rev 95-10-04 | Ch. 2.1 (1) |
|-----|---------|--------------|-------------|
-
- | | | | |
|-----|-------------|--------------|--------------|
| 2.2 | TRANSMITTER | Rev 95-10-04 | Ch. 2.2 (12) |
|-----|-------------|--------------|--------------|
- 2.2.1 Frequency range and channel separation
 - 2.2.1.1 Extension band (optional , subject to national regulations)
 - 2.2.2 Number of channels
 - 2.2.2.1 Extension band (optional, subject to national regulations)
 - 2.2.3 Frequency error
 - 2.2.3.1 Definition
 - 2.2.3.2 Method of measurement
 - 2.2.3.3 Requirement
 - 2.2.4 Transmitter carrier power
 - 2.2.4.1 Definition
 - 2.2.4.2 Method of measurement
 - 2.2.4.3 Requirements
 - 2.2.4.4 Load test
 - 2.2.5 Transmitter carrier power control
 - 2.2.6 Carrier on/off condition and carrier rise/decay time
 - 2.2.7 Transmitter channel switching time
 - 2.2.8 Spurious emissions
 - 2.2.8.1 Definition
 - 2.2.8.2 Method of measuring the conducted power level
 - 2.2.8.3 Method of measuring the effective radiated power
 - 2.2.8.4 Requirements

2.2.9	Frequency deviation
2.2.9.1	Maximum permissible frequency deviation without supervisory signal
2.2.9.1.1	Definition
2.2.9.1.2	Method of measurement
2.2.9.1.3	Requirements
2.2.10	Limiting characteristics of modulator
2.2.10.1	Definition
2.2.10.2	Method of measurement
2.2.10.3	Requirements
2.2.11	Adjacent channel power
2.2.11.1	Definition
2.2.11.2	Method of measurement
2.2.11.3	Requirements
2.2.12	Audio-frequency response of the transmitter
2.2.12.1	Definition
2.2.12.2	Method of measurement
2.2.12.3	Requirements
2.2.13	Harmonic distortion factor in transmission
2.2.13.1	Definition
2.2.13.2	Method of measurement
2.2.13.3	Requirements
2.2.14	Relative audio-frequency intermodulation product level of the transmitter
2.2.14.1	Definition
2.2.14.2	Method of measurement
2.2.14.3	Requirements
2.2.15	Residual modulation
2.2.15.1	Definition
2.2.15.2	Method of measurement
2.2.15.3	Requirements
2.2.16	Transmitter audio muting
2.2.16.1	Definition
2.2.16.2	Method of measurement
2.2.16.3	Requirements

2.3	RECEIVER	Rev 95-10-04	Ch. 2.3 (13)
2.3.1	Frequency range and channel separation		
2.3.1.1	Extension band (optional, subject to national regulations)		
2.3.2	Number of channels		
2.3.2.1	Extension band (optional, subject to national regulations)		
2.3.3	Duplex separation		
2.3.4	Receiver detection and switching time		
2.3.5	Reduced channel locking capability		
2.3.6	RF carrier detector		
2.3.7.1	RF-sensitivity		
2.3.7.1.1	Definition		
2.3.7.1.2	Method of measurement		
2.3.7.1.3	Requirements		

2.3.7.2	Receiver duplex sensitivity degradation
2.3.7.2.1	Definition
2.3.7.2.2	Method of measurement
2.3.7.2.3	Requirements
2.3.8	Co-channel rejection
2.3.8.1	Definition
2.3.8.2	Method of measurement
2.3.8.3	Requirements
2.3.9	Adjacent channel selectivity
2.3.9.1	Definition
2.3.9.2	Method of measurement
2.3.9.3	Requirements
2.3.11	Spurious response rejection
2.3.11.1	Definition
2.3.11.2	Method of measurement
2.3.11.3	Requirements
2.3.12	Intermodulation rejection
2.3.12.1	Definition
2.3.12.2	Method of measurement
2.3.12.3	Requirements
2.3.13	Blocking
2.3.13.1	Definition
2.3.13.2	Method of measurement
2.3.13.3	Requirements
2.3.14	Spurious emissions
2.3.14.1	Definition
2.3.14.2	Method of measuring the conducted power
2.3.14.3	Method of measuring the effective radiated power
2.3.14.4	Requirements
2.3.15	Harmonic distortion ratio
2.3.15.1	Definition
2.3.15.2	Method of measurement
2.3.15.3	Requirements
2.3.16	Relative audio frequency intermodulation product level
2.3.16.1	Definition
2.3.16.2	Method of measurement
2.3.16.3	Requirements
2.3.17	Amplitude characteristics of the receiver limiter
2.3.17.1	Definition
2.3.17.2	Method of measurement
2.3.17.3	Requirements
2.3.18	AM-suppression
2.3.18.1	Definition
2.3.18.2	Method of measurement
2.3.18.3	Requirements

2.3.19	Noise and hum
2.3.19.1	Definition
2.3.19.2	Method of measurement
2.3.19.3	Requirements
2.3.20	Audio frequency response
2.3.20.1	Definition
2.3.20.2	Method of measurement
2.3.20.3	Requirements
2.3.21	Receiver audio muting
2.3.21.1	Definition
2.3.21.2	Method of measurement
2.3.21.3	Requirements

2.4	Ø-SIGNAL LOOP AND TRANSCEIVER COUPLING	
	Rev 95-10-04	Ch. 2.4 (7)

2.4.1	Supervisory signal deviation
2.4.1.1	Definition
2.4.1.2	Method of measurement
2.4.1.2.1	Calibration set up
2.4.1.2.2	Measurement set up
2.4.1.3	Requirements
2.4.2	Transceiver coupling
2.4.2.1	RX-TX
2.4.2.1.1	Definition
2.4.2.1.2	Method of measurement
2.4.2.1.3	Requirements
2.4.2.2	TX-RX
2.4.2.2.1	Definition
2.4.2.2.2	Method of measurement
2.4.2.2.3	Requirements
2.4.3	Interference in the Ø-signal frequency band
2.4.3.1	Definition
2.4.3.2	Method of measurement
2.4.3.3	Requirements
2.4.4	Relative audio frequency intermodulation product level in the Ø-signal loop
2.4.4.1	Definition
2.4.4.2	Method of measurement
2.4.4.3	Requirements

2.5	VOICE PROCESSING REQUIREMENTS, TRANSMITTING	
	Rev 95-10-04	Ch. 2.5 (8)

2.5.1	Compression linearity
2.5.1.1	Definition
2.5.1.2	Method of measurement
2.5.1.3	Requirements

2.5.2	Transient response of the compressor
2.5.2.1	Definition
2.5.2.2	Method of measurement
2.5.2.3	Requirements
2.5.3	Attack time and recovery time of the compressor
2.5.3.1	Definition
2.5.3.2	Method of measurement
2.5.3.3	Requirements
2.5.4	Send frequency response
2.5.4.1	Definition
2.5.4.2	Method of measurement
2.5.4.3	Requirements
2.5.5	Send loudness rating
2.5.5.1	Definition
2.5.5.2	Calculation method
2.5.5.3	Requirements
2.5.6	Transmit distortion
2.5.6.1	Definition
2.5.6.2	Method of measurement
2.5.6.3	Requirements
2.5.7	Transmission idle noise
2.5.7.1	Definition
2.5.7.2	Method of measurement
2.5.7.3	Requirements
2.5.8	Noise cancelling device
2.5.8.1	Definition
2.5.8.2	Method of measurement
2.5.8.3	Requirements
2.5.9	Separate microphone

2.6	VOICE PROCESSING REQUIREMENTS, RECEIVING
	Rev 95-10-04

Ch. 2.6 (7)

2.6.1	Expansion linearity
2.6.1.1	Definition
2.6.1.2	Method of measurement
2.6.1.3	Requirements
2.6.2	Transient response of the expander
2.6.2.1	Definition
2.6.2.2	Method of measurement
2.6.2.3	Requirements
2.6.3	Receive frequency response
2.6.3.1	Definition
2.6.3.2	Method of measurement
2.6.3.3	Requirements
2.6.4	Receive loudness rating
2.6.4.1	Definition
2.6.4.2	Calculation method
2.6.4.3	Requirements

- 2.6.5 Receive volume control
- 2.6.6 Receive harmonic distortion
 - 2.6.6.1 Definition
 - 2.6.6.2 Method of measurement
 - 2.6.6.3 Requirements
- 2.6.7 Receive idle noise
 - 2.6.7.1 Definition
 - 2.6.7.2 Method of measurement
 - 2.6.7.3 Requirements
- 2.6.8 Maximum sound level of handset earpiece
- 2.6.9 Volume control in "Hands-Free" mode

2.7	STABILITY LOSS	Rev 95-10-04	Ch. 2.7 (1)
------------	-----------------------	--------------	-------------

3	OPERATIONAL CONTROLS UNIT (OCU)	Rev 95-10-04	Ch. 3 (11)
----------	--	--------------	------------

- 3.1 **MOBILE TELEPHONE IDENTIFICATION NUMBER**
 - 3.1.1 Secret authentication key
 - 3.1.1.1 The generation and programming of SAKs
 - 3.1.1.1.1 General requirements
 - 3.1.1.1.2 Generation of the SAK
- 3.2 "ON/OFF" SWITCH (OPTION)
- 3.3 HANDSET (OPTION)
- 3.4 "HANDS-FREE" OPERATION — "HANDS-FREE" BUTTON (OPTION)
- 3.5 DELETED
- 3.6 DIALLING FACILITIES (OPTION)
 - 3.6.1 Push-button set
 - 3.6.2 Dialed digits memory (DDM)
- 3.7 ACOUSTIC SIGNALS GENERATED BY THE MOBILE STATION (OPTION)
 - 3.7.1 General
 - 3.7.2 Ringing signal
 - 3.7.3 Malfunction alarm
- 3.8 COUNTRY SELECTOR (OPTION)
- 3.9 VISUAL INDICATORS
 - 3.9.2 Service indicator
 - 3.9.3 Call received indicator (OPTION)
 - 3.9.4 Roaming alarm indicator
 - 3.9.5 Dialed digits display (OPTION)
 - 3.9.6 Electrical off hook indicator
 - 3.9.7 Selected country indicator (OPTION)
- 3.10 SUPPLEMENTARY FACILITIES (OPTION)
 - 3.10.1 Shift mode

- 3.10.2 Immediate call transfer indication
- 3.10.3 Transmission of MFT signalling from MS
- 3.10.4 Locking facility

4 OPERATIONAL PROCEDURES

Rev 95-10-04

Ch. 4 (7)

- 4.1 GENERAL REQUIREMENTS (OPTION)
- 4.2 MANUAL ROAMING UPDATING
 - 4.2.1 Updating by initiating "off-hook"
 - 4.2.2 Updating by generating a call
- 4.3 ABBREVIATED DIALLING (OPTION)
- 4.4 DIALLED DIGITS MEMORY (DDM) (OPTION)
- 4.5 ADDITIONAL USE OF THE PUSH-BUTTON SET (OPTION)

5 LOGIC AND CONTROL UNIT (LCU) AND SIGNALLING EQUIPMENT

- 5.1 GENERAL Rev 95-10-04 Ch. 5.1 (2)
-
- 5.2 DESCRIPTION OF LCU ACTIVITIES Rev 95-10-04 Ch. 5.2 (18)
 - 5.2.1 Description of main states
 - 5.2.1.1 Power off
 - 5.2.1.2 Standby
 - 5.2.1.3 Conversation
 - 5.2.1.4 Search for channels
 - 5.2.1.4.1 Definitions
 - 5.2.1.4.2 Channel acceptance procedure
 - 5.2.1.5 Search for calling channel
 - 5.2.1.6 Search for free marked traffic channel (MS electrically off hook)
 - 5.2.1.7 Search for TC, roaming flag set, MS on hook
 - 5.2.1.8 Search for TC, no roaming flag set, MS on hook.
 - 5.2.1.9 Signalling schemes, (see fig 5.2. and paragraph 5.4)
 - 5.2.1.10 User initiated "on-hook" in the signalling schemes
 - 5.2.1.11 User initiated "off-hook" in the signalling schemes
 - 5.2.1.12 Authentication procedure and encryption of B-subscriber number
 - 5.2.2 Minor states within the signalling schemes
 - 5.2.3 Task description
 - 5.2.3.1 Power on task
 - 5.2.3.2 Power off task
 - 5.2.3.3 Selection of random channel
 - 5.2.3.4 Timing supervision.

5.3	INPUT/OUTPUT STATE RELATIONS	Rev 95-10-04	Ch. 5.3 (20)
5.3.1	Structure of the state table		
<hr/>			
5.4	FLOW DIAGRAMS	Rev 95-10-04	Ch. 5.4 (16)
5.4.1	Main states for LCU		
5.4.2	Call MS - MTX (signalling scheme A)		
5.4.3	Call MTX to MS (signalling scheme B)		
5.4.4	Call MTX-MS (signalling scheme B1)		
5.4.5	Switching call in progress (SCIP) (signalling scheme C) or MS power change.		
5.4.6	Updating roaming information (signalling scheme D)		
5.4.7	MS clearing		
5.4.8	Forced release from MTX		
5.4.9	Authentication during conversation		
<hr/>			
5.5	SIGNALLING EQUIPMENT FOR 1200 BAUD FFSK	Rev 95-10-04	Ch. 5.5 (2)
5.5.1	General description		
5.5.2	FFSK modulation in MS		
5.5.3	FFSK signal receiver		
5.5.4	Splitting in MS		
5.5.5	FFSK signalling detection time		
<hr/>			
5.6	TIMING IN THE MS	Rev 95-10-04	Ch. 5.6 (3)
5.6.1	Time constants in the signalling procedure		
5.6.2	Timing between the signalling directions in MS		
5.6.3	Timing of call acknowledgement on calling channel		
5.6.4	Timing of transmission of frames 10b, 10c, 11a, 11b and 12		
5.6.5	Timing of seizure on traffic channel		
5.6.6	Autonomous time-out		
<hr/>			
5.7	TRANSCEIVER INTERFACE	Rev 95-10-04	Ch. 5.7 (2)
5.7.1	RF power control in MS		
5.7.1.1	MTX controlled maximum RF output power		
5.7.1.2	Autonomous power control in MS		
5.7.2	RF frequency control		
5.7.3	Audio muting		
5.7.4	RF carrier detector		

6.	SYSTEM TESTS	Rev 95-10-04	Ch. 6 (9)
6.1	PERFORMANCE TESTS		
6.1.1	Signalling sensitivity measured by call reception probability		
6.1.2	Co-channel data rejection		
6.1.3	Adjacent RF-signal decoding degradation		
6.1.4	RF intermodulation decoding degradation		
6.1.5	Signalling sensitivity in presence of RF signal fading measured by call reception probability		
6.1.6	Data signal distortion		
6.1.7	Ability to interpret distorted data signals		
6.2	TIME CONSTANTS		
6.2.1	Receiver switching time to next channel including FFSK detection time		
6.2.2	Transmitter start-up times		
6.2.2.1	Definition		
6.2.2.2	Requirements		
6.2.3	Call acknowledgement on CC		
6.2.4	Transmitter awake time		
6.2.5	Switching time to ordered channel		
6.2.5.1	Definition		
6.2.5.2	Method of measurements		
6.2.5.3	Requirements		
6.2.6	Transient behaviour of the transmitter		
6.2.6.1	Definition		
6.2.6.2	Method of measurements		
6.2.6.3	Requirements		
6.3	ACCEPTANCE OF SIGNALS		
6.4	FUNCTIONAL TEST		

ANNEXES

Annex	Contents	Rev.	No. of pages
1	General information	95-10-04	4
2	Portable mobile station	95-10-04	5
3	Handheld mobile station (HMS)	95-10-04	6
4	Priority mobile station (PMS)	95-10-04	10
5	Payphone mobile station	95-10-04	6
6	Mobile station with MFT function	95-10-04	4
7	Mobile station with interface for external equipment	95-10-04	7
8	Mobile station with register recall function (Option)	95-10-04	3
9	Mobile station for combined use (HMS with booster)	95-10-04	1
10	Reserved		
11	Mobile station equipped with more than one handset and/or operational unit	95-10-04	2
12	Handheld mobile station with battery saving function	95-10-04	2
13	Reserved		
14	Not in 450 system		
15	Electrical interface used in the type test of the MS	95-10-04	1
16	Description of a random generator	95-10-04	3
17	Combined NMT-450/900 mobile station (CMS)	95-10-04	6
18	Requirements and test conditions for external equipment not specified elsewhere in MS specifications	95-10-04	6
19	Requirements concerning service mode and programming mode in NMT mobile stations	95-10-04	2
20	Requirements for NMT-mobile station equipped with a cordless handset	95-10-04	1
21	Data Mobile Station (DMS)	95-10-04	17
22	Mobile station integrated with a portable data terminal or personal computer. (CTMS)	95-10-04	6
23	Bar coding of subscription management related information	95-10-04	2

1. GENERAL

1.1 INTRODUCTION

NMT-450, the Nordic Mobile Telephone System in the 450 MHz -band is developed jointly by the Tele Danmark Mobil, Denmark, Telecom Finland, Finland, Tele-mobil, Norway and Telia Mobitel, Sweden in order to establish a compatible automatic public mobile telephone system in the Nordic countries.

This document specifies the requirements for the mobile stations (MS) in the system. For detailed information about the system and the interfaces between the system components, reference is made to NMT Doc 450-1, "System Description", which is necessary for the use of this document.

The mobile stations of the system are fully compatible with the land based part of the system, regardless of which Nordic country the mobile station happens to be in at the moment. All mobile stations are given full roaming capability in all participating countries.

The mobile stations are to be purchased or leased by the subscribers. They must, however, be type approved by the **type approval authority** in the country of the subscriber. In specifying the requirements for type approval, one basic aim has been that to the subscribers, the system shall appear as similar as possible to the fixed telephone network. This applies both to the use of the mobile station, the reliability of signalling, charging and to the services offered.

1.1.1 System concepts

With reference to the detailed system description, NMT Doc 450-1, the following lines are intended only as a very brief introduction to the system.

The interface between the system and the fixed telephone network is contained in the mobile telephone exchange (MTX). The base stations (BS) are connected to the MTX which controls the traffic to and from the mobile stations. The switching functions are performed by the MTX.

The base stations are grouped into traffic areas. An MTX may control one or more traffic areas.

At every base station, one channel is used as calling channel and is marked with a special identification signal. One or several of the other channels, when free, are marked with a free traffic channel identification signal. Stand-by mobile stations in an area under a base station are locked to the calling channel. "To minimise the possibility for illicit use of mobile stations, an authentication procedure will take place on all mobile originated calls. The MS shall also be able to answer an authentication procedure during conversation. This will be used to authenticate the MS as a B-subscriber when charging of B-subscriber is used."

1.1.2 Radio frequencies

The radio frequencies where the NMT-450 system will operate consist of the bands 453-457,5 MHz and 463-467,5 MHz which will be used for the paths mobile station to base station and base station to mobile station, respectively. With a channel separation of 25 kHz, these bands accommodate 180 channels.

In order to reduce the inconvenience of having a conversation interrupted when moving from one base station coverage area to another, the system is designed to switch calls in progress from one base station to another base station, controlled by the same MTX.

A mobile station will upon command from the MTX reduce its transmitter output power in the neighbourhood of a base station in order to reduce interference

1.1.2.1 Extended band (optional, subject to national regulation)

Futhermore as an option the NMT-450 system is allowed to operate in the following extension band:

452.500-452.975 MHz; MS transmit, BS receive

462.500-462.975 MHz; MS receive, BS transmit

These bands accommodate 20 channels

1.1.3 Call set-up procedures

1.1.3.1 Call to mobile station

Calls to all kinds of mobile stations are sent out in parallel over all base stations in the traffic area in which the mobile station is believed to operate. When a mobile station has received a calling signal containing its identification, it returns a call acknowledgement on the return frequency of the calling channel, upon this MTX allocates a traffic channel on the base station where the mobile station has answered the call. The channel number is received by the mobile station, which then switches to the allocated channel. Thereafter, all exchanges of signals between MTX and the mobile station take place on the traffic channel.

Alternatively the MTX may order the mobile station to search for a free marked traffic channel after having received the acknowledgement on a base station where all traffic channels are occupied.

"In situations where charging of B-subscriber is used, the MS shall be ready to answer an activating authentication procedure during conversation."

1.1.3.2 Call from mobile station

When an ordinary mobile subscriber initiates a call, the mobile station automatically hunts for and locks to a free marked traffic channel, on which all signals are exchanged and the conversation takes place. For mobile stations with added subscriber identity security, a special authentication procedure will take place before the conversation can start.

1.1.4 Switching call in progress

During a call a continuous out of band supervisory signal (\emptyset -signal) is generated at the BS (on order from MTX) and sent to the MS, where it is looped back to the BS. The returned \emptyset -signal is detected and evaluated by the BS. Then it is decided if the transmission quality (signal to noise ratio integrated over a certain period of time) necessitates switch-over to another BS. Information about switch-over is then sent to the MTX.

The MTX orders the BS and also the surrounding BS's to perform signal strength measurements on the radio channel on which the MS is transmitting. For signal strength measuring all BS's are equipped with an all-channel monitor receiver (SR). Information about the measurement results enables the MTX to decide to which BS (if any) the call shall be transferred.

The measuring action is also performed by the BS at the beginning of a call in order to determine whether the used BS is suitable.

This measurement is also used to determine whether the received signal from MS is higher than a certain level, in which case the MTX orders the MS to change to a lower transmitter output power level.

1.2 MOBILE STATION UNITS

The mobile station consists of 3 major functional units:

- Transceiver unit (including circuits for duplex operation);
- Operational controls unit;
- Logic and control unit.

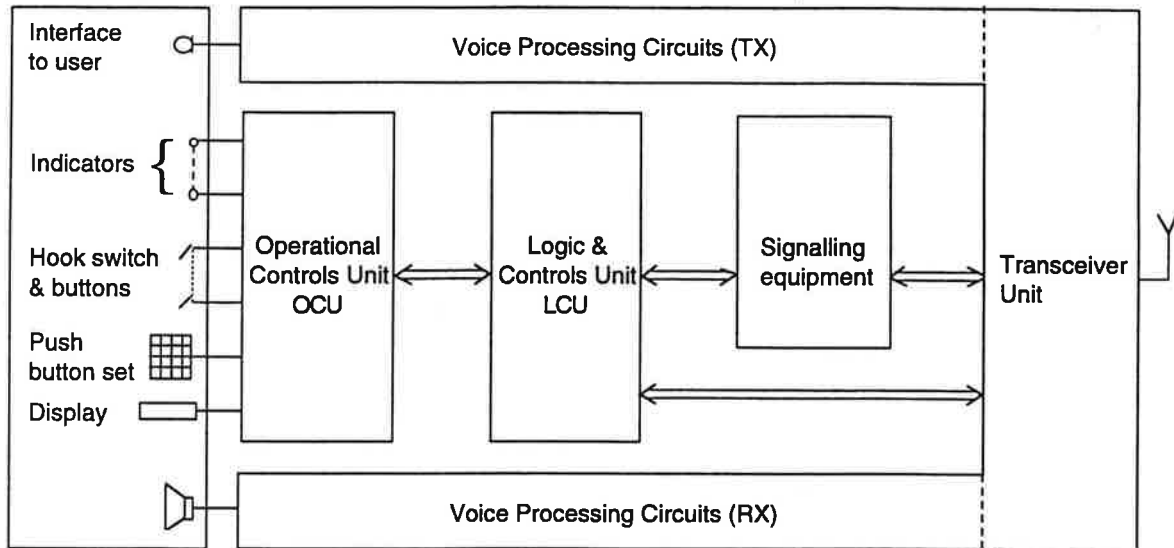

Fig. 1.1

In the physical realisation of the equipment, the different functional units may be integrated into single packages.

1.2.1 Transceiver Unit

The transceiver unit provides signalling and voice transmission and reception.

The RF band consists of a lower and an upper frequency segment. The lower frequency segment contains 180 transmitting channels with a channel separation of 25 kHz and the upper frequency segment contains the corresponding 180 receiving channels. The duplex separation is 10 MHz.

Channel numbers with corresponding center frequencies in NMT-450

Channel No.	in BS in MS	TX-frequency RX-frequency	RX-frequency TX-frequency
Ordinary channels:			
1		463,000 MHz	453,000 MHz
2		463,025 MHz	453,025 MHz
.			
.			
180		467,475 MHz	457,475 MHz

The LF output of the transceiver may be audio signals which are passed to the Operational Controls Unit, or coded signalling information which is passed to the Logic and Control Unit for decoding and appropriate processing.

1.2.2 Operational Controls Unit

The Operational Controls Unit provides the interface between the user and the NMT-450-system. This functional unit, described in Chapter 3 and 4, includes a handset, push-button set, hands-free audio capability and all mobile station controls, indicators and tone signals with which the user interacts.

1.2.3 Logic and Control Unit

The Logic and Control Unit, described in Chapter 5, functions as the master control for the mobile station and encodes and decodes the digital signalling used on the radio path and decides the appropriate action to be taken.

Some of the functions of the Logic and Control Unit are:

- * Decoding orders from the MTX such as:
 - alerting the user to an incoming call (ringing order)
 - channel command
 - adjusting the transceiver output power
 - identity and authentication request
 - releasing the MS at completion of a call or forced release.
 - calculation in a dedicated security chip of SRES and B-key on basis of the received RAND
 - encryption of the dialled digits based on the calculated B-key

- * Receiving general identification signals from the MTX such as:
 - traffic area identification
 - calling channel identification
 - free traffic channel identification

- * Evaluating and ordering the necessary steps to be taken by the mobile station

- * Encoding the signalling information to the MTX such as:
 - call initiation from MS (identification and authentication)
 - clearing signal when terminating a call
 - updating roaming information
 - dialled digits, encrypted or not, for call origination

- * Providing subscriber signalling information such as:
 - ringing signal
 - roaming alarm
 - malfunction alarm
 - service indicator
 - call received indicator

1.2.4 Signalling equipment

The signalling equipment is described in Chapter 5 and NMT Doc 450-1.

1.3 GENERAL CONDITIONS

1.3.1 General requirements

1.3.1.1 Marking of the equipment

The functions of all pilot lamps, terminals and controls as well as the positions of the controls shall be clearly indicated on the equipment.

The equipment shall be clearly marked with the make, type designation and serial number. This rule shall apply also to the sample handed in for type approval.

The marking shall be mechanically firm and durable and may, for example, be made by means of engraving, embossing or application of a metal plate.

Furthermore, the Operational Controls Unit shall be provided with a plate which shows the mobile telephone number.

The above mentioned markings will be subject to type approval, see Annex 1.

1.3.1.2 Warming up period

At the latest one minute after having been switched on to the power supply, the equipment shall be fully ready for operation, which shall be taken to mean that all requirements laid down in these present specifications shall be fulfilled.

1.3.2 Terminals

1.3.2.1 Test terminals

For test purposes the mobile station shall be provided with test terminals or other means e.g. supplementary unit, to make it possible to measure the requirements laid down in this specification.

1.3.2.2 Antenna terminal

The antenna terminal is the interface between the antenna and the mobile station including the duplex filter.

1.3.2.3 Voice input and output terminals

The mobile station shall be provided with the necessary terminals for the measurements specified in Chapter 2. Impedance's and signal levels at these terminals shall be declared by the manufacturer.

1.3.2.4 Arrangement for testing

It is required that the MS, inside the cabinet, shall be provided with an arrangement for test purposes which makes it possible to activate the MS in speech condition on any of the radio channels. It shall only be accessible for service and test personnel,

The arrangement shall overrule the autonomous time out device.

The method to be used to select a channel and activate the MS shall be declared by the manufacturer.

Reference is made to paragraph 4.5 and to Annex 19.

1.3.2.5 External equipment

External equipment may be connected to the MS via a separate interface unit and/or connector. See Annex 7 and Annex 18.

1.3.3 Test of the equipment

1.3.3.1 Application of the test conditions

For all requirements specified in these specifications, type approval measurements shall be carried out under the normal test conditions described in paragraph 1.3.4. If so specified, the test shall also be carried out under the extreme test conditions mentioned in paragraph 1.3.5.

1.3.3.2 Power supply

During the type approval tests, the power supply of the equipment shall be replaced by an external power source capable of producing power supply voltages as described in paragraphs 1.3.4.2 and 1.3.5.2. The internal impedance of the power source shall be low enough for its effect on the test results to be negligible.

The power supply voltage shall be measured at the input terminals of the equipment.

If the equipment is provided with a permanently connected power cable, the power supply voltage shall be measured at the point of connection of the power cable to the equipment.

In equipment with incorporated batteries, the power source shall be applied as close to the battery terminals as practicable.

During the testing the power supply voltage shall be maintained within a tolerance of $\pm 3\%$ relative to the voltage at the beginning of the test.

1.3.4 Normal test conditions

1.3.4.1 Normal temperature and humidity

The normal temperature and humidity conditions for tests shall be any convenient combination of temperature and humidity within the following ranges:

Temperature $+15^{\circ}\text{C}$ to $+35^{\circ}\text{C}$
Relative humidity 20% to 75%

1.3.4.2 Normal test power source

Mains voltage

The normal test voltage for equipment to be connected to the mains shall be the nominal mains voltage. For the purpose of these specifications, the nominal voltage shall be the declared voltage or any of the declared voltages for which the equipment was designed.

Regulated lead-acid battery power sources of vehicles.

If the radio equipment is intended for operation from the usual types of regulated lead-acid battery power source of vehicles, the normal test voltage shall be 1,1 times the nominal voltage of the battery (6 volts, 12 volts, etc.).

Other power sources.

For operation from other power sources or types of battery (primary or secondary), the normal test voltage shall be that declared by the equipment manufacturer. The MS shall be protected against reversed polarity from the power source.

1.3.5 Extreme test conditions

1.3.5.1 Temperatures at testing under extreme conditions

At testing under extreme conditions, the measurements shall be made in accordance with paragraph 1.3.5.3 at the temperatures of -25°C and $+55^{\circ}\text{C}$.

1.3.5.2 Power supply voltages at testing under extreme conditions

Regulated lead-acid battery power supplies for use in motor vehicles

If the radio equipment is intended for operation from the usual types of regulated lead-acid battery power supply of motor vehicles, measurements shall be made at power supply voltages of 1,3 and 0,9 times the nominal voltage of the battery (6 volts, 12 volts, etc.).

Mains voltage

The extreme test voltage for equipment to be connected to an AC mains source shall be the nominal mains voltage $\pm 10\%$.

Other power sources

The lower extreme test voltages for equipment with power sources using primary batteries shall be as follows:

- 1) For the Leclanché type of battery:
0,85 times the nominal voltage of the battery;
- 2) For the mercury type of battery:
0,9 times the nominal voltage of the battery;
- 3) For other types of primary batteries:
end point voltage declared by the equipment manufacturer.

For equipment using other power sources, or capable of being operated from a variety of power sources, the extreme test voltages shall be those agreed between the equipment manufacturer and the testing authority and shall be recorded with the results.

1.3.5.3 Procedure for tests at extreme temperatures

Test procedure

Before measurements are made, the equipment shall have reached thermal balance in the test chamber. The equipment shall be switched off during the temperature stabilising period. If the thermal balance is not checked by measurements, a temperature stabilising period of at least one hour, or such a period as may be decided by the testing authority, shall be allowed. The sequence of measurements shall be chosen, and the humidity content in the test chamber shall be controlled so that excessive condensation does not occur.

Before tests at the upper temperature, the equipment shall be placed in the test chamber and left until thermal balance is attained. The equipment shall then be switched on in the transmit condition for a period of half an hour after which the equipment shall meet the specified requirements.

For tests at the lower temperature, the equipment shall be left in the test chamber until thermal balance is attained, then switched to the standby or receive condition for a period of one minute, after which the equipment shall meet the specified requirements.

1.3.5.4 Storage conditions

The mobile station shall withstand storage temperatures between -40°C and $+70^{\circ}\text{C}$, for at least 24 hours without damage at each extreme temperature. The relative humidity at normal temperature is between 35 to 75 %.

1.3.6 Arrangement for test signals applied to the antenna terminal for receiver testing purposes

Sources of test signals connected to the antenna terminal shall be arranged in such a way that the impedance presented is 50 ohms. This requirement shall also be met if more than one signal source is applied simultaneously.

The levels of the test signals shall be expressed in terms of the E.M.F. at the antenna terminal.

1.3.7 Artificial antenna (dummy load)

Test of the transmitter shall be carried out with a non-radiating non-reactive load of 50 ohms connected to the antenna terminal.

1.3.8 Test modulations

1.3.8.1 Normal test modulation

For normal test modulation, the modulation frequency shall be 1 kHz and the resulting frequency deviation shall be $\pm 3,0$ kHz. The test signal shall be substantially free from amplitude modulation.

1.3.8.2 Data test modulation

Normal data test modulation is defined as the carrier frequency modulated with frame 15 (see NMT Doc 450-1) to give a mean frequency deviation of $\pm 3,5$ kHz. This corresponds to peak deviation $\pm 2,8$ kHz for 1200 Hz and $\pm 4,2$ kHz for 1800 Hz.

1.3.8.3 Supervisory signal modulation

Normal supervisory signal test modulation is defined as the carrier frequency modulated with a signal of frequency 4015 Hz to give a frequency deviation of $\pm 0,3$ kHz.

1.3.9 Definitions of some measuring instruments

1.3.9.1 Adjacent channel power measuring receiver

The receiver for measuring the adjacent channel power shall fulfil the requirements given in CEPT Recommendation T/R 24-01.

1.3.9.2 Psophometric filter

The psophometric filter, which is used when so stated in some of the test measurements, shall fulfil the requirements specified in CCITT Recommendation P53A (psophometer for commercial telephone circuits).

1.3.9.3 SINAD meter

The SINAD meter needed for receiver measurements is specified in CEPT Recommendation T/R 24-01. The psophometric filter needed for SINAD(P)-ratio measurements (see paragraph 2.3.7.1) may be included in the SINAD meter.

1.3.10 Vibration test

The MS shall be tested together with the car cassette, if any, and with the handset placed in the cradle. The cassette and the cradle shall be fixed to the mounting table.

1.3.10.1 Vibration (Sweep)

- a) It is required that the equipment is designed to withstand a vibration test according to the IEC publication 68-2-6.

10-55 Hz $\pm 0,12$ mm displacement

55-150 Hz 15 m/s^2 acceleration.

Sweep rate: 1 octave per minute.

Duration: 2 hours in each 3 directions.

During the vibration test, the equipment shall not be in operation. After the test, the equipment shall fulfil the requirements specified in these technical specifications.

- b) Microphony test.

It is required that the equipment is designed to prevent microphonic effects.

During this test the equipment shall be operating while it is vibrating between 55-150 Hz with an acceleration of 15 m/s^2 and shall fulfil the requirements

laid down in paragraphs 2.2.15 and 2.3.19. The microphone in the handset is made in-operative during this test. The microphone is disconnected and replaced with a resistor equal to the resistance of the microphone.

1.3.10.2 Vibration (Random), alternative test

a) It is required that the equipment is designed to withstand a vibration test according to IEC publication 68-2-36, test Fdb.

10 - 20 Hz 0,02 g²/Hz

20 - 150 Hz -3 dB/octave

Total r.m.s value (10 - 150 Hz) : 1 g

Duration: 1 hour in each 3 directions

During the vibration test, the equipment shall not be in operation. After the test the equipment shall fulfil the requirements specified in these technical specifications.

b) Functional test

It is required that the equipment is designed to prevent microphonic effects.

During this test, the equipment shall be operating. The vibration level shall be -6 dB relative the level stated in clause a).

The handset is removed from the vibration stand during this test.

The requirements are specified in paragraphs 2.2.15 and 2.3.19.

1.3.11 Test site and general arrangements for measurements involving the use of radiated fields

1.3.11.1 Test site

The test site shall be on a reasonably level surface or ground.

At one point on the site, a ground plane of at least 5 metres in diameter shall be provided. In the middle of this ground plane, a non conducting support, capable of rotation through 360° in the horizontal plane, shall be used to support the test sample at 1,5 metres above the ground plane. The test site shall be large enough to allow the erection of a measuring or transmitting antenna at a distance of 1/2 or 3 metres whichever is the greater. The distance actually used shall be recorded together with the results of the test carried out on the site.

Sufficient precautions shall be taken to ensure that reflections from extraneous objects adjacent to the site, as well as ground reflections, do not degrade the measurement results.

1.3.11.2 Test antenna

When the site is used for radiation measurements, the test antenna is used to detect both the radiation from the test sample and the substitution antenna. This antenna is mounted on a support such as to allow the antenna to be used in either horizontal or vertical polarisation and for the height of its centre above ground to be varied over the range 1–4 metres. Preferably a test antenna with pronounced directivity should be used. The size of the test antenna along the measurement axis shall not exceed 20% of the measuring distance.

For radiation measurements, the test antenna is connected to a test receiver, capable of being tuned to any frequency under investigation and of measuring accurately the relative levels of signals at its input.

1.3.11.3 Substitution antenna

The substitution antenna shall be a $1/2$ dipole, resonant at the frequency under consideration, or a shortened dipole, calibrated to the $1/2$ dipole. The centre of this antenna shall coincide with the reference point of the test sample it has replaced. This reference point shall be the volume centre of the sample when its antenna is mounted inside the cabinet, or the point where an outside antenna is connected to the cabinet.

The distance between the lower extremity of the dipole and the ground shall be at least 30 cm.

The substitution antenna shall be connected to a calibrated signal generator when the site is used for radiation measurements and to a calibrated measuring receiver when the site is used for measurement of receiver characteristics. The signal generator and the receiver shall be operating at the frequencies under investigation and shall be connected to the antenna through suitable matching and balancing networks.

1.3.11.4 Alternative indoor site

When the frequency of the signals being measured is higher than 80 MHz, an indoor site may be used. If this alternative site is used, this shall be recorded in the test report.

The measurement site may be a laboratory room with a minimum area of 6 metres by 7 metres and at least 2,7 metres in height. Apart from the measuring apparatus and the operator, the room shall be as free as possible from reflecting objects other than the walls, floor and ceiling.

An example of arrangements are shown in Fig.1.2

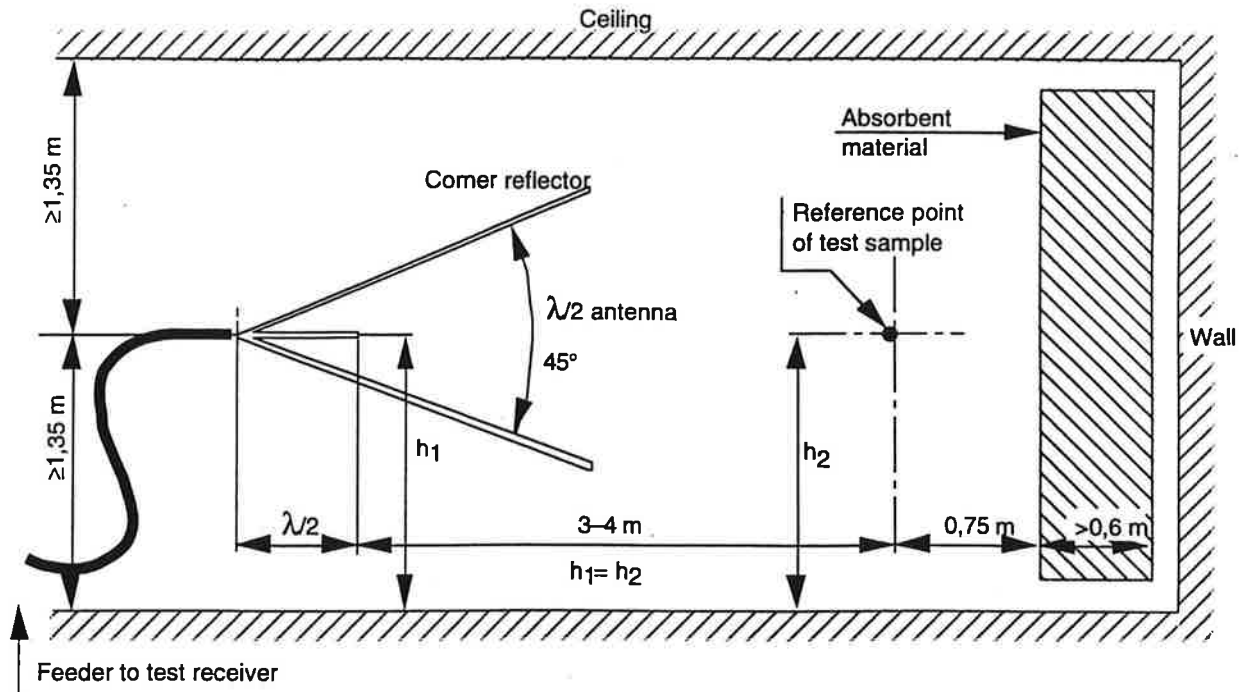

Fig. 1.2 Indoor site arrangement (shown for horizontal polarisation)

The potential reflections from the wall behind the equipment under test are reduced by placing a barrier of absorbent material in front of it. The corner reflector around the test antenna is used to reduce the effect of reflections from the opposite wall and from the floor and ceiling in the case of horizontally polarised measurements.

Similarly, the corner reflector reduces the effects of reflections from the side walls for vertically polarised measurements.

For the lower part of the frequency range (below approx. 175 MHz) no corner reflector or absorbent barrier is needed.

For practical reasons, the $\lambda/2$ antenna may be replaced by an antenna of constant length, allowing it to be used at frequencies corresponding to a length between $\lambda/2$ and λ , as long as the sensitivity is sufficient. In the same way, the distance of $\lambda/2$ to the apex may be varied.

The test antenna, test receiver, substitution antenna and calibrated signal generator are used in a way similar to that of the general method.

To ensure that errors are not caused by the propagation path approaching the point at which phase cancellation between direct and the remaining reflected signals occurs, the substitution antenna shall be moved through a distance of ± 10 cm in the direction of the test antenna as well as in the two directions perpendicular to this first direction. If these changes of distance cause a signal change of greater than 2 dB, the test sample should be resited until a change of less than 2 dB is obtained.

1.3.12 Receiver rated audio output power

The rated audio output power shall be the maximum power, declared by the manufacturer, for which all the requirements in clause 2.3 of these specifications are met. With normal test modulation, the audio output shall be measured in a resistive load, simulating the load with which the receiver normally operates. The value of this load shall be declared by the manufacturer.

2. TRANSCEIVER UNIT

2.1 GENERAL

The requirements in this chapter cover the transceiver unit consisting of the transmitter/receiver, including circuits for duplex operation modulator/demodulator, pre-emphasis/de-emphasis networks, syllabic companders, muting circuit and electroacoustic transducers with associated circuits.

The mobile station shall be equipped with syllabic companders. (Reference: Recommendation G.162, CCITT IXth Plenary Assembly, Melbourne, 14-25 November 1988, Blue Book, Vol. III. 1). The compression ratio shall be 2:1. The compressor part shall be located between the microphone circuits and the pre-emphasis network, and the expander part shall be located between the de-emphasis network and the handset earpiece (and loudspeaker) circuits. The manual volume control shall be located after the expander.

2.2 TRANSMITTER

Unless otherwise specified, all requirements in section 2.2, shall be carried out and fulfilled in conversation mode (duplex operation). The modulation signal shall be applied to the voice input terminal of the transmitter, i.e. at a point between the syllabic compressor stage and the pre-emphasis network, from an oscillator having a suitable impedance according to paragraph 1.3.2.3. However, if provision is made for disabling the compressor, i.e. locking it to a fixed amplification, the test signal may be applied to a test point located before the compressor stage.

2.2.1 Frequency range and channel separation

The MS transmitter works on frequencies from 453,000 MHz to 457,475 MHz, giving the corresponding MS receiver frequencies from 463,000 MHz to 467,475 MHz.

2.2.1.1 Extension band (optional, subject to national regulations)

As an option the MS is allowed to work on the following frequencies:
452.500-452.975 MHz; MS transmit,
462.500-462.975 MHz; MS receive

2.2.2 Number of channels

The number of channels in the NMT-450-system is 180 channels. Channel No.1 is the lowest in frequency (in transmitter 453,000 MHz, in receiver 463,000 MHz) and channel No.180 is the highest in frequency (in transmitter 457,475 MHz, in receiver 467,475 MHz).

2.2.2.1 Extension band (optional, subject to national regulations)

The number of channels in the extension band is 20. Channel No. 181 is the lowest in frequency (in receiver 462,500 MHz, in transmitter 452,500 MHz) and channel No. 200 is the highest in frequency (in receiver 462,975 MHz, in transmitter 452,975 MHz).

2.2.3 Frequency error

2.2.3.1 Definition

The frequency error of the transmitter is the difference between the measured carrier frequency and its nominal value.

2.2.3.2 Method of measurement

The carrier frequency shall be measured without modulation and with the MS antenna terminal connected to an artificial antenna. The measurements shall be made under normal and extreme test conditions.

2.2.3.3 Requirements

The frequency error of the transmitter steady-state frequency shall not exceed $\pm 2,5$ kHz under normal as well as extreme test conditions

2.2.4 Transmitter carrier power

2.2.4.1 Definition

The transmitter carrier power is the mean power delivered to the artificial antenna during a radio frequency cycle, without modulation.

2.2.4.2 Method of measurement

The antenna terminal shall be connected to an artificial antenna, and the power delivered to this artificial antenna shall be measured. The measurements shall be made under normal test conditions and under extreme test conditions.

2.2.4.3 Requirements

The available steady-state carrier output power at the antenna terminal into an artificial antenna shall be within the range $15\text{ W} \pm 1.5\text{ dB}$ or optional $7\text{ W} \pm 1.5\text{ dB}$ at normal and extreme conditions. Regarding portable mobile stations and handheld mobile stations ref. is made to annex 2 and annex 3 respectively.

2.2.4.4 Load test

The transmitter shall be submitted to load tests with continuous transmission during a period of 30 minutes.

- The change in the transmitter output power relative to actual output power at 50 ohm load shall not exceed 2 dB during a load test when the MS is loaded with a resistive impedance giving a standing wave ratio of 2. The test shall be carried out under normal test conditions.
- Without *being damaged*, the MS shall withstand a load test when it is loaded with a resistive impedance giving a standing wave ratio of 2. The test shall be carried out under extreme test conditions.

Furthermore the MS shall withstand, without being damaged, a load test when the MS is loaded with an arbitrary load. This is done by leaving the antenna terminal open and by short circuiting it for at least one minute in each case. For handheld mobile stations see Annex 3.

2.2.5 Transmitter carrier power control

The transmitter shall be capable of changing the transmitter carrier output power as controlled by the Logic and Control Unit to $-10 \text{ dB} \pm 3 \text{ dB}$ (medium power) and $-20 \text{ dB} \pm 3 \text{ dB}$ (low power) relative to nominal carrier output power 15 W (high power) at normal and extreme test conditions.

2.2.6 Carrier on/off condition and carrier rise/decay time

Transmitter start-up time and transmitter awake time are defined in Chapter 6.

2.2.7 Transmitter channel switching time

For definition, method of measurement and requirements, see Chapter 6.

2.2.8 Spurious emissions

2.2.8.1 Definition

Spurious emissions are emissions at frequencies other than those of the carrier and sidebands associated with normal test modulation.

The level of spurious emissions shall be measured as:

- a) their conducted power level in an artificial antenna;
- b) their effective radiated power when radiated by the cabinet and structure of the equipment (also known as "cabinet radiation"), as well as the integral or carrier case antenna if applicable.

2.2.8.2 Method of measuring the conducted power level

Spurious emissions shall be measured as the power level of any discrete signal delivered into a 50 ohms load. This may be done by connecting the antenna terminal through an attenuator to a spectrum analyzer or selective voltmeter, or by monitoring the relative levels of the spurious signals delivered to an artificial antenna.

The transmitter shall be unmodulated and the measurements made over the frequency range 100 kHz to 4000 MHz, except for the channel on which the transmitter is intended to operate and its adjacent channels.

The measurements shall be repeated with the transmitter modulated with normal test modulation.

The same measurements shall also be made when the MS transmitter is in reduced power mode.

2.2.8.3 Method of measuring the effective radiated power

On a test site, fulfilling the requirements of paragraph 1.3.11, the sample shall be placed at the specified height on a non-conducting support. The transmitter shall be operated at the carrier power as specified under paragraph 2.2.4, delivered to an artificial antenna without modulation.

Radiation of any spurious components shall be detected by the test antenna and receiver, over the frequency range 30-4000 MHz, except for the channel on which the transmitter is intended to operate and its adjacent channels.

At each frequency at which a component is detected, the sample shall be rotated to obtain maximum response and the effective radiated power of that component shall be determined by a substitution measurement.

The measurements shall be repeated with the test antenna in the orthogonal polarisation plane.

The measurements shall be repeated with the transmitter modulated by normal test modulation.

2.2.8.4 Requirements

The following requirements shall be fulfilled during full and reduced power modes.

The power of any spurious emission shall not exceed the values given below:

	100 kHz to 1000 MHz	1000 MHz to 4000 MHz
Tx. Operating	0,25 μ W	1 μ W
Standby	2 nW	20 nW

2.2.9 Frequency deviation

The frequency deviation is the maximum difference between the instantaneous frequency of the modulated radio frequency signal and the unmodulated carrier.

2.2.9.1 Maximum permissible frequency deviation without supervisory signal

2.2.9.1.1 Definition

The maximum permissible frequency deviation without supervisory signal is the maximum value of frequency deviation stipulated in these specifications.

2.2.9.1.2 Method of measurement

The frequency deviation shall be measured at the antenna terminal of the MS connected to an artificial antenna, by means of a deviation meter capable of

measuring the maximum deviation, including that due to any harmonics and intermodulation products which may be generated in the transmitter.

The modulation frequency without the supervisory signal shall be varied from 20 Hz to 25 kHz. The level of this test signal shall be 20 dB above the level of the normal test modulation.

During the test an unmodulated RF signal with a level of 60 dB (μ V) E.M.F. is applied to the receiver input through the combining network.

2.2.9.1.3 Requirements

The maximum permissible frequency deviation shall be $\pm 4,7$ kHz.

2.2.10 Limiting characteristics of modulator

2.2.10.1 Definition

The limiting characteristics of the modulator expresses the capability of the transmitter to be modulated close to the maximum permissible frequency deviation as defined in paragraph 2.2.9.

2.2.10.2 Method of measurement

A test signal with a frequency of 1000 Hz and without the supervisory signal shall be applied to the voice input circuit of the transmitter.

The level shall be adjusted so that the frequency deviation is $\pm 1,0$ kHz. The level is then increased by 20 dB and the frequency deviation is again measured. If the compressor is used as a combined compressor/limiter and the compressor part cannot be disconnected for testing purposes, the audio pressure shall be increased by 40 dB.

The measurements shall be carried out under normal test conditions and extreme test conditions.

During the test an unmodulated RF signal with a level of 60 dB (μ V) E.M.F. is applied to the receiver input through the combining network.

2.2.10.3 Requirements

The frequency deviation shall be between $\pm 3,7$ kHz and $\pm 4,7$ kHz.

2.2.11 Adjacent channel power

2.2.11.1 Definition

The adjacent channel power is that part of the total power output of a transmitter under defined conditions of modulation, which falls within the bandwidth of a receiver of the type normally used in the system and operating in either of the adjacent channels. This power is the sum of the mean power

produced by the modulation, hum and noise of the transmitter. The adjacent channel is separated 25 kHz from the nominal frequency.

2.2.11.2 Method of measurement

The adjacent channel power shall be measured with a power-measuring receiver which conforms to paragraph 1.3.9.1.

The transmitter shall be operated at full carrier power determined in paragraph 2.2.4 under normal test conditions. The antenna terminal shall be linked to the input of the "receiver" by a connecting device such that the impedance presented to the MS is 50 ohms and the level at the "receiver" input is appropriate.

The transmitter shall be simultaneously modulated with a signal of 1250 Hz and the supervisory signal (4015 Hz) with $\pm 0,3$ kHz deviation.

During the test an unmodulated RF signal with a level of 3 to 100 dB (μ V) E.M.F. is applied to the antenna terminal.

The signal of 1250 Hz shall be adjusted to a level 20 dB higher than that required to produce $\pm 3,0$ kHz deviation (without supervisory signal). The "receiver" shall be tuned to the nominal frequency of the transmitter and the variable attenuator in the "receiver" shall be adjusted to a value p dB such that a meter reading of the order of 5 dB above the "receiver" noise level is obtained.

The "receiver" shall then be tuned to the nominal frequency of one of the adjacent channels (25 kHz up or down) and the variable attenuator shall be adjusted to a value q dB such that the same meter reading is obtained.

The ratio of adjacent channel power to carrier power is the difference between the attenuator settings p and q. The adjacent channel power is determined by applying this ratio to the carrier power.

The measurement shall be repeated with normal data test modulation as in paragraph 1.3.8.2.

The measurements shall be repeated on the other adjacent channel. The measurement shall be repeated using all the power levels mentioned in paragraph 2.2.5.

2.2.11.3 Requirements

The adjacent channel power shall not exceed the power level corresponding to 70 dB below the actual power of the transmitter, or 0,2 microwatt at reduced output power.

2.2.12 Audio-frequency response of the transmitter

2.2.12.1 Definition

The audio-frequency response is the frequency deviation of the transmitter carrier as a function of modulation frequency at constant level of the modulation signal.

2.2.12.2 Method of measurement

A modulation signal at a frequency of 1000 Hz is applied to the voice input circuit. Its amplitude is adjusted to such a level that a frequency deviation of ± 1 kHz is obtained. The frequency deviation is measured while the frequency of the modulation signal is varied between 150 Hz and 25 kHz, its level being kept constant at the same value as at 1000 Hz. The measurement shall be made without the supervisory signal.

During the test an unmodulated RF signal with a level of 60 dB (μ V) E.M.F. is applied to the receiver input through the combining network.

2.2.12.3 Requirements

The audio frequency response shall have a 6 dB/octave pre-emphasis between 300 Hz to 3400 Hz. Higher and lower frequencies shall be attenuated.

The tolerances are given in Fig. 2.2

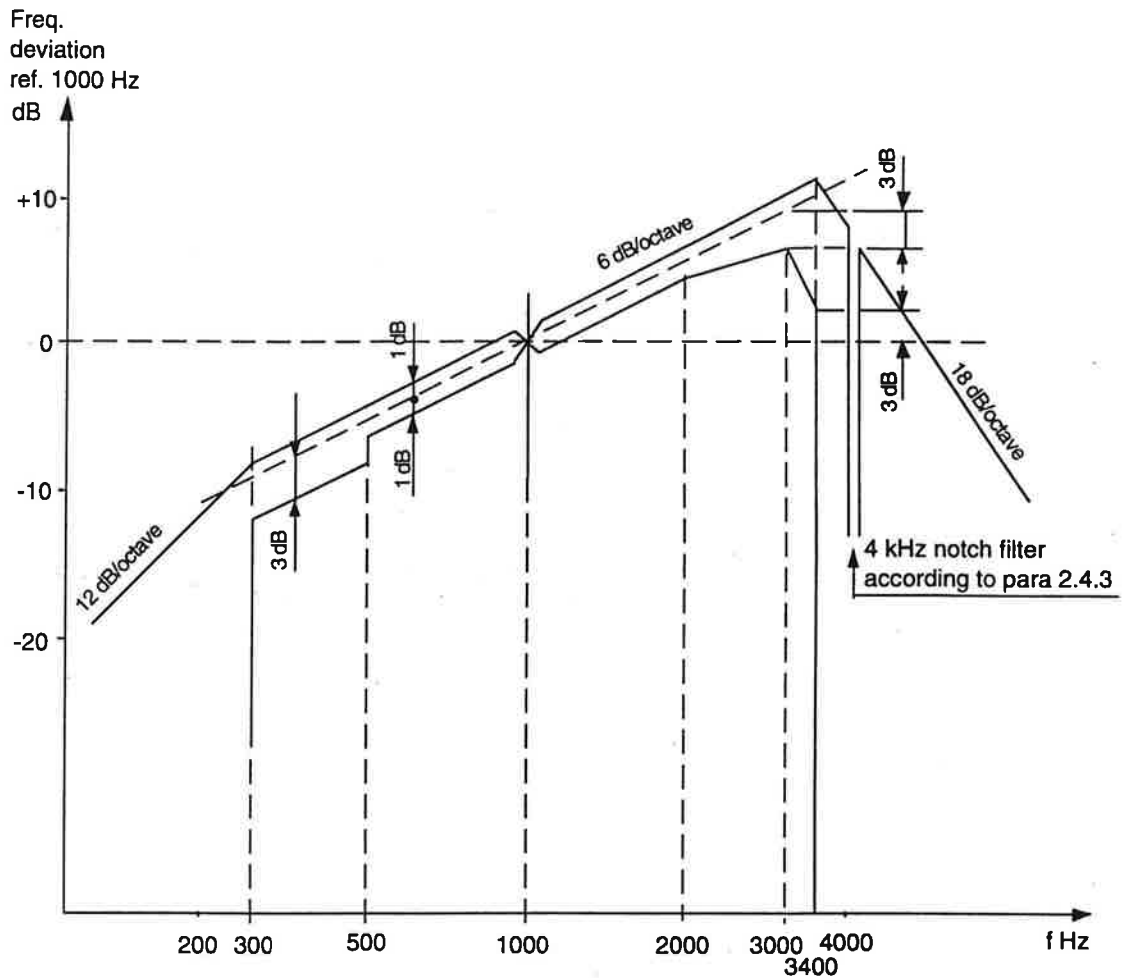

Fig. 2.2 Audio frequency response of transmitter

2.2.13 Harmonic distortion factor in transmission

2.2.13.1 Definition

The harmonic distortion factor of a transmitter modulated by an audio-frequency signal is defined as the ratio expressed as a percentage of the r.m.s. voltage of all the harmonic components of the fundamental audio frequency to the total r.m.s. voltage of the signal after linear demodulation.

With the method described below, when a distortion analyzer is used, the hum and noise components are included in the distortion measurement.

2.2.13.2 Method of measurement

The radio frequency signal produced by the transmitter is applied, by means of a suitable coupler, to a linear demodulator equipped with a de-emphasis network of 6 dB per octave above 300 Hz. The response of this network may be flat but not falling below 300 Hz. At normal test conditions, this radio frequency signal is modulated successively at frequencies of 300, 500 and 1000 Hz with a constant modulation index of 3 (the modulation index is the

ratio of the frequency deviation to the modulating frequency) producing 3.0 kHz deviation at the frequency of 1000 Hz.

The harmonic distortion factor of the audio frequency signal is measured at extreme test conditions at 1000 Hz with a frequency deviation of $\pm 3,0$ kHz.

During the test an unmodulated RF signal with a level of 60 dB (μ V) E.M.F. is applied to the receiver input through the combining network.

2.2.13.3 Requirements

The harmonic distortion shall not exceed 5%.

2.2.14 Relative audio-frequency intermodulation product level of the transmitter

2.2.14.1 Definition

The relative intermodulation-product level of the transmitter is the ratio, expressed in decibels, of

the level of an unwanted component of the output signal caused by the presence of two modulating signals as a result of non linearity in the transmitter

to

the level of one of the wanted output signals measured at the output of a deviation meter.

2.2.14.2 Method of measurement

a) Connect the equipment as shown in Fig. 2.3

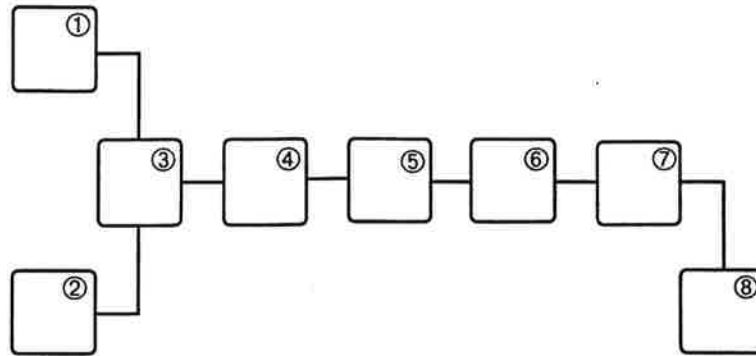

1. Audio-frequency generator no. 1
2. Audio-frequency generator no. 2
3. Audio-frequency combining unit
4. MS transmitter under test
5. Artificial antenna (50 ohm load)
6. Coupler/attenuator
7. Deviation meter
8. Audio-frequency spectrum analyzer or selective voltmeter

Fig. 2.3

b) In the absence of an output from audio-frequency generator (2), adjust the audio frequency generator (1) to produce $\pm 2,3$ kHz frequency deviation at a modulating frequency, F_1 , of 1000 Hz.

Record the output level of the audio-frequency signal generator.

c) Reduce the output of generator (1) to zero and adjust the output of generator (2) to produce $\pm 2,3$ kHz frequency deviation at a modulating frequency: F_2 , of 1600 Hz.

d) Restore the output of generator (1) to the level recorded according to b) and measure the relevant intermodulation products with the selective voltmeter.

Note: The deviation meter shall be provided with a de-emphasis network of 6 dB per octave.

During the test an unmodulated RF signal with a level of 60 dB (μ V) E.M.F. is applied to the receiver input through the combining network.

2.2.14.3 Requirements

The relative intermodulation product level shall not exceed -20 dB relative to F_2 .

2.2.15 Residual modulation

2.2.15.1 Definition

The residual modulation of the transmitter is the ratio, expressed in dB, of the audio frequency noise level produced after radio frequency signal demodulation in the absence of modulation by the wanted signal, by the spurious effects of the power supply system, by the modulator or by other causes, to the audio frequency level produced by normal test modulation applied to the transmitter.

2.2.15.2 Method of measurements

- a) The normal test modulation is applied to the transmitter. The RF signal produced by the transmitter is applied by means of a suitable coupler to a linear demodulator.

The demodulator is equipped with a de-emphasis network of 6 dB per octave.

All precautions shall be taken to prevent the measurement results from being affected by emphasis at the low audio frequencies of the internal linear demodulator noise.

Measurements shall be carried out on the demodulator output signal by means of an r.m.s. voltmeter equipped with a psophometric filter described in paragraph 1.3.9.2.

The modulation is then removed and the level of the residual audio-frequency output signal is again measured.

This test shall be repeated under conditions as specified in paragraph 1.3.10 b.

- b) The same method as a) above, but without the psophometric filter at the output.

In this case, the measurements are carried out by means of a peak-to-peak voltmeter.

During the test an unmodulated RF signal with a level of 3 to 100 dB (μ V) E.M.F. is applied to the antenna terminal.

2.2.15.3 Requirements

For case a) the residual modulation shall not exceed -40 dB under normal conditions and -30 dB under conditions as specified in paragraph 1.3.10.b.

For case b) the residual modulation shall not exceed -20 dB under normal conditions and -14 dB under conditions as specified in paragraph 1.3.10.b.

2.2.16 Transmitter audio muting

2.2.16.1 Definition

An input muting device controlled by the Logic and Control Unit shall be provided. The muting device shall prevent the voice input to cause interference during the data transmission in the audio band.

2.2.16.2 Method of measurements

The measurements shall be performed in local mode.

A modulation signal at a frequency of 1000 Hz is applied to the voice input circuit. Its amplitude is adjusted to such a level that a frequency deviation of ± 3 kHz is obtained. The RF signal produced by the transmitter is applied by means of a suitable coupler to a linear demodulator. The demodulator is equipped with a de-emphasis network of 6 dB per octave.

The demodulated audio-frequency is measured by audio-frequency spectrum analyzer. The audio-path from the device under test is then closed by local command and the modulation signal is kept on the same level and the attenuation is measured.

The test may be repeated at a modulation frequency where the audio noise is lowest.

During the test an unmodulated RF signal with a level of 60 dB (μ V) E.M.F. is applied to the antenna terminal.

2.2.16.3 Requirements

The muting shall be capable of causing at least 40 dB attenuation in the audio path. The data transmission shall not begin until the muting has reached an attenuation of 40 dB.

2.3 RECEIVER

All requirements in section 2.3, with the exception of paragraph 2.3.14, shall be fulfilled in duplex operation. The measurements shall be carried out in conversation mode at the voice output terminal of the receiver, i.e. at a point between the de-emphasis network and the expander stage, by using a load mentioned in paragraph 1.3.12. However, if provision is made for disabling the expander, i.e. locking it to a fixed attenuation, the test point may be located after the expander stage. The transmitter shall be modulated with a 400 Hz tone giving a frequency deviation of $\pm 3,0$ kHz unless otherwise stated.

2.3.1 Frequency range and channel separation

The MS receiver works on frequencies from 463,000 MHz to 467,475 MHz, with a channel separation of 25 kHz. The duplex separation is 10 MHz, giving the corresponding MS transmitter frequencies from 453,000 MHz to 457,475 MHz.

2.3.1.1 Extension band (optional, subject to national regulations)

As an option the MS is allowed to work on the following frequencies:
452.500-452.975 MHz; MS transmit,
462.500-462.975 MHz; MS receive

2.3.2 Number of channels

The number of channels in the NMT-450 is 180. Channel No. 1 is the lowest in frequency (in receiver 463,000 MHz, in transmitter 453,000 MHz) and channel No. 180 is the highest in frequency (in receiver 467,475 MHz, in transmitter 457,475 MHz).

2.3.2.1 Extension band (optional, subject to national regulations)

The number of channels in the extension band is 20. Channel No. 181 is the lowest in frequency (in receiver 462,500 MHz, in transmitter 452,500 MHz) and channel No. 200 is the highest in frequency (in receiver 462,975 MHz, in transmitter 452,975 MHz).

2.3.3 Duplex separation

The duplex receive channels are assigned on a one to one relationship with the transmit channels, and a constant separation of 10 MHz.

2.3.4 Receiver detection and switching time

Definition, method of measurement and requirements are given in Chapter 6.

2.3.5 Reduced channel locking capability

See paragraph 5.2.1.2

2.3.6 RF carrier detector

The detector level shall be fixed and the opening level shall be
-2 dB (μ V) E.M.F. ± 2 dB at normal test conditions and
-2 dB (μ V) E.M.F. ± 4 dB at extreme test conditions.

2.3.7.1 RF-sensitivity

2.3.7.1.1 Definition

The sensitivity of the receiver is the minimum RF-signal level at the antenna terminal which, at the nominal frequency of the receiver and modulated with normal test modulation, will produce a power at the voice output circuit at least 50% of the rated output power and a SINAD-ratio of 20 dB measured through the psophometric filter (see paragraph 1.3.9.2).

The SINAD-ratio is the ratio of signal+noise+distortion to noise+distortion. The SINAD(P)-ratio is the SINAD-ratio measured through the psophometric filter.

2.3.7.1.2 Method of measurements

A signal at the nominal frequency of the receiver and with normal test modulation shall be applied to the antenna terminal. The SINAD meter (see paragraph 1.3.9.3) and a psophometric filter shall be connected to the voice output circuit. Where possible, the receiver volume control shall be adjusted to give 50% of the rated output power and, in the case of stepped volume controls, to the first step that provides an output power of at least 50% of the rated output power.

The test signal input level at the antenna terminal shall be 0 dB(μ V) E.M.F. under normal test conditions and +3 dB(μ V) E.M.F. under extreme test conditions. In both cases the SINAD(P)-ratio is measured.

Under extreme test conditions, a variation of the receiver output power of ± 3 dB from the value obtained under normal test conditions may be allowed.

2.3.7.1.3 Requirements

The SINAD(P)-ratio shall be at least 20 dB in both cases. The maximum RF-signal level difference between any arbitrary channel to get the same SINAD(P)-ratio shall not exceed 2 dB at normal test conditions and 3 dB at each extreme test condition.

2.3.7.2 Receiver duplex sensitivity degradation

2.3.7.2.1 Definition

Receiver duplex sensitivity degradation is a reduction of the receiver sensitivity when the transmitter is switched on.

2.3.7.2.2 Method of measurement

The MS shall be in the condition of receiving ringing order. The reference signal level, E_0 is the lowest signal level when the MS generates ringing locally as a response to 5a (L=9) with 95% reception probability. The MS shall then be in the speech condition and the lowest signal level for a successful switching call in progress, E_S , shall be noted. The level E_S is the lowest signal level for which switching call in progress is successful with 95% probability during speech condition. The difference, $E_S - E_0$, in dB is a measure of the receiver duplex sensitivity degradation.

The measurement is carried out with a VSWR 1:2.

2.3.7.2.3 Requirements

The receiver duplex sensitivity degradation shall not exceed 3 dB for all transmitter output levels.

2.3.8 Co-channel rejection

2.3.8.1 Definition

The co-channel rejection is a measure of the capability of the receiver to receive a wanted modulated signal without exceeding a given degradation due to the presence of an unwanted modulated signal, both signals being at the nominal frequency of the receiver.

2.3.8.2 Method of measurement

Two input signals shall be connected to the antenna via a combining device. The wanted signal shall have normal test modulation. The unwanted signal shall be modulated with a frequency of 400 Hz with a deviation of ± 3 kHz. Both input signals shall be at the nominal frequency of the receiver and the measurement repeated for displacements of the unwanted signal of up to ± 3 kHz.

The transmitter shall be unmodulated during the test.

Initially the unwanted signal shall be switched off and the level of the wanted signal shall be adjusted to 3 dB (μV) E.M.F. The unwanted signal shall then be switched on.

The level of the unwanted signal shall be adjusted until the SINAD(P)-ratio measured at the voice output circuit is reduced to 20 dB.

The co-channel rejection ratio is expressed as the ratio in dB of the level of the unwanted signal to the level of the wanted signal at the antenna terminal for which a SINAD(P)-ratio = 20 dB at the voice output circuit occurs.

2.3.8.3 Requirements

The co-channel rejection ratio at any of the specified signal displacements shall be between 0 dB and -8 dB.

2.3.9 Adjacent channel selectivity

2.3.9.1 Definition

The adjacent channel selectivity is a measure of the capability of the receiver to receive a wanted modulated signal without exceeding a given degradation due to the presence of an unwanted signal which differs in frequency from the wanted signal by an amount equal to the channel separation. The adjacent channel is separated 25 kHz from the nominal frequency.

2.3.9.2 Method of measurement

Two signals shall be applied to the antenna terminal via a combining device. The wanted signal shall be tuned to the nominal frequency of the receiver and be modulated with normal test modulation. The unwanted signal shall be at the nominal frequency of the upper adjacent channel (+25 kHz) and be modulated with a 400 Hz tone to a frequency deviation of ± 3 kHz.

The mobile station transmitter shall be unmodulated during the test.

Initially the unwanted signal shall be switched off and the level of the wanted signal shall be adjusted to 3 dB (μV) E.M.F. under normal test conditions and 6 dB (μV) E.M.F. under extreme test conditions. The unwanted signal shall then be switched on and its level adjusted until the SINAD(P)-ratio measured at the voice output circuit is reduced to 20 dB.

The measurement shall be repeated with the unwanted signal at the nominal frequency of the lower adjacent channel (-25 kHz).

The ratios expressed in dB of the level of the unwanted signal to the level of the wanted signal are determined. The adjacent channel selectivity shall then be the lower value of the two ratios.

2.3.9.3 Requirements

The adjacent channel selectivity shall not be less than 70 dB under normal test conditions and not less than 60 dB under extreme test conditions.

2.3.10 Adjacent channel selectivity in the interleaved channel (12,5) kHz (NOT IN NMT 450 SYSTEM)

2.3.11 Spurious response rejection

2.3.11.1 Definition

The spurious response rejection is a measure of the capability of the receiver to discriminate between the wanted modulated signal at the nominal frequency and an unwanted signal at any other frequency than the wanted and adjacent channels.

2.3.11.2 Method of measurement

Two input signals shall be applied to the antenna terminal via a combining device. The wanted signal shall be at the nominal frequency of the receiver and be modulated with normal test modulation.

Initially the unwanted signal shall be switched off and the wanted input signal adjusted to 3 dB (μV) E.M.F. The unwanted signal shall be switched on and modulated with a 400 Hz tone to a frequency deviation of ± 3 kHz. The input level of the unwanted signal shall be 83 dB (μV) E.M.F. The frequency shall then be varied over the frequency range from 100 kHz to 2000 MHz.

At any frequency at which a response is obtained, the input level of the unwanted signal shall be adjusted until the SINAD(P)-ratio of the voice output circuit is reduced to 20 dB.

The spurious response rejection is expressed as the ratio in dB of the input voltage of an unwanted signal and the input voltage of the wanted signal when SINAD(P)-ratio of 20 dB, as mentioned above, is obtained.

The transmitter shall be unmodulated during the test.

2.3.11.3 Requirements

The spurious response rejection shall be at least 70 dB.

2.3.12 Intermodulation rejection

2.3.12.1 Definition

The intermodulation rejection is a measure of the capability of the receiver to receive a wanted signal without exceeding a given degradation due to the presence of two unwanted high level signals. One channel separation equals 25 kHz.

2.3.12.2 Method of measurement

Three signals shall be applied to the antenna terminal via a combining device. The wanted signal A shall be tuned to the nominal frequency of the receiver and modulated to normal test modulation. The unwanted signal B shall be tuned to a frequency 50 kHz above the nominal frequency of the wanted signal and shall be unmodulated. The unwanted signal C shall be tuned to a frequency 100 kHz above the frequency of the wanted signal and be modulated with a 400 Hz tone to a frequency deviation of ± 3 kHz.

The level of the wanted signal A shall be adjusted to 3 dB (μ V) E.M.F. The level of the two unwanted signals B and C shall be maintained equal and increased in level until the SINAD(P)-ratio measured at the voice output circuit is 20 dB.

The frequencies of signals B and C may be slightly adjusted to get maximum degradation of the SINAD(P)-ratio and their levels adjusted until the SINAD(P)-ratio is again 20 dB.

The measurement shall be repeated with the two unwanted signals B and C tuned to 50 kHz and 100 kHz, respectively, below the frequency of the wanted signal.

The intermodulation rejection is expressed as the level in dB of the unwanted signals and the wanted signal when the SINAD(P)-ratio of 20 dB as mentioned above, is obtained. The transmitter shall be unmodulated during the test.

2.3.12.3 Requirements

The intermodulation rejection shall not be less than 67 dB.

2.3.13 Blocking

2.3.13.1 Definition

Blocking is a change (generally a reduction) in the wanted output power of a receiver or a reduction of the SINAD(P)-ratio due to an unwanted signal on another frequency.

2.3.13.2 Method of measurement

Two input signals shall be applied to the antenna terminal via a combining device. The wanted signal shall be at the nominal frequency of the receiver and shall have normal test modulation. Initially the unwanted signal shall be switched off and the input level of the wanted signal adjusted to 3 dB (μ V) E.M.F.

Where possible, the output power of the wanted signal at the voice output circuit shall be adjusted to 50% of the rated output power and in the case of stepped volume controls to the first step that provides an output power of at

least 50% of the rated output power. Then the unwanted signal is switched on. The unwanted signal shall be unmodulated, and the frequency shall be varied between +1 MHz and +10 MHz, and also between -1 MHz and -10 MHz, relative to the nominal frequency of the receiver. The input level of the unwanted signal, at all frequencies in the specified ranges, shall be adjusted such that the unwanted signal causes:

- a) a reduction of 3 dB in the audio frequency output power of the wanted signal, or
- b) a reduction of the SINAD(P)-ratio to 20 dB which ever occurs first.

This input level is the blocking level at the frequency concerned. The mobile station transmitter shall be unmodulated during the test.

2.3.13.3 Requirements

The blocking level for any frequency within the specified ranges shall not be less than 90 dB (μ V) E.M.F. except at frequencies where spurious responses are found.

2.3.14 Spurious emissions

2.3.14.1 Definition

Spurious emissions are any emissions from the receiver and the transmitter in carrier "off" condition.

The level of spurious emissions shall be measured as:

- a) their conducted power level in an artificial antenna
and
- b) their effective radiated power when radiated by the cabinet and structure of the equipment (also known as "cabinet radiation"), as well as the integral or carrier case antenna if applicable.

2.3.14.2 Method of measuring the conducted power

Conducted spurious emissions shall be measured as the power of any discrete signal at the antenna terminal of the mobile station. The antenna terminal is connected to a spectrum analyser or selective voltmeter having an input impedance of 50 ohms and the receiver is switched on.

If the measuring receiver is not calibrated in terms of absolute power, the power of any detected components shall be determined by a substitution method using a signal generator.

The measurements shall be carried out within at least the frequency range 100 kHz to 4000 MHz.

2.3.14.3 Method of measuring the effective radiated power

On a test site fulfilling the requirements of paragraph 1.3.11, the sample shall be placed at the specified height on a non-conducting support. The receiver shall be operated from a power source via a radio-frequency filter to avoid radiation from the power leads. The antenna terminal shall be connected to a 50 ohms resistive load. Radiation of any spurious components shall be detected by the test antenna and measuring receiver over the frequency range from 30 MHz to 4000 MHz.

At each frequency at which a spectral component is detected, the sample shall be rotated to obtain maximum response and the effective radiated power of that component shall be determined by a substitution measurement.

The measurement shall be repeated with the test antenna in the orthogonal polarisation plane.

2.3.14.4 Requirements

The power of any spurious emission in the range 100 kHz to 1000 MHz shall not exceed 2 nW, and in the range 1000 MHz to 4000 MHz shall not exceed 20 nW.

2.3.15 Harmonic distortion ratio

2.3.15.1 Definition

The harmonic distortion ratio at the voice output circuit is the r.m.s. value of the voltage of all harmonics divided by the r.m.s. value of the total signal voltage.

2.3.15.2 Method of measurement

Test signal of 60 dB (μ V) E.M.F. and 100 dB (μ V) E.M.F. at the nominal frequency of the receiver shall be applied successively to the antenna terminal.

At each measurement the volume control of the receiver shall be set in such a manner that the power at the voice output circuit is equal to the rated output power of the receiver.

The test signal shall be modulated successively with 300, 500 and 1000 Hz tones to frequency deviations of $\pm 0,9$ kHz, $\pm 1,5$ kHz and $\pm 3,0$ kHz respectively.

Under extreme test conditions tests shall be carried out at the nominal frequency of the receiver as well as ± 1 kHz from the nominal frequency. In this case, the input signal is modulated only with a 1000 Hz tone to a

frequency deviation of $\pm 3,0$ kHz. The transmitter shall be unmodulated during the test.

2.3.15.3 Requirements

At all audio frequencies used in the measurement and under all test conditions, the harmonic distortion ratio shall not exceed 5%.

2.3.16 Relative audio frequency intermodulation product level

2.3.16.1 Definition

The relative intermodulation product level is the ratio, expressed in dB, of the level of an unwanted component of the output signal caused by the presence of two modulating signals as a result of non linearity in the receiver, to the level of one of the wanted output signals measured at the voice output circuit.

2.3.16.2 Method of measurement

Two audio frequency generators, A and B, shall be connected via a combining device to the modulation input of the radio frequency signal generator.

Adjust the radio-frequency test signal to the nominal frequency of the receiver and the test signal level successively to 20 dB, 60 dB and 100 dB (μ V) E.M.F.

In the absence of an output from audio-frequency generator B, adjust the audio-frequency generator A to produce a $\pm 2,3$ kHz frequency deviation at a modulation frequency of 1000 Hz. Where possible, adjust the output power to 50% of the rated output power. In case of stepped volume controls, the first step that provides an output power of at least 50% of the rated output power, shall be used. Record the output level of generator A.

Reduce the output of generator A to zero and adjust the output of generator B 1600 Hz. to produce a $\pm 2,3$ kHz frequency deviation at a modulation frequency of

Restore the output of generator A to the level recorded and measure the level of the 1600 Hz component and of the intermodulation products at the voice output circuit.

The transmitter shall be unmodulated during the test.

2.3.16.3 Requirements

The relative audio frequency intermodulation product level shall not exceed -20 dB relative to 1600 Hz.

2.3.17 Amplitude characteristics of the receiver limiter

2.3.17.1 Definition

The amplitude characteristics of the receiver limiter is the relationship between the level of a specified modulated input signal and the level of the audio frequency signal at the output of the receiver.

2.3.17.2 Method of measurement

A signal at the nominal frequency of the receiver with normal test modulation and at a level of 3 dB (μV) E.M.F. shall be applied to the antenna terminal. Where possible the audio frequency output power shall be adjusted to 25% of the rated output power. In case of stepped volume control the first step that provides an output power of at least 25% of the rated output power shall be used. The input signal shall be increased to 100 dB (μV) E.M.F. and the audio frequency output power shall be measured again.

2.3.17.3 Requirements

At the change in the input power specified above, the change in the output power shall not exceed 3 dB.

2.3.18 AM-suppression

2.3.18.1 Definition

AM-suppression is the capability of the receiver to suppress amplitude modulated signals. It is expressed as the ratio in dB of the audio power at the voice output circuit with normal test modulation to the audio power with a specified amplitude modulation.

2.3.18.2 Method of measurement

A test signal at a level of 20 dB (μV) E.M.F. and 60 dB (μV) E.M.F. at the nominal frequency of the receiver shall be applied to the antenna terminal successively. The signal shall initially have normal test modulation and the receiver output power shall be set to the nominal output level. The normal test modulation shall then be replaced by amplitude modulation to 30% with a 1000 Hz tone. The audio power shall be measured again. It may be necessary to make this measurement with a selective voltmeter.

2.3.18.3 Requirements

The AM-suppression shall not be less than 30 dB.

2.3.19 Noise and hum

2.3.19.1 Definition

The "noise and hum" of the receiver is the ratio, expressed in dB, of the audio frequency noise and hum level resulting from the spurious effects of the power supply system or from other causes to the audio frequency power

produced by a medium-level RF signal modulated by normal test modulation applied to the antenna terminal.

2.3.19.2 Method of measurement

A test signal at a level of 30 dB (μ V) E.M.F. at a carrier frequency equal to the nominal frequency of the receiver and modulated to the normal test modulation, is applied to the antenna terminal. A psophometric filter is connected to the voice output circuit. The audio frequency output power control, if any, shall be adjusted to the rated output power.

This test shall be repeated under vibration, paragraph 1.3.10b.

The output signal is measured by an r.m.s. voltmeter.

The modulation is then removed and the audio frequency output level measurement is repeated.

The measurement shall be repeated using the same method as above but without the psophometric filter.

The output signal is measured by means of a peak-to-peak voltmeter.

2.3.19.3 Requirements

With the psophometric filter, the receiver "noise and hum" ratio shall not exceed -40 dB under normal test conditions and -30 dB under conditions as specified in paragraph 1.3.10.b.

Without the psophometric filter, the receiver "noise and hum" ratio shall not exceed -20 dB under normal test conditions, and -14 dB under conditions as specified in paragraph 1.3.10.b.

2.3.20 Audio frequency response

2.3.20.1 Definition

The audio frequency response of the receiver expresses the variations of the audio frequency output level as a function of the input signal modulation frequency at the input.

2.3.20.2 Method of measurement

A test signal of 60 dB (μ V) E.M.F at a frequency equal to the nominal frequency of the receiver is applied to the antenna terminal. A test signal shall have normal test modulation.

Where possible, the output power shall be adjusted to 50% of the rated output power. In case of stepped volume control, the first step that provides an output power of at least 50% of the rated output power shall be used. This setting is not altered during the test.

The frequency deviation at 1000 Hz is then reduced to ± 1 kHz.

The frequency deviation is maintained constant while the modulation frequency is varied between 20 and 5000 Hz.

The measurement is repeated with a test signal having a frequency equal to the nominal RF frequency of the receiver plus or minus 1,0 kHz.

The transmitter shall be unmodulated during the test.

2.3.20.3 Requirements

The audio level relative to the value at 1 kHz at constant frequency deviation shall be as given in Fig.2.4.

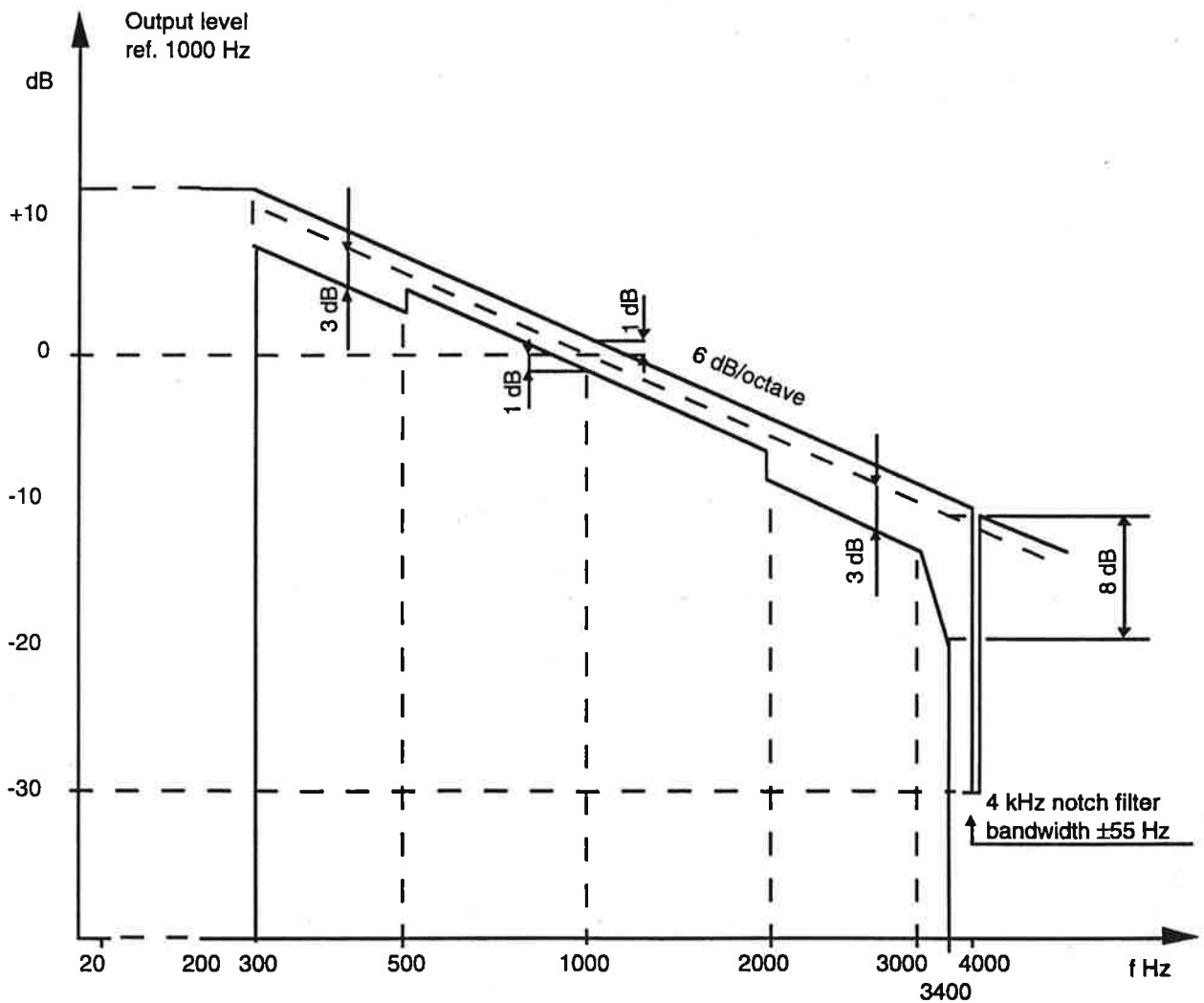

Fig. 2.4 Receiver audio output level as a function of modulation frequency at constant frequency deviation

2.3.21 Receiver audio muting

2.3.21.1 Definition

An output muting device controlled by the Logic and Control Unit shall be provided. The device mutes data signals measured at the voice output terminal of the receiver. See clause 5.5.4.

2.3.21.2 Method of the measurement

The MS is in NMT-mode. Initiate a call. In conversation state a test signal at a level of 60 dB (μ V) E.M.F. modulated with normal test modulation, is applied to the antenna terminal. A psophometric filter is connected to the voice output circuit. The audio frequency power control, shall be adjusted to the rated output power.

The output signal is measured by an r.m.s. voltmeter.

The modulation is then replaced by continues FFSK signalling (idle frame 6, less than 30 sec) and the audio output level measurement is repeated.

Connect the digital storage oscilloscope to the voice output circuit.

The FFSK signalling is then replaced by normal test modulation. The time from the end of the last frame sync until opening of audio path is measured. Check that the muting device is not reacting upon "signals" which are -18 dB \pm 3 dB below the nominal data signal. The call is terminated and the audio output level measurement is repeated on the calling channel. During this measurement the expander shall not be disabled.

2.3.21.3 Requirement

The muting of the data signals measured at the voice output terminal of the receiver shall be minimum 50 dB.

The requirement shall be fulfilled both in standby and conversation.

Opening of the audio path is delayed 277 ± 10 ms after reception of the last frame synchronization.

2.4 Ø-SIGNAL LOOP AND TRANSCEIVER COUPLING

2.4.1 Supervisory signal deviation

2.4.1.1 Definition

The supervisory signal (Ø-signal) as received and demodulated in the receiver is looped to the modulator without regeneration and shall produce a transmitter frequency deviation equal to the frequency deviation of the received supervisory signal.

2.4.1.2 Method of measurement

2.4.1.2.1 Calibration set up

A test signal at the normal frequency of the receiver shall be applied to the modulation analyzer. The signal shall be modulated with a 4000 Hz tone to a frequency deviation of ± 300 Hz. The modulation analyzer output level shall be measured.

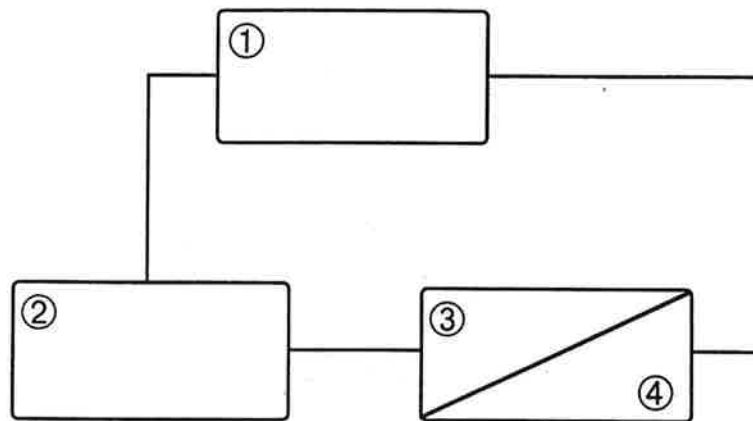

- 1 RF signal generator
- 2 Modulation analyzer
- 3 Selective voltmeter
- 4 LF generator

Fig. 2.5 Calibration set up

2.4.1.2.2 Measurement set up

Test signal of 10 dB (μ V) E.M.F. and 90 dB (μ V) E.M.F. at the nominal frequency of the receiver shall be applied successively to the antenna terminal. The test signal shall be modulated successively with 3945, 4000 and 4055 Hz tones to frequency deviation of ± 300 Hz.

The modulation analyzer output level shall be measured selectively and be recorded.

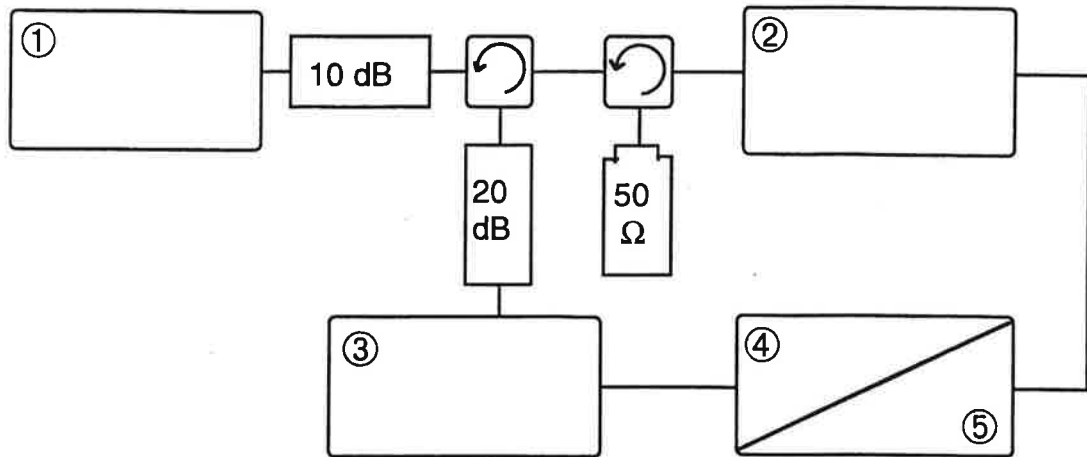

- 1 Device under test (MS)
- 2 RF signal generator
- 3 Modulation analyzer
- 4 Selective voltmeter
- 5 LF generator

Fig. 2.6 Measurement set up

2.4.1.3 Requirements

The transmitted supervisory signal (\emptyset -signal) shall not exceed $\pm 300\text{Hz} \pm 10\%$ deviation under all test conditions.

The supervisory signal deviation shall not be influenced by audio input.

Frequency = 4000 Hz continuous (± 55 Hz).

2.4.2 Transceiver coupling

2.4.2.1 RX-TX

2.4.2.1.1 Definition

Any coupling from the receive path to the transmit path must be sufficiently small to prevent excessive echo from returning to the base station, as specified in the following.

2.4.2.1.2 Method of measurement

The RF generator shall be modulated with a 1000 Hz tone giving a frequency deviation of ± 1 kHz. This level shall not be changed during the measurement. The compressor shall be disconnected.

During this measurement, the acoustic path between the handset receiver (earpiece) and microphone shall be blocked by connecting the handset receiver to an artificial ear.

2.4.2.1.3 Requirements

The ratio in dB between the frequency deviation of the transmitter signal and that of the received signal at any modulation frequency shall be attenuated in accordance with fig. 2.7.

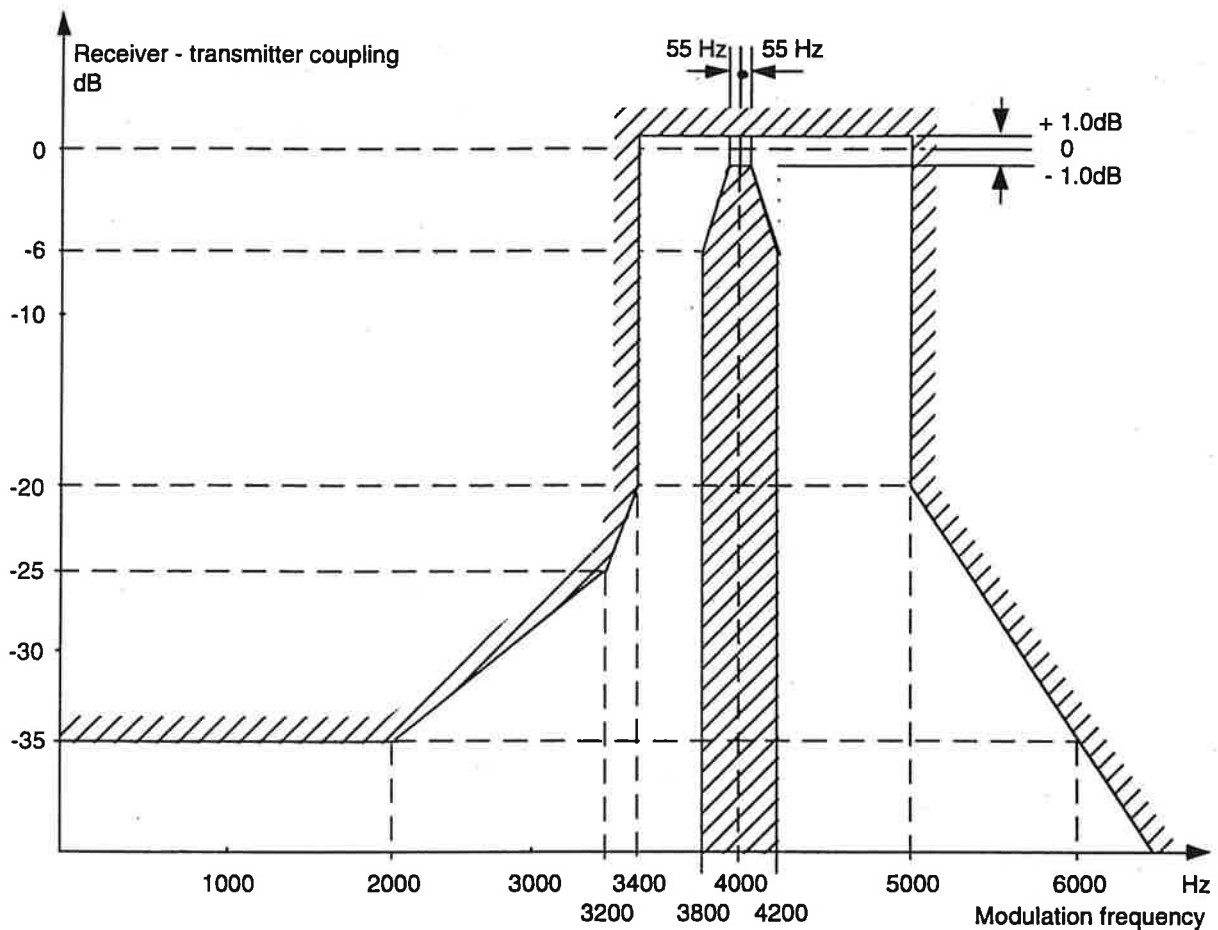

Fig. 2.7

2.4.2.2 TX-RX

2.4.2.2.1 Definition

Any coupling from the transmit path to the receive path must be sufficiently small as specified in the following.

2.4.2.2.2 Method of measurement

The transmitter shall be modulated with a 300 - 3400 Hz signal with constant level, giving a deviation of ± 1 kHz at 1000 Hz. The variation of the deviation in transmitter, and the output level of the receiver audio output circuits caused by the coupling from transmitter shall be recorded. A 60 dB (μ V) E.M.F. unmodulated RF input signal shall be simultaneously fed to the receiver input. The RF input signal shall then be modulated by a 300 - 3400 Hz signal, and the deviation shall follow that obtained by the transmitter. The output signal at the receiver output circuit shall be recorded. The two audio levels shall be compared at corresponding frequencies. The compander shall be disconnected.

2.4.2.2.3 Requirements

The coupling between transmitter path to receiver path at the receiver output shall be below -25 dB.

2.4.3 Interference in the \emptyset -signal frequency band

2.4.3.1 Definition

The interference level is the ratio, expressed in dB, of the level of unwanted component of the output signal, caused by the presence of the modulation in the received signal as a result of nonlinearity in the receiver and transmitter, to the level of the wanted \emptyset -signal measured at the output of the transmitter.

2.4.3.2 Method of measurement

The radio frequency signal produced by the transmitter is applied, by means of a suitable coupler, to a linear demodulator equipped with a filter according to Fig. 2.8, and measured with an r.m.s. voltmeter. Alternatively an audio spectrum analyser may be used.

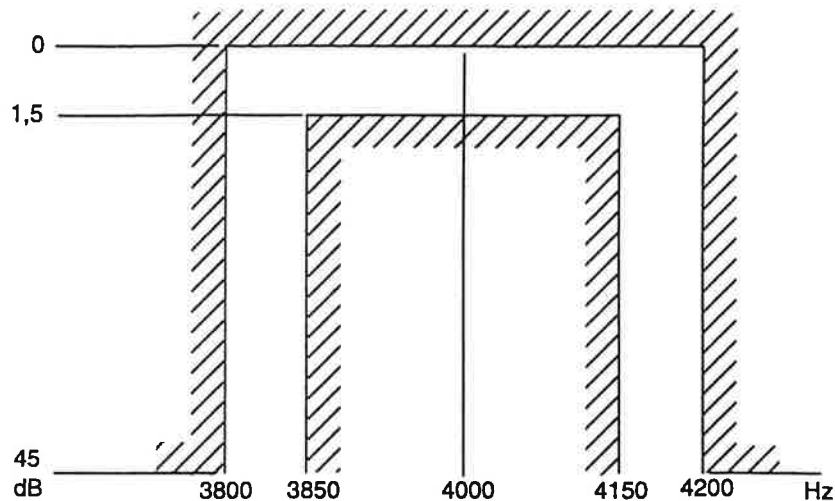

Fig. 2.8

A radio frequency signal at the nominal frequency of the receiver and with a level of 60 dB (μ V) E.M.F. is applied, by means of a suitable coupler, to the receiver input terminal. The radio frequency signal is modulated with \emptyset -signal to $\pm 0,3$ kHz deviation and the level of the looped \emptyset -signal is measured. Thereafter the \emptyset -signal modulation is removed.

- a) The receiver input radio frequency signal is then modulated to $\pm 1,5$ kHz deviation. The modulation frequency is varied between 300 Hz and 3400 Hz. The interference in the looped \emptyset -signal channel is measured.

The measurement is repeated at the deviation 3 dB above and 3 dB below the test modulation above.

The transmitter shall be unmodulated during the test.

- b) An acoustic test tone with a frequency of 1000 Hz is applied to the handset microphone. The level of the tone is adjusted so that a peak frequency deviation of the RF-carrier of ± 3 kHz is obtained.

Keeping the sound pressure at the microphone constant at its initiated level the frequency of the acoustic test signal is varied between 300 Hz and 5000 Hz, and the interference in the looped \emptyset -signal channel is measured.

The receiver input radio frequency signal shall be unmodulated during the test.

2.4.3.3 Requirements

The interference level in the looped \emptyset -signal channel shall not exceed in case a) -10 dB and in case b) -15 dB relative to the \emptyset -signal level.

2.4.4 Relative audio frequency intermodulation product level in the Ø-signal loop

2.4.4.1 Definition

The relative intermodulation product level is the ratio, expressed in dB, of the level of an unwanted component in the Ø-signal loop caused by the presence of two modulating signals as a result of nonlinearity in the receiver and transmitter, to the level of the wanted Ø-signal measured at the output of the transmitter.

2.4.4.2 Method of measurement

The radio frequency signal produced by the transmitter is applied, by means of a suitable coupler, to a linear demodulator equipped with a filter according to the figure below, and measured with an r.m.s. voltmeter. Alternatively an audio spectrum analyser may be used.

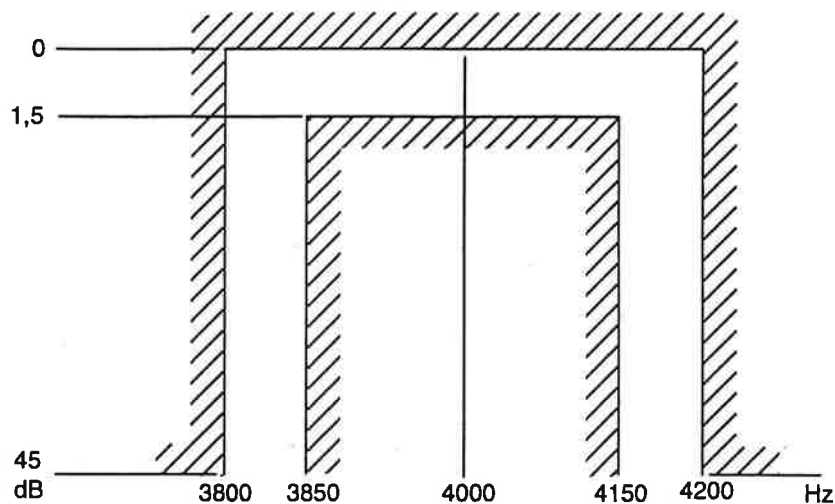

Fig. 2.9

A radio frequency signal at the nominal frequency of the receiver and with a level of 60 dB (μV) E.M.F. is applied, by means of a suitable coupler, to the receiver input terminal. The radio frequency signal is modulated with Ø-signal to $\pm 0,3$ kHz deviation and the level of the looped Ø-signal is measured. Thereafter the Ø-signal modulation is removed.

Two audio frequency generators, A and B, shall be connected via a combining device to the modulation input of the radio frequency signal generator.

Adjust the radio-frequency test signal to the nominal frequency of the receiver and the test signal level successively to 20 dB, 60 dB and 100 dB (μV) E.M.F.

2.5 VOICE PROCESSING REQUIREMENTS, TRANSMITTING

The CCITT Recommendations of the P-series referred to in this section are those in CCITT Blue Book, Vol. V, IXth Plenary Assembly, Melbourne, 14-25 November 1988.

The measurements described in this section shall be performed in local mode. The antenna terminal of the mobile station shall be connected, by means of an attenuator/coupler, to an ideal base station represented by a measuring set-up consisting of three parts (Fig. 2.10):

- 1: Deviation meter (modulation analyzer)
- 2: 6 dB/octave de-emphasis network
- 3: The expander part of a 2:1 syllabic compander with a nominal attack time of 3.0 msec and a nominal recovery time of 13.5 msec. The compander shall meet the requirements in CCITT Rec. G.162. However, the compander parameters shall be calibrated to an accuracy in line with laboratory instruments.

Note: The expander stage of the ideal base station used for type approval by the Nordic Administrations will be based on the circuit NE 570.

In section 2.5 the term "reference tone" shall mean a tone, transmitted through the system, with a frequency of 1000 Hz and producing a peak frequency deviation of ± 3 kHz. The term "reference level" shall, at any point, mean the level of the test tone at that point.



Fig. 2.10 Measuring set-up, transmission

When measuring the mobile station with deactivated compander, the expander circuit in point 3 above is bypassed.

The paragraphs below that do not apply when the compander is deactivated, are marked with (*).

2.5.1* Compression linearity

2.5.1.1 Definition

The compression linearity is the deviation from the linear relation between the input amplitude of the compressor and the output amplitude of an ideal base station.

2.5.1.2 Method of measurement

A test signal with a frequency of 1000 Hz shall be applied to a test point at the input of the compressor stage of the mobile station. Its amplitude shall be adjusted to the reference level. The ratio D_0 in dB between the amplitude of the input test signal and the amplitude at Point 1 of the measuring set-up in Fig. 2.10 shall be measured. The input amplitude shall subsequently be varied from +3 dB to -50 dB relative to its initial value. The ratio D between the input and the output amplitudes shall be recorded as a function of input amplitude.

Note: The compression ratio of the compressor of the mobile station is 2:1. This compression ratio is compensated by the expansion ratio of 1:2 of the expander of the measuring set-up.

2.5.1.3 Requirements

The maximum difference between D and D_0 shall be $\pm 1,0$ dB.

2.5.2* Transient response of the compressor

2.5.2.1 Definition

The definition of transient response shall be as in CCITT Rec. G.162, clause 7.

2.5.2.2 Method of measurement

The transient response of the compressor shall be measured with a 12 dB step of a test signal of 2000 Hz applied to the input of the compressor stage of the mobile station. The high and low level of the signal shall be respectively -22 dB and -34 dB relative to the reference level.

The envelope of the signal at Point 1 of the measuring set-up in Fig. 2.10 shall be recorded for an upward step.

The procedure shall be repeated for a downward step.

Note: The high and low level recommended in CCITT Rec. G.162, clause 7, are respectively -4 dB and -16 dB relative to the reference level. The values in this specification are chosen in order to avoid possible peak limiting in the radio path.

2.5.2.3 Requirements

The overshoot (positive or negative) shall be less than 20 % of the final value.

2.5.3* Attack time and recovery time of the compressor

2.5.3.1 Definition

The definition of attack time and recovery time shall be as in CCITT Rec. G.162, clause 7.

2.5.3.2 Method of measurement

The attack time and recovery time of the compressor shall be measured with a 12 dB step of a test signal of 2000 Hz applied to the input of the compressor stage of the mobile station. The high and low level of the signal shall be -22 dB and -34 dB relative to the reference level.

The envelope of the signal at Point 2 of the measuring set-up in Fig. 2.10 shall be recorded for an upward step of the test signal. The attack time as defined in CCITT Rec. G.162, clause 7, shall be measured.

The procedure shall be repeated for a downward step. The recovery time as defined in CCITT Rec. G.162, clause 7, shall be measured.

2.5.3.3 Requirements

The attack time shall be $3,0 \pm 2,0$ ms. The recovery time shall be $13,5 \pm 6,5$ ms.

2.5.4 Send frequency response

2.5.4.1 Definition

The send frequency response is the ratio in dB, as a function of test tone frequency, between the voltage of the signal at the output of an ideal base station and the nominal sound pressure of the artificial mouth when the microphone is positioned in the LRGP-position. By nominal sound pressure of the artificial mouth shall be meant the sound pressure in the mouth reference point in the absence of the microphone.

2.5.4.2 Method of measurement

The measuring set up shown in Fig. 2.10 shall be calibrated so that the r.m.s. voltage of the reference tone is 1 Volt at Point 1 (at point 2 with deactivated compander in MS). The sound source shall be an artificial mouth according to CCITT Rec. P.51. Section 2.

The level of an acoustic test tone shall be adjusted so that a sound pressure of -20 dBPa (-10 dBPa with deactivated compander in MS) at the mouth reference point (25 mm in front of the lip ring) is obtained. The handset shall subsequently be placed with the microphone in the LRGP position (CCITT Rec. P.76, Annex A). The level at Point 1 (at point 2 with deactivated compander in MS) of the measuring set-up in Fig. 2.10 shall be measured. This procedure shall be carried out in the frequency range from 150 Hz to 7000 Hz. If the mobile station is equipped with a noise cancelling device (paragraph 2.5.8) it shall be locked to its high gain position during this measurement.

2.5.4.3 Requirements

The send frequency response shall fall within the mask shown in Fig. 2.11. However, the acoustic-to-electric response may exceed the mask boundaries by up to 3 dB in a maximum of three arbitrary nonadjacent frequency intervals, each having a width of maximum one third of one octave.

Note: The mask may be transposed in the vertical direction. Fig. 2.11 Send frequency response

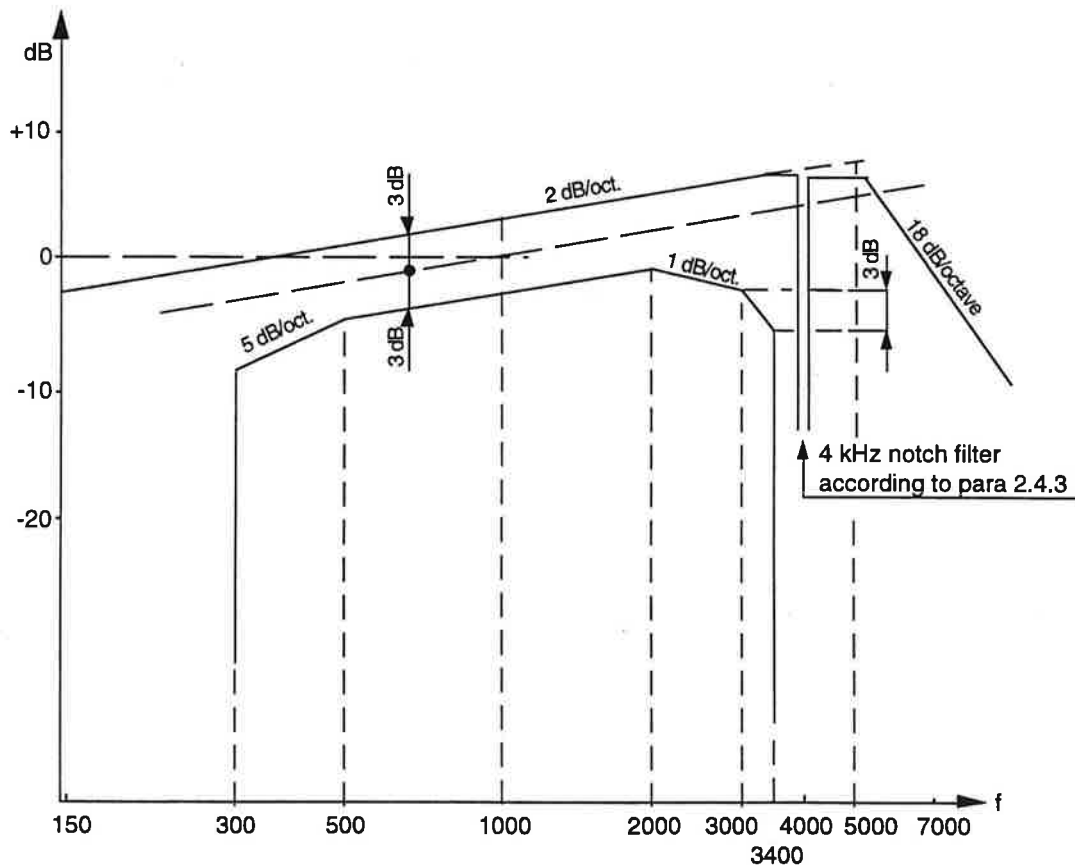

Fig. 2.11 Send frequency response

2.5.5 Send loudness rating

2.5.5.1 Definition

The send loudness rating of the mobile station is as defined in CCITT Rec. P.79, from the acoustic input of the handset microphone to the output of an ideal base station (Point 1 of Fig. 2.10) calibrated so that the amplitude of the reference tone is 1 Volt at that point.

2.5.5.2 Calculation method

The send loudness rating shall be calculated from the send frequency response function (Point 2.5.4) in the following manner:

Let i denote the 1/3 octave frequency number defined in the table below. Let S_{si} denote the send frequency response value expressed in dB V/Pa for frequency number i . (See paragraph 2.5.4.2).

Calculate the send loudness rating (SLR) from the following equation:

$$SLR = -57,1 \log_{10} \sum_{i=1}^{14} 10^{0,0175(S_{si} - W_{si})}$$

where the values for W_{si} are given in the table below.

Freq.no.(i)	Freq. Hz	Send W_{si}
1	200	76,9
2	250	62,6
3	315	62,0
4	400	44,7
5	500	53,1
6	630	48,5
7	800	47,6
8	1000	50,1
9	1250	59,1
10	1600	56,7
11	2000	72,2
12	2500	72,6
13	3150	89,2
14	4000	117,0

Note: In CCITT Rec. P.79 a bandwidth of 100 to 8000 Hz is used for calculating loudness rating. In these specifications a bandwidth of 200 to 4000 Hz is used.

2.5.5.3 Requirements

The send loudness rating SLR shall be 3,0 dB \pm 2 dB. With deactivated compander SLR shall be 0 dB \pm 3 dB.

2.5.6 Transmit distortion

2.5.6.1 Definition

The transmit harmonic distortion is defined as the ratio, expressed as a percentage, of the r.m.s. voltage of all the harmonic components of the fundamental audio frequency to the total r.m.s. voltage of the signal after linear demodulation and de-emphasis.

2.5.6.2 Method of measurement

An acoustic test tone with a frequency of 1000 Hz shall be applied to the handset microphone. Its sound pressure level shall be adjusted so that a peak frequency deviation of the RF-carrier of \pm 3,5 kHz is obtained. The harmonic distortion at Point 1 of the measuring set-up in Fig. 2.10 shall be measured. This procedure shall be repeated for a test tone with a frequency of 500 Hz modulated to a peak frequency deviation of \pm 3 kHz, and for a test tone with a frequency of 300 Hz modulated to a peak frequency deviation of \pm 1,5 kHz.

Note: The maximum undistorted acoustic pressure level provided by an artificial voice may be insufficient for this measurement. If so, a loudspeaker may be used.

2.5.6.3 Requirements

The harmonic distortion shall be less than 5 %.

2.5.7* Transmission idle noise

2.5.7.1 Definition

The transmission idle noise is the psophometrically weighted noise r.m.s. amplitude in dBV at the output of an ideal base station calibrated so that the r.m.s. amplitude of the reference tone is 1 Volt.

2.5.7.2 Method of measurement

The measuring set-up in Fig. 2.10 shall be calibrated so that the r.m.s. voltage of the reference tone is 1 Volt at Point 1. The psophometrically weighted idle noise r.m.s. amplitude at Point 1 of the measuring set-up shall be measured.

Note: In order to avoid interference from ambient noise, it may be necessary to enclose the handset in an acoustically insulated enclosure.

2.5.7.3 Requirements

The psophometrically weighted idle noise r.m.s. amplitude shall not exceed -60 dBV.

2.5.8 Noise cancelling device

This clause applies only to mobile stations equipped with a noise cancelling device having a high gain state for higher sound pressure levels (speech) and a low gain state for lower sound pressure levels (noise in the absence of speech).

2.5.8.1 Definition

The input/output characteristic is the amplitude of the signal at the output of an ideal base station as a function of the acoustic sound pressure level applied to the microphone.

2.5.8.2 Method of measurement

An acoustic test tone with a frequency of 1000 Hz shall be applied to the microphone. Its level shall be adjusted so that a peak frequency deviation of the RF-carrier of ± 3 kHz is obtained. The ratio D_0 between the output amplitude at Point 1 of the measuring set-up in Fig. 2.10 and the amplitude of the input signal to the artificial mouth shall be measured. The sound pressure level shall subsequently be varied as follows:

range 1 from 40 dB below the initial level to 20 dB below the initial level.

range 2 from 20 dB below the initial level to 3 dB above the initial level.

The ratio D , defined in the same manner as D_0 above, shall be recorded as a function of input level.

2.5.8.3 Requirements

The difference $D - D_0$ within range 1 shall fall between +1,0 dB and -15,0 dB.

The difference $D - D_0$ within range 2 shall fall between +1,0 dB and -1,0 dB.

2.5.9 Separate microphone

The sensitivity of an optional separate microphone shall be determined by the manufacturer. It is recommended that the sensitivity is set so that the mean modulation level, when using the separate microphone according to the manufacturers directions for use, is equal to that obtained when using the handset. The user shall have no access to any sensitivity adjustment.

2.6 VOICE PROCESSING REQUIREMENTS, RECEIVING

The CCITT Recommendations of the P-series referred to in section 2.6 are those in CCITT Blue Book, Vol. V, IXth Plenary Assembly, Melbourne, 14-25 November 1988.

For the measurements described in this section, the antenna terminal of the mobile station shall be connected, by means of a suitable coupler, to an ideal base station represented by a measuring set-up consisting of three parts (Fig. 2.12).

1. The compressor part of a 2:1 syllabic compander with a nominal attack time of 3,0 msec and a nominal recovery time of 13,5 msec. The compander shall meet the requirements in CCITT Rec. G.162. However, the compander parameters shall be calibrated to an accuracy in line with laboratory instruments.
2. A 6 dB/octave pre-emphasis network.
3. A linear modulator/radio frequency signal generator providing a frequency modulated radio frequency signal with a peak frequency deviation proportional to its input amplitude. The RF-level at the antenna input terminal of the mobile station shall be 60 dB (μ V) E.M.F.

Note: The compressor stage of the ideal base station used for type approval by the Nordic Administrations will be based on the circuit NE 570.

In this section the term "reference tone" shall mean a tone, transmitted through the system, with a frequency of 1000 Hz and producing a peak frequency deviation of ± 3 kHz. The term "reference level" shall, at any point, mean the level of the test tone at that point.

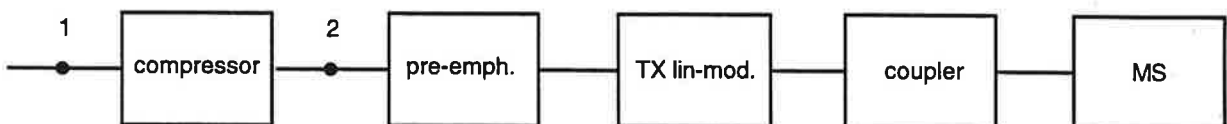

Fig. 2.12 Measuring set-up, receiving

When measuring the mobile station with deactivated compander, the compressor circuit in point 1 above is bypassed.

The paragraphs below that do not apply when the compander is deactivated, are marked with (*).

2.6.1* Expansion linearity

2.6.1.1 Definition

The expansion linearity is the deviation from the linear relation between the input amplitude of an ideal base station and the output amplitude of the expander of the mobile station.

2.6.1.2 Method of measurement

A test signal with a frequency of 1000 Hz shall be applied to point 1 of the measuring set-up in Fig. 2.12. Its amplitude shall be adjusted to the reference level. The ratio D_0 in dB between the amplitude of the input test signal and the amplitude of the signal at the output of the expander stage of the mobile station shall be measured. The input level shall subsequently be varied from +3 dB to -50 dB relative to its initial value. The ratio D between the input amplitude and the output amplitude shall be recorded as a function of input amplitude.

Note: The expansion ratio of the expander of the mobile station is 1:2. This expansion ratio is compensated by the compression ratio of 2:1 of the compressor of the measuring set-up.

2.6.1.3 Requirements

The maximum difference between D and D_0 shall be $\pm 1,0$ dB.

2.6.2* Transient response of the expander

2.6.2.1 Definition

The definition of transient response shall be as in CCITT Rec. G.162, clause 7.

2.6.2.2. Method of measurement

The transient response of the expander shall be measured with a 12 dB step of a test tone of 2000 Hz applied to Point 1 of the measuring set-up in Fig. 2.12. The high and low level of the signal shall be respectively -22 dB and -34 dB relative to the reference level.

The envelope of the signal at the output of the expander stage of the mobile station shall be recorded for an upward step.

The procedure shall be repeated for a downward step.

Note: The high and low level recommended in CCITT Rec. G.162, clause 7 are respectively -4 dB and -16 dB relative to the reference level. The values in this specification are chosen in order to avoid possible peak limiting in the radio path.

2.6.2.3 Requirements

The overshoot (positive or negative) shall in both of the above cases be less than 20 % of the final value.

2.6.3 Receive frequency response

2.6.3.1 Definition

The receive frequency response is the ratio in dB, as a function of test tone frequency, between the nominal sound pressure of the earpiece and the voltage of the test tone at the input to an ideal base station. By nominal sound pressure of the earpiece shall be meant the sound pressure in an acoustic coupler when the earpiece is placed on the coupler.

2.6.3.2 Method of measurement

The measuring set-up shown in Fig. 2.12 shall be calibrated so that the r.m.s. voltage of the reference tone is 1 Volt at Point 1 (at point 2 with deactivated compander in MS). The receive volume control of the mobile station shall be in its nominal position. The handset earpiece shall be placed tightly on an acoustic coupler complying with CCITT Rec. P.51, Section 1, Type 1. A test tone with an r.m.s. voltage of 0,1 Volt (0.3 V with deactivated compander in MS) shall be applied to Point 1 of the measuring set-up. The sound pressure level in the acoustic coupler shall be measured as a function of test tone frequency in the frequency range from 150 Hz to 7000 Hz.

Note: The procedure above may be performed as a sweep frequency measurement.

2.6.3.3 Requirements

The receive frequency response shall fall within the mask shown in Fig. 2.13.

However, the acoustic-to-electric response may exceed the mask boundaries by up to 3 dB in maximum of three arbitrary nonadjacent frequency intervals, each having a width of maximum one third of one octave.

Note: The mask may be transposed in the vertical direction.

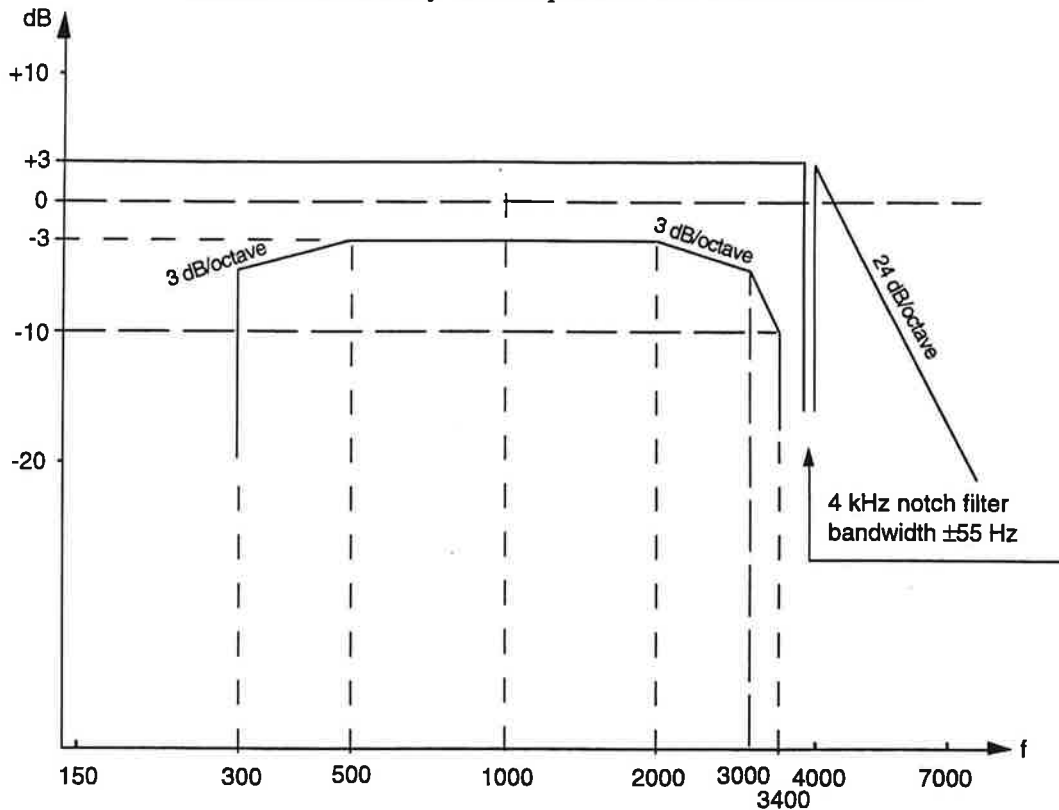

Fig. 2.13 Receive frequency response

2.6.4 Receive loudness rating

2.6.4.1 Definition

The receive loudness rating is as defined in CCITT Rec. P.79, from the electric input of an ideal base station to the acoustic output of the handset earpiece, when the base station is calibrated so that the reference level at the input to the ideal base station is 1 Volt.

2.6.4.2 Calculation method

The receive loudness rating shall be calculated from the receive frequency response function (Point 2.6.3) in the following manner: Let i denote the $1/3$ octave frequency number defined in the table below. Let S_{ri} denote the receive frequency response value in dB Pa/V for frequency number i . (See paragraph 2.6.3.2).

Calculate the receive loudness rating (RLR) from the following equation:

$$\text{RLR} = -57,1 \log_{10} \sum_{i=1}^{14} 10^{0,0175(S_{ri} - W_{ri})}$$

where the values for W_{ri} are given in the table below.

Freq. no. (i)	Freq. Hz	Receive W_{ri}
1	200	93,4
2	250	79,6
3	315	80,0
4	400	63,0
5	500	71,3
6	630	66,5
7	800	64,8
8	1000	66,4
9	1250	73,9
10	1600	70,3
11	2000	85,0
12	2500	83,9
13	3150	100,0
14	4000	122,6

Note: In CCITT Rec. P.79 a bandwidth of 100 to 8000 Hz is used for calculation loudness rating. In these specifications a bandwidth of 200 to 4000 Hz is used.

2.6.4.3 Requirements

The receive loudness rating RLR shall be 9,0 dB \pm 2 dB whether the compander in MS is active or not.

2.6.5 Receive volume control

The mobile station shall be equipped with a manual volume control, accessible to the user. In its maximum setting the increase in sensitivity relative to nominal shall be between 8 dB and 20 dB. In its minimum setting the decrease in sensitivity relative to nominal shall not be more than 12 dB.

If the volume control is of the electronic type, it is recommended that it is reset automatically to its nominal position at the termination of a call.

2.6.6 Receive harmonic distortion

2.6.6.1 Definition

The receive harmonic distortion is defined as the ratio, expressed as a percentage, of the r.m.s. amplitude of all the harmonic components of the fundamental audio frequency to the total r.m.s. amplitude of the acoustic signal of the handset earpiece.

2.6.6.2 Method of measurement

The handset earpiece shall be placed tightly on an acoustic coupler complying with CCITT Rec. P.51, Section 1, Type 1. The RF-carrier shall be modulated with a 1000 Hz tone to a peak frequency deviation of $\pm 3,5$ kHz. The manual volume control shall be set to a position so that a sound pressure of minimum 10 dBPa is obtained, or to its maximum position. The harmonic distortion of the acoustic signal in the coupler shall be measured. Without reducing the setting of the volume control, the harmonic distortion shall subsequently be measured for an RF-carrier modulated with a tone of 500 Hz to a peak frequency deviation of ± 3 kHz, and for an RF-carrier modulated with a tone of 300 Hz to a peak frequency deviation of $\pm 1,5$ kHz.

2.6.6.3 Requirements

The harmonic distortion shall not exceed 5 %.

2.6.7* Receive idle noise

2.6.7.1 Definition

The receive idle noise is the nominal A-weighted sound pressure of the handset earpiece when the mobile station is connected to an ideal base station emitting an unmodulated RF-carrier.

2.6.7.2 Method of measurement

The mobile station shall be connected to the measuring set up in Fig. 2.12. The RF-carrier shall be unmodulated. The handset earpiece shall be placed tightly on an acoustic coupler complying with CCITT Rec. P.51, Section 1, Type 1. The volume control of the handset shall be in its nominal position. The A-weighted (IEC Standard 651) sound pressure level in the acoustic coupler shall be measured.

2.6.7.3 Requirements

The A-weighted sound pressure level shall not exceed -55 dBPa.

2.6.8 Maximum sound level of handset earpiece

To protect the user from ear damage, the maximum sound level from the handset earpiece, measured in an acoustic coupler complying with CCITT Rec. P.51, Section 1, Type 1, shall not exceed 26 dBPa r.m.s. This requirement shall be valid for any operating condition, any setting of controls, and any combination of modulating frequencies and modulation indexes.

2.6.9 Volume control in "Hands-Free" mode

If a loudspeaker for "Hands-Free" operation or monitoring purposes is provided, a volume control should be provided. With the mobile station in the "Hands-Free" mode, it shall not be possible to close the receiver audio path, i.e. the minimum setting of the volume control shall still permit the user to notice when speech (of a normal level) is present.

3 OPERATIONAL CONTROLS UNIT (OCU)

The Operational Controls Unit is the interface between the user and the NMT-system. This functional unit includes a handset, "Hands-Free" facilities, mobile station controls, indicators, push-button set, dialled digits display, and tone signals with which the user interacts.

3.1 MOBILE TELEPHONE IDENTIFICATION NUMBER

The mobile station is identified by a *telephone number* composed of maximum 15 digits according to CCITT's number plan E164. The last 6 digits are in the following defined as A₁...A₆.

On the radio path, the mobile station is completely defined by the subscriber identity ZX₁...X₆ and K₁K₂K₃, where Z is used to designate the country, X₁...X₆ is an identification of the mobile station within the country and K₁K₂K₃ is used in certain signalling sequences as a password.

Programming of the *radio path identification* ZX₁...X₆K₁K₂K₃ into a mobile station shall only be possible with the special programming tools designed by the manufacturer. The programming procedures shall only be known to people authorized to operate the programming tools, see also Annex 19.

The telephone number shall be seen as dynamic and can at any time be changed by the network operator. The composition of the number is subject to national (local) variations, but normally the A₁...A₆ of the telephone number is equal to the X₁...X₆ of the radio path identification. In some special applications there is no relation between the telephone number and the radio path identification.

The mobile station shall be provided with a facility which shows the assigned *telephone number* (up to 15 digits). The shown number shall be easy to change.

It shall also be possible, without special programming tools, to read out the programmed Z and X₁...X₆ of the radio path identification.

Note: K₁ = 9 identifies an NMT 450 MS incorporating NMT SIS.

3.1.1 Secret authentication key

To protect against illicit use of a mobile telephone identification number, an authentication procedure takes place on all mobile originated calls. During this procedure, a Secret Authentication Key (SAK), a number of thirty hex digits, is used.

Since the security of the MS identity number only depends on the secrecy of the SAK, some strict requirements on the storage of the SAK must be fulfilled:

- It shall be impossible to read out the SAK after programming it once. Therefore, the authentication algorithm and the SAK shall be implemented on one chip, the security module, where a SIS-related calculations shall take place. This module shall accept RAND as an input signal, and calculate SRES and B-key based on the implemented SAK.
- The SAK shall be programmed either at the MS manufacturers premises or the security module manufacturers premises during the production process.
- The security module shall be supplied by the manufacturer as a part of the MS purchase process.
- If the security module is designed to be removable, it shall be impossible to store the mobile subscriber number on a non-volatile memory part of the security module.
- Each security module shall be identified by a unique and non-SAK related serial number. It shall be possible to read out the serial number of the actual security module in use in a simple way, e.g. via the MS display.
- One common test SAK shall be available in all security modules. Selection of a MS test mode to select this test SAK shall, for service purposes, be possible. The value of the test SAK shall be set to:

$$\begin{aligned} \text{TESTSAK} &= (\text{K1/K2/K3/K4/K5/K6}), \\ \text{with K1} &= 2^{15} + 1 = (8001)_{\text{hex}} \\ \text{K2} &= 2^{31} + 1 = (80000001)_{\text{hex}} \\ \text{K3} &= 2^{47} + 1 = (800000000001)_{\text{hex}} \\ \text{K4} = \text{K5} = \text{K6} &= 0 = (0)_{\text{hex}} \end{aligned}$$

- After power-off the MS shall return to using the original SAK, i.e. the test SAK (testmode) have to be selected after each individual power-on.

3.1.1.1 The generation and programming of SAKs

The manufacturers shall generate the SAK using a random generator (see annex 16). The total length of the SAK is 120 bits. The SAKs are programmed in MSs.

3.1.1.1.1 General requirements

1. Generating and programming SAKs shall only be possible with special programming tools designed by the manufacturers and approved by the administrations. The programming procedures shall only be known to people authorized to operate the programming tools.
2. Generating SAKs, programming SAKs and enciphering SAKs shall be done in a consecutive order without unnecessary delay.

3.1.1.1.2 Generation of the SAK

The SAK is divided into six parts

$SAK = (K1/K2/K3/K4/K5/K6)$.

The following requirements shall be fulfilled.

1. The length of K1 is 16 bits.
2. The length of K2 is 32 bits.
3. The length of K3 is 48 bits.
4. The length of K4, K5 and K6 is 8 bits each.
5. The first bit i.e. the most significant bit of K1, K2 and K3 is set to 1.
6. The SAK should be generated by a random generator according to annex 16.
7. K1 should contain at least 2 zeros and at least 2 ones.
8. K2 should contain at least 4 zeros and at least 4 ones.
9. K3 should contain at least 6 zeros and at least 6 ones.
10. The value of K3 should not be divisible by any prime less than 5000.

3.2 "ON/OFF" SWITCH (OPTION)

An "ON/OFF" switch shall be provided to switch the power "on" or "off".

3.3 HANDSET

MANDATORY:

If a handset is provided, all relevant acoustical requirements shall apply.

OPTION:

A handset is optional.

3.4 "HANDS-FREE" OPERATION (OPTION)

Operation of the mobile station in "Handset" mode as well as in "Hands-Free" mode shall be possible. For this purpose the mobile equipment shall permit simultaneous connection of the handset as well as a fixed mounted microphone with an associated loudspeaker. A separate "Push-to-talk" button for manual speech-path switching is optional.

A mobile station may be equipped with a loudspeaker just for monitoring the signal path MTX-MS (listening) in "Hands-Free" mode.

The handset earpiece may be used as a monitoring loudspeaker

- a) when the handset is mechanically cradled and
- b) the monitoring volume is automatically reduced to normal volume when the handset is uncradled.

If a loudspeaker is not connected, the MS shall not be able to enter "Hands-Free" mode.

3.5 DELETED

3.6 DIALLING FACILITIES

3.6.1 Push-button set (OPTION)

A 12-button set shall be provided:

- 10 digit buttons (1,2,3,4,5,6,7,8,9 and 0)
- and buttons for * and #

The push-button set shall be available for use in "on-hook" condition as well as during conversation.

3.6.2 Dialed digits memory (DDM)

MANDATORY:

The MS shall be able to store at least 23 digits in the DDM.

OPTION:

A dialed digits display shall be provided (see paragraph 3.9.5).

If the number of digits selected by the push button set exceeds the storage capacity of the dialed digits memory, the last selected digits shall be stored in the memory (first in-first out).

The DDM and dialed digits display shall be cleared when:

- the user has applied a "cancellation procedure"
- the MS goes "on hook"
- the content has been sent to MTX or address complete is received from MTX

In the conversation state digits selected on the push-button set may be stored in the DDM (and display). The information shall be stored in abbreviated number store position 00 and the DDM (and display) cleared when the conversation is terminated.

The information is retrieved (recalled into DDM and displayed) by selecting the abbreviated number 00 #.

3.7 ACOUSTIC SIGNALS GENERATED BY THE MOBILE STATION (OPTION)

3.7.1 General

At least two types of acoustical alarms shall be provided as described below. However they may be suppressed by means of user action. All other acoustical signals shall be distinguished audibly from these.

3.7.2 Ringing signal

An acoustic ringing signal having a duration of approximately 1 sec shall be provided to inform the user of an incoming call (MTX-MS). The sound level may be adjustable.

The ringing signal shall be generated locally in the mobile station and be activated when receiving frame 5a (L=9) in signalling scheme MTX-MS.

3.7.3 Malfunction alarm

The malfunction alarm shall be clearly distinguished from the ringing signal.

The malfunction alarm shall be activated due to:

- a) - unsuccessful call attempt
- b) - MTX forced release or clearing.
- c) - the user initiating "off-hook" when the MS is in signalling scheme D (roaming information), according to the state tables, see paragraph 5.3.

As an option the malfunction alarm may, in the following special cases in "power on" condition, be activated when the mobile station is "on hook" to alert the user:

- d) - When the roaming alarm is activated.
- e) - When the voltage supplied to the mobile station drops below a certain value.
- f) - In conversation state, a short period before the MS turns off due to low battery voltage.

3.8 COUNTRY SELECTOR

MANDATORY:

Automatic country selection is not allowed. The assigned Y₁-values are mandatory for the countries that are included in a country selector.

"FI or FINLAND" is mandatory as indicators for FINLAND (From 1/1 1994) as soon as a country indicator is implemented.

OPTION:

A country selector, which determines a group of traffic areas (corresponding to the mobile telephone network of one country) where the mobile station communicates, shall be provided. The traffic area groups are characterized by Y₁ in the traffic area number Y₁Y₂. A mobile station without country selector can not roam to another country.

Y₁ are reserved for assignment to countries. The same value of Y₁ can be assigned to more than one country. The mobile subscriber selects country manually when travelling from one country to another.

The number of country indications shall be at least eight. The selected country shall be indicated to the user by letters in a clearly visible way. In case the selected country is indicated on the dialled digits display, (DDD, see paragraph 3.9.5), the country indication shall be shown unless specified information regarding dialled digits memory, register recall function and MFT function is shown on DDD.

The information about the selected country shall be memorized for at least one week when the MS is in "power off" condition. See also paragraph 5.2.1.1

The Y₁ assignments to the countries below are shown in the following table.

Table of used Y₁ values

Country / Region	Operator assigned	Value of Y ₁	Recommended indication /(ISO)
Denmark	Tele Danmark Mobile	5	DK
Sweden	Telia Mobitel	6	S or SE
Norway	Telenor Mobil	7	N or NO
Finland	Telecom Finland	8	FI
Iceland	Post & Telecom	8	IS
Faroe Islands	Faroese Telecom	5	FO
Estonia	Eesti Mobiiltelfon	7	EE
Latvia	Latvian Mobile Telephone	5	LV
Lithuania	COMLIET	8	LT
Belarus	Belcel	6	BY
OSS/Moscow	Moscow Cellular Comm.	5	MO
OSS/St Petersburg	Delta Telecom	6	STP
OSS/Leningrads Dist.	Delta Telecom	6	STP
OSS/Carelian Rep.	Telecom Finland	7	CAR
OSS/Murmansk	Telecom Finland	5	MUR
OSS/Leningrads Dist.	Telecom Finland	5	LED
Kaliningrad	Telecom Finland	5	KAL
Poland	CENTERTEL	7	PL
Bulgaria	MOBIFON	6	BG
Romania	Telefonica Romania	5	RO
Ukraine	Ukraine Mobile Comm.	8	UA
		1	RU1
		2	RU2
		3	RU3
		4	RU4

The indication to the user is a recommendation except "FI or Finland".

The table is under constant revision. The latest version can be retrieved from the operators.

Y₁=0000 is recommended for systems with no roaming with the existing 450 countries.

3.9 VISUAL INDICATORS

General

The selection of colour and/or position of other indications to the user shall be such that the mandatory indicators can be clearly distinguished from the Dialed Digits Display and optional indicators.

It shall be possible to display the status of all mandatory indicators simultaneously.

The state "power on" shall be visually indicated to the user

3.9.2 Service indicator

The service indicator shall be shown to the user as long as the MS is locked to a calling channel. If the indication is coloured it shall be green.

Recommended symbol is  (circle).

3.9.3 Call received indicator (OPTION)

The call received indicator shall be flashing periodically when activated. It shall be constantly shown to the user, starting when the MS is in the state "wait for next ringing order" until the user invokes off-hook .

Recommended symbol is  (square).

3.9.4 Roaming alarm indicator

The roaming alarm indicator shall be shown to the user as long as the MS is in roaming alarm state i.e. the automatic updating procedure has failed. If the indication is coloured it shall be red.

Recommended symbol is  (triangle).

3.9.5 Dialed digits display (DDD) (OPTION)

A dialed digits display shall be provided. The number of displayed digits shall be minimum 8. The display shall be able to show the decimal digits 0-9, * and #.

The content of the display shall be in accordance with the content of the dialled digits memory (except in the state dialled digits memory empty). If the display has fewer positions than the dialled digits memory, the least significant part (last selected digits) shall be shown on the display. Furthermore, when the dialled digits memory is in the empty state, and the dialled digits display is not used for register recall function (see Annex 8) or MFT function (see Annex 6), the dialled digits display may be used for showing other information to the user, e.g. about MS facilities. This other information shall not be transferred to the dialled digits memory.

3.9.6 Off hook indicator

The "off hook indicator" informs the user that the MS is in off hook state. The indication shall be clearly distinguished from other indicators.

3.9.7 Selected country indicator (OPTION)

See paragraph 3.8

The country indicator shall be visible after power on. It may be suppressed by user action.

3.10 SUPPLEMENTARY FACILITIES (OPTION)

3.10.1 Shift Mode

1. The functions of the push-button set in paragraph 3.6.1 may be temporarily changed by one or several "shift-modes"

The "shift modes" shall not change the meaning of the On-Hook/Off-Hook operations or the power on/off functions.

2. The meaning of the push button set shall revert to normal 10s after the last button pushed. If the selected shift function by its nature requires more than 10s, e.g. voice-mail retrieval, the 10s timer shall start after the termination of the function.

3. Any function invoked by "shift mode" and subsequent key operation, may remain active after the 10s period providing they do not interfere with any mandatory function.

3.10.2 Immediate call transfer indication

The MS may have an indicator or indication to show that an immediate Call Transfer service is activated in the MTX. Recommended symbol is -> (arrow).

The indicator is controlled by the clearing signal received from the MTX. See NMT Doc 450-1.

3.10.3 Transmission of MFT signalling from MS

Transmission of MFT signalling may be possible via the push button set in the MS. In this case, the 1200 baud FFSK signalling from MS is converted to MFT signalling by means of an MFT converter in the MTX. (See Annex 6.)

3.10.4 Locking facility requirements

The MS may be equipped with a mechanical or electronic locking facility to prevent undesired use. However, when the MS is in Power On state, emergency calls to the international emergency number 112 and national emergency numbers must be possible.

4 OPERATIONAL PROCEDURES

The operational procedures concerning initiation and termination of calls can be done in different ways, depending on the facilities of the MS. The specifications for the different types are listed below.

4.1 GENERAL REQUIREMENTS

MANDATORY:

A: The user shall always have a one-step access to the on-hook function.

OPTION:

B: The user shall always have a one-key access to the off-hook function

C: Going into and out of Hands-Free mode shall be possible from either On Hook state or Off-Hook state.

Some additional procedures are described in the following paragraphs.

4.2 MANUAL ROAMING UPDATING

4.2.1 Updating by initiating "off-hook"

State: Power "on", "on-hook", roaming alarm, DDM empty.

<u>User action</u>	<u>MS-response</u>
Initiate "off-hook"	Service indicator "off" (if activated). Off hook indicator "on". Roaming alarm turned "off" (when roaming updating confirmation is received from MTX)
	Malfunction alarm (may be delayed maximum 5 seconds)
Initiate "on-hook"	MS back to standby. off hook indicator "off"

4.2.2 Updating by generating a call

State: Power "on", "on-hook", roaming alarm, digits in DDM.

<u>User action</u>	<u>MS response</u>
--------------------	--------------------

Initiate "off-hook" to generate a call	
--	--

	Service indicator "off" (if activated). Off hook indicator "on". Roaming alarm turned "off" (when roaming updating confirmation/proceed to send is received from MTX)
--	---

(Conversation)

4.3 ABBREVIATED DIALLING (OPTION)

The MS shall have an abbreviated number store with a minimum storage capacity of fifty 23-digit telephone numbers.

The push-button set in the MS shall be used for programming, cancellation, and check of the content of the abbreviated number store. The following procedures shall be used:

State: power "on", "on-hook" or conversation state

<u>User action</u>	<u>MS-response</u>
--------------------	--------------------

Programming

Dial $*X_1X_2*S_1...S_n\#$	Digits stored in dialled digits memory
----------------------------	--

*	The telephone number $S_1S_2...S_n$ is stored in the abbreviated number store. Dialled digits memory is cleared.
---	--

Cancellation

Dial $\#X_1X_2\#$	Digits stored in dialled digits memory
-------------------	--

*	Cancellation of this abbreviated number is done in the abbreviated number store. Dialled digits memory is cleared.
---	--

Check

Dial X_1X_2	Digits X_1X_2 are shown on the display
---------------	--

#	The corresponding telephone number is shown on the display. The last digits are displayed if the telephone number is longer than the display capacity.
---	--

# or ##	The display is cleared
---------	------------------------

Activation of the abbreviated number store

Dial the abbreviated number X_1X_2	Digits X_1X_2 are stored in dialled digits memory.
#	The actual telephone number corresponding to the abbreviated number is stored in dialled digits memory.
Initiate "Off-Hook"	Service indicator "off". Off hook indicator "on". MS searches for a free traffic channel. When found, digits are transmitted to MTX.
	(Answer)

(Conversation)

Note: X_1X_2 (or X_1 only) is the abbreviated number, and $S_1S_2\dots S_n$ is the corresponding telephone number.

The digit S shall accept the values 0-9, *, and #. The code #* indicates that a programming/cancellation in the abbreviated number store shall be done.

Cancellation of wrong dialled information shall be done by dialling ##.

In case the last digit S_n is # when programming the abbreviated number store, the last digit ($S_n = \#$) shall not be considered as part of the cancellation procedure ##.

4.4 DIALLED DIGITS MEMORY (DDM) (OPTION)

The dialled digits memory shall store the digits dialled by the user in "on-hook" condition or in conversation state. This includes also * and #.

The memory and dialled digits display shall be cleared when:

- the user has applied a "cancellation procedure" (##) during dialling
- MS goes "on hook"
- all the digits have been sent to the MTX or address complete is received from MTX

In case the dialled digits are $*X_1X_2*S_1S_2...S_n$ and X_1X_2 is equal to a valid abbreviated number, and S_n is #, the last digit ($S_n=#$) shall not be considered as a part of the cancellation procedure ##.

Recall of the last dialled number shall be possible by dialling the abbreviated number 0#. A repeated call attempt can then be performed by initiating "off hook".

The content of DDM shall be copied into abbreviated number store position 0 when the MS goes "off hook".

4.5 ADDITIONAL USE OF THE PUSH-BUTTON SET

MANDATORY:

If no display is provided, the NMT SIS reference number shall be easily readable from number plate, sticker or similar.

In conversation state

- the push-button set shall be blocked until all digits in DDM have been sent to MTX in the call set-up procedure and until address complete is received.

In standby state

- The MS shall be equipped with a possibility for the user to easily read the NMT SIS reference number (18 decimal digits). The NMT-SIS reference number is composed as follows:

Manufacturers number	(4 digits)
Production date	(6 digits)
Sequence number	(5 digits)
Checksum	(3 digits)

- The presentation to the user shall be in decimal form and in the sequence indicated above.

OPTION:

- the content of DDM (initiated during conversation) shall be stored in the abbreviated number store position 00 when the call is terminated (on hook)

Operational procedures Flow Chart

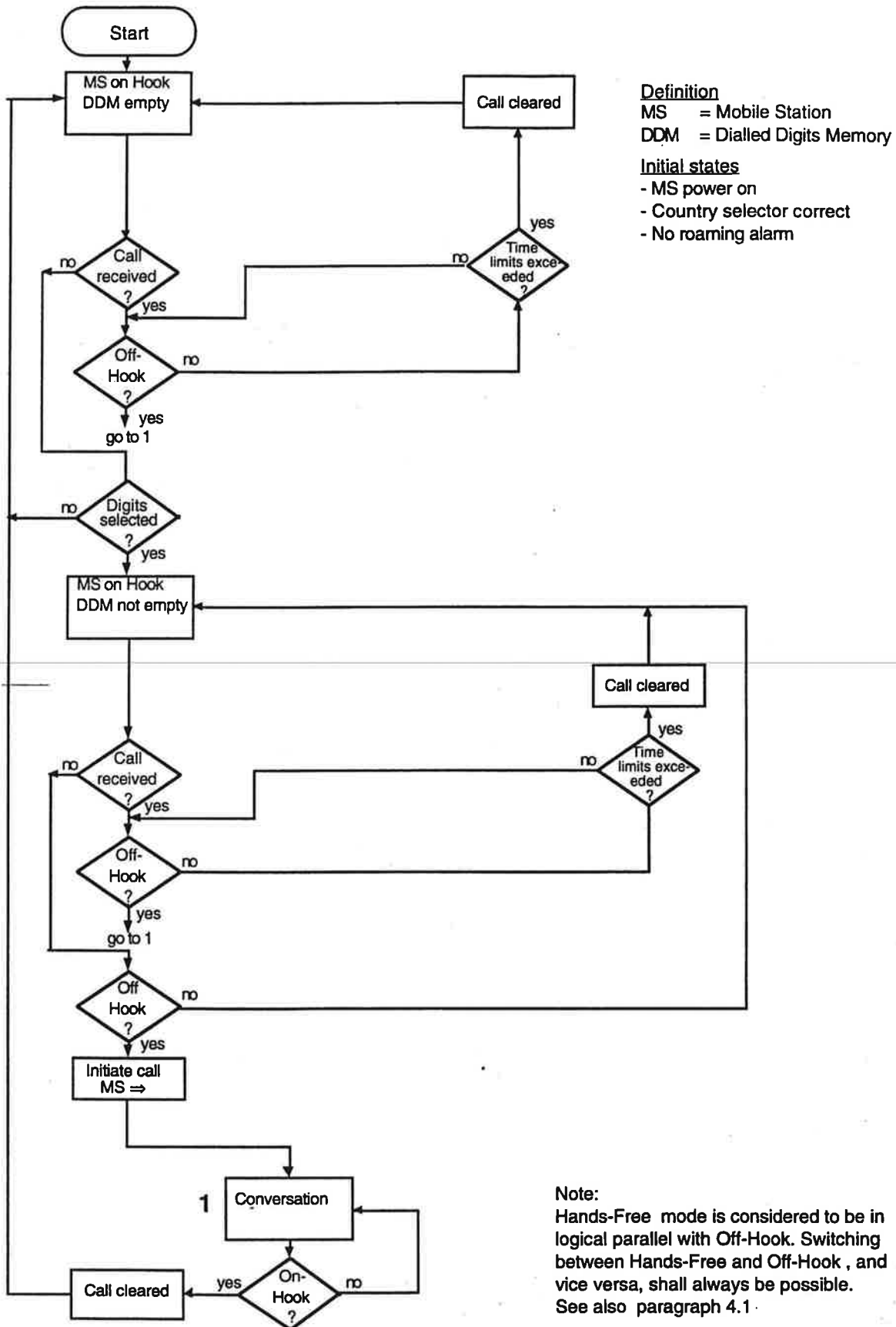

Fig 4.1

5 LOGIC AND CONTROL UNIT (LCU) AND SIGNALLING EQUIPMENT

5.1 GENERAL

The LCU functions as the master control for the MS states, supervises proper functioning and decides the appropriate actions to be taken. The main states are:

- Power off
- Standby
- Signalling
- Search for CC
- Search for TC, MS off hook
- Search for TC, roaming flag set, MS on hook
- Search for TC, no roaming flag set, MS on hook
- Conversation

The LCU communicates with and controls the following entities:

- Signalling equipment
- OCU (Operational Control Unit)
- Transceiver
- Audio Processing Circuits (APC)
- Power supply system.

Upon Input/Output signals from these entities, the LCU decides appropriate actions to be taken.

Some of the functions of the Logic and Control Unit are:

- * Decoding orders from the MTX such as:
 - alerting the user to an incoming call (ringing order)
 - channel command
 - adjusting the transceiver output power
 - identity and authentication request
 - releasing the MS at completion of a call or forced release.
 - calculation in a dedicated security chip of SRES and B-key on basis of the received RAND
 - encryption of the dialled digits based on the calculated B-key
- * Receiving general identification signals from the MTX such as:
 - traffic area identification
 - calling channel identification
 - free traffic channel identification

- * Evaluating and ordering the necessary steps to be taken by the mobile station
- * Encoding the signalling information to the MTX such as:
 - call initiation from MS (identification and authentication)
 - clearing signal when terminating a call
 - updating roaming information
 - dialled digits, encrypted or not, for call origination
- * Providing subscriber signalling information such as:
 - ringing signal
 - roaming alarm
 - malfunction alarm
 - service indicator
 - call received indicator

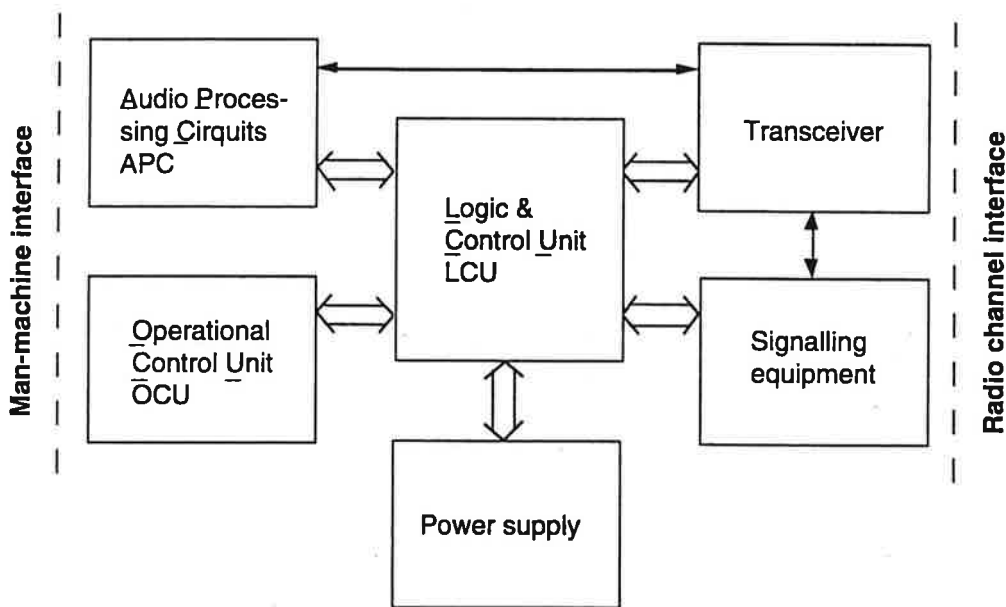

Fig. 5.1 Logic connections between the LCU and other entities in the MS

5.2 DESCRIPTION OF LCU ACTIVITIES

This paragraph describes how the LCU functions shall be carried out. The paragraph consists of:

- Description of main states
- Description of minor states in the signalling state
- Task description

5.2.1 Description of main states

The procedures to be carried out by the LCU depends on:

- In which state the MS is from the outset.
- To which state the MS is ordered by the user, timing circuits or the MTX.

Transferring the MS from one state to another is described in the signalling procedures in NMT Doc 450-1, the input/output state relations (5.3) and the explanatory flow diagrams (5.4).

The logic connections between the main states are shown in fig. 5.2.

5.2.1.1 Power off

The MS is in "OFF" state when the "ON/OFF" switch is turned "OFF" or if the voltage supplied to the MS falls below V volts (as specified by the manufacturer). In this state, no external power except for support charging of backup batteries shall be applied to the MS. In "OFF" condition, the following information shall be stored in the MS:

- the actual setting of the country selector, see paragraph 3.8.
- the traffic area number $Y_1 Y_2$ recorded and stored at the moment the MS was switched "OFF";
- the roaming alarm status information,
- preprogrammed addresses (numbers)
- SAK and MS identity number
- Immediate call transfer status (if implemented)

Also other information e.g. call received indicator state may be stored.

This information shall be maintained in the "OFF" condition for at least one week without support charging of possible back-up batteries.

Main states for LCU

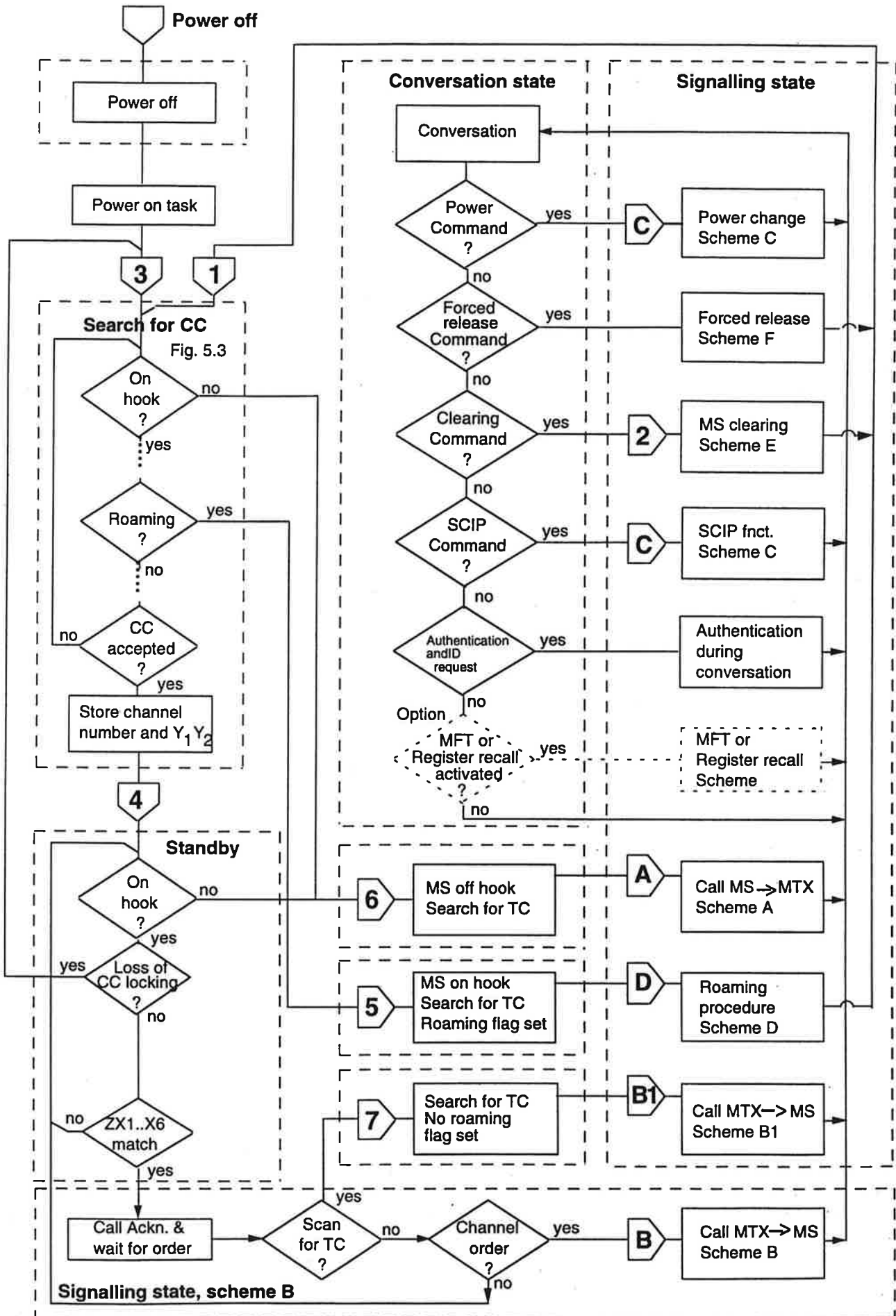

Fig. 5.2

5.2.1.2 Standby

In this state, the MS rests on a calling channel with valid traffic area number and calling channel prefix (or combined calling/traffic channel prefix) and the channel number is the same as in the RF-synthesizer. The MS is ready for reception or initiation of a call.

In the standby state the MS shall read the additional information as described in NMT Doc 450-1.

If the MS loses the lock to the calling channel it starts the procedure search for calling channel (see paragraph 5.2.1.4.)

If the MS receives its own identity in frame 2a, it leaves the procedure standby state and enters the signalling scheme B or B1 (see fig 5.2).

If the user initiates a call, the MS leaves the standby state and enters the procedure search for traffic channel (see paragraph 5.2.1.5.)

When the MS leaves the calling channel, the Logic and Control Unit shall store this channel number (previous CC).

In the standby state the service indicator is activated.

Loss of locking to a calling channel

The MS shall enter the state search for CC if:

- a) The received RF level has been less than 10 dB (μ V) E.M.F. \pm 4 dB during 75 % of the last 2 minutes (\pm 20 seconds.)
- b) The signalling frame 2a (call to actual MS) has been received twice without receiving frame 2b, 2c, 2d or 2f (channel order) during 10 seconds (\pm 1 second) after the first received 2a frame. The MS shall wait for channel order in 2T before entering the state search for CC. The 10 sec. period does not include the waiting time for frame 2b, 2c, 2d or 2f.
- c) More than two consecutive frames are lost. See NMT Doc 450-1

After loss of channel locking, the MS shall start searching from a "random" channel.

5.2.1.3 Conversation

The MS reaches the conversation state after completion of signalling schemes A, B, B1 or C. In this state, the speech path is through connected in the MS and the supervisory signal is looped back to BS. The MS shall be sensitive to channel order, power change command, authentication and ID-request and forced release from MTX.

The MS shall not be sensitive to compander in/out orders during the conversation state. The MS shall only be sensitive to these signals during the following periods:

Scheme A: In T (8 frames) after reception of address complete (first received frame 5a (L= 6))

Scheme B and B1: In T (8 frames) after transmission of MS answer (last sent frame 13a (L=14))

Scheme C: In T (8 frames) after transmission of MS identity (last sent frame 10b)

If the user terminates the call and replaces the handset, the MS closes the speech path and the supervisory signal loop, and enters the signalling state MS clearing.

If the MS receives clearing signal, the speech path and the supervisory signal loop are closed, and the MS enters the signalling state forced release.

When the MS receives channel order, it enters signalling scheme C. When the MS receives an ID and authentication request it enter signalling scheme, authentication during conversation.

The MS shall stay in the conversation state even after voltage drops to 6 V or lower for a period of at least 3 seconds, but not longer than 12 seconds, to withstand start of the engine or change of battery pack in case of HMS.

During conversation the MS may have an autonomous change of the output power. See para. 5.7.1.2.

5.2.1.4 Search for channels

In the states search for CC and TC the MS uses the following information:

- Country selector setting
- Number of complete scans performed
- Received RF level
- Stored $Y_1 Y_2$

5.2.1.4.1 Definitions

Traffic area number Y_1Y_2

Y_1Y_2 are specified in NMT Doc 450-1. Y_1 indicate traffic area group (country).

Y_2 indicates the actual traffic area.

Stored traffic area number is the number of the traffic area where the MS is updated.

The initial channel is the channel on which the MS starts scanning.

Random channel means a channel chosen in a random way within the band.

Previous channel is the last CC, CC/TC or TC to which the MS has been locked. The MS shall store the power bits and channel number received in the last frame on this channel.

Scanning is the systematical one-by-one search for an RF channel within the channel band according to the channel acceptance procedure. The scanning is divided in three parts, A, B and C, during which different RF level criterias are used.

RF level A is the part where the MS shall accept a channel with an RF level above 24 dB (μV) E.M.F. and it shall reject channels with an RF level below 16 dB (μV) E.M.F.

RF level B is the part where the MS shall accept a channel with an RF level above 14 dB (μV) E.M.F. and it shall reject channels with an RF level below 6 dB (μV) E.M.F.

RF level C is the part where the MS shall accept a channel with an RF level above 0 dB (μV) E.M.F. +2 dB (μV) E.M.F. at extreme test conditions and it shall reject channels with an RF level below -4 dB (μV) E.M.F. -6 dB (μV) E.M.F. at extreme test conditions.

A scan is one complete search through all the RF channels within the channel band. The scanning shall be done in 25 kHz steps.

"On hook" is the state where the MS is internally "on hook" independent if it is cradled or not. (Cradle switch is optional.)

Test for roaming. This state is entered, when the MS has detected a CC with a new traffic area number Y_1Y_2 .

Roaming flag set is the state where the MS searches for a free marked traffic channel in the new traffic area in order to initiate roaming updating (scheme D).

The scan counter counts every scan through the channel band.

5.2.1.4.2 Channel acceptance procedure

This section contains the requirements for accepting a calling channel (CC), a free marked traffic channel (TC), or a combined CC/TC.

The number of scans used for each RF level in the scanning procedure are given in table 5.2.1.4.2 below.

Used RF level criteria	Number of scans
RF level A	1
RF level B	3
RF level C	11

Table 5.2.1.4.2 Number of scans in the scanning procedure

When the MS detects a carrier, it shall check whether the channel is modulated with an FFSK signal or not. If no FFSK signal is detected within 20 ms the receiver goes to channel N+1. The specified 20 ms includes the channel switching time.

During the first scan the MS shall not accept combined CC/TC in search for TC.

The total number of scans for A, B and C is set to maximum 15 scans.

During search for a channel the MS shall check that there is a match between the received channel number information and the synthesizer setting after having detected RF and FFSK. Then the $Y_1 Y_2$ shall be checked. Y_1 shall match the setting of the country selector (see paragraph 3.8). Y_2 shall be checked for a match with the stored traffic area information.

The MS shall check that the relevant channel prefix is received, see NMT Doc 450-1.

If there is a mismatch in the check, the MS shall switch to next channel. All these checks shall be carried out within T''' (two frames) after switching to the channel.

5.2.1.5 Search for calling channel

This procedure is initiated e.g. after DC power start up or if the MS goes on hook.

Whenever the MS enters this procedure after leaving the signalling scheme (A, B, D and clearing), it shall start the scan on the previous calling channel.

Entering this procedure from any other state (including scheme B1), the MS shall start the scan from a random channel as initial channel. For each channel the MS shall execute the channel acceptance procedure. When a calling channel

with a stored traffic area number is found, the MS shall lock to this channel and enter *standby* state.

The MS shall accept a CC with a new traffic area number $Y_1 Y_2$ (within the same traffic area group Y_1) if:

- a. no acceptable CC with the old traffic area number is detected in two scans, and
- b. an acceptable CC with a new $Y_1 Y_2$ is detected twice.

If a new $Y_1 Y_2'$ has been accepted, the MS shall replace the stored $Y_1 Y_2$ with the new $Y_1 Y_2'$ and enter the state *roaming flag set*.

These conditions may be processed simultaneously (i.e. two complete scans may be sufficient for the decision of roaming updating).

The MS shall then search for a traffic channel in the traffic area $Y_1 Y_2'$ and initiate signalling scheme D. After completion of signalling scheme D, the MS shall return to the new calling channel. If signalling scheme D is not successfully completed, the MS shall enter the *roaming alarm state*. Also in this case the MS shall return to the new calling channel.

If a mobile subscriber initiates a call while the MS is searching for a calling channel, the MS shall leave this procedure and start searching for a traffic channel as described in paragraph 5.2.1.6

State: Search for CC

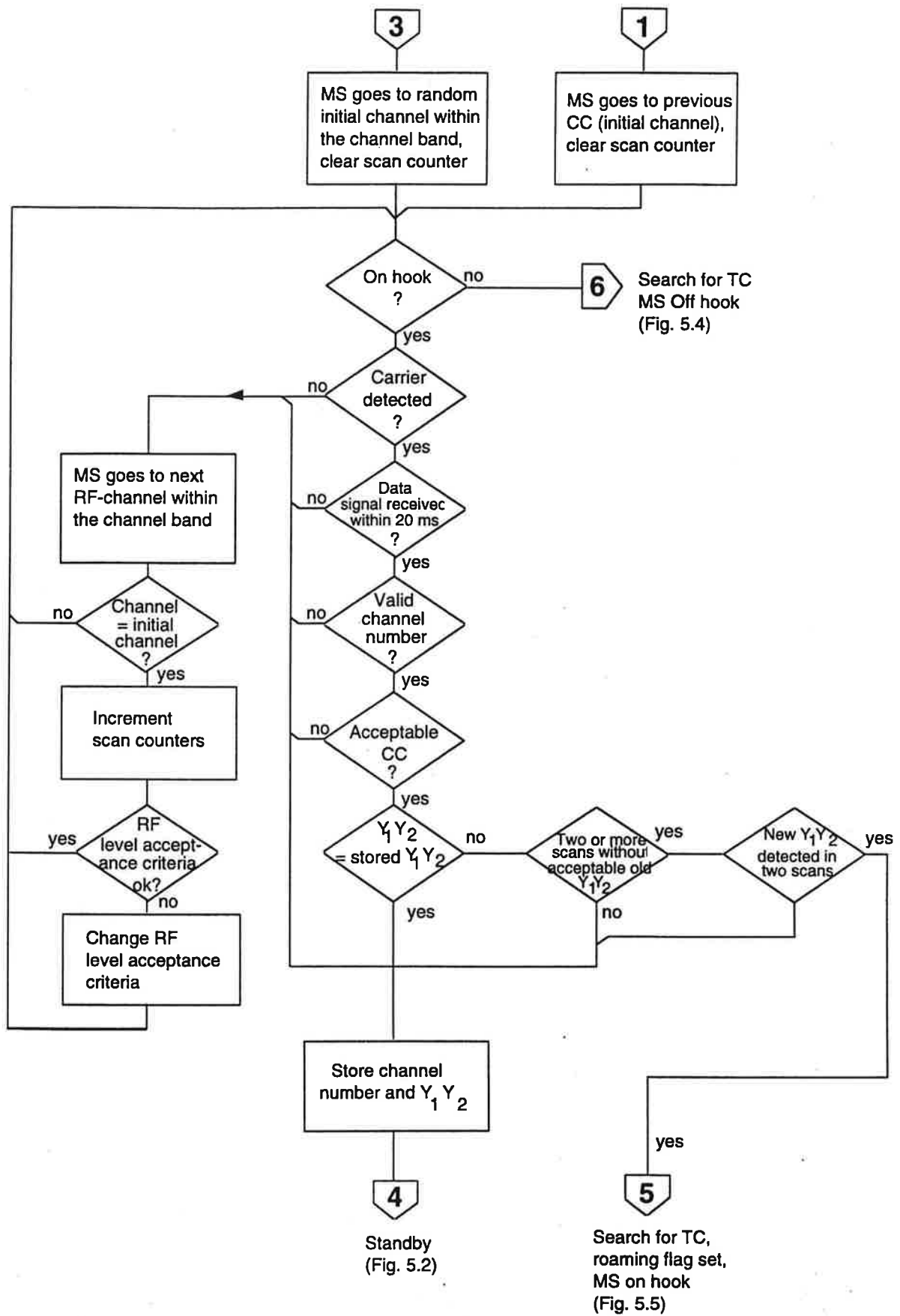

Fig. 5.3

5.2.1.6 Search for free marked traffic channel (MS off hook)

The search for free marked traffic channel shall start from a channel selected at *random*. The purpose of this procedure is to distribute the call attempts among all free marked traffic channels.

Scheme A

A necessary condition for entering scheme A is that the MS is "off hook" or the "Hands-Free" button is activated. There are three (four as an option) possibilities depending on the status information.

- No roaming flag set, no roaming alarm.

This is the normal case for an ordinary call. When the MS has locked to a free marked traffic channel, it enters scheme A.

- No roaming flag set, roaming alarm.

In this case, the MS shall accept any traffic channel which is in accordance with the country selector. After a successful completion of scheme A the MS is updated and the call is completed. The used traffic area number $Y_1 Y_2$ shall be stored as the updated traffic area.

- Roaming flag set, no roaming alarm.

This is the case where the MS goes "off hook" while searching for a free marked traffic channel as described for scheme D. When the MS has locked to a free marked TC it enters scheme A and in addition updates itself.

- No roaming flag set, no roaming alarm, no previous $Y_1 Y_2$ detected.

As an option MS may also accept a TC on a new traffic area $Y_1 Y_2$ and enter scheme A, if:

- a. No acceptable CC with the old traffic area number $Y_1 Y_2$ (stored in MS) is detected in two scans and
- b. an acceptable CC with a new $Y_1 Y_2$ is detected twice.

This requires simultaneous processing of search for CC (see paragraph 5.2.1.5) and search for TC

This optional function is not specified separately in detail in state tables (paragraph 5.3). Simultaneous processing of search for CC must be performed as in states 4.5 (without locking to the CC), 4.6 and 4.7.

After acceptance of the new $Y_1 Y_2$, search for TC on the new $Y_1 Y_2$ must be started from the beginning (as specified in paragraph 5.2.1.4). If search for TC on the new $Y_1 Y_2$ fails before completing state 15.1 (proceed to send/roaming updating confirmation received), the MS shall activate both roaming alarm indicator and malfunction alarm and return to search for CC.

If no free marked traffic channel is found during 15 scans, the MS shall go "on hook" and activate malfunction alarm.

State: Search for TC, MS OFF hook

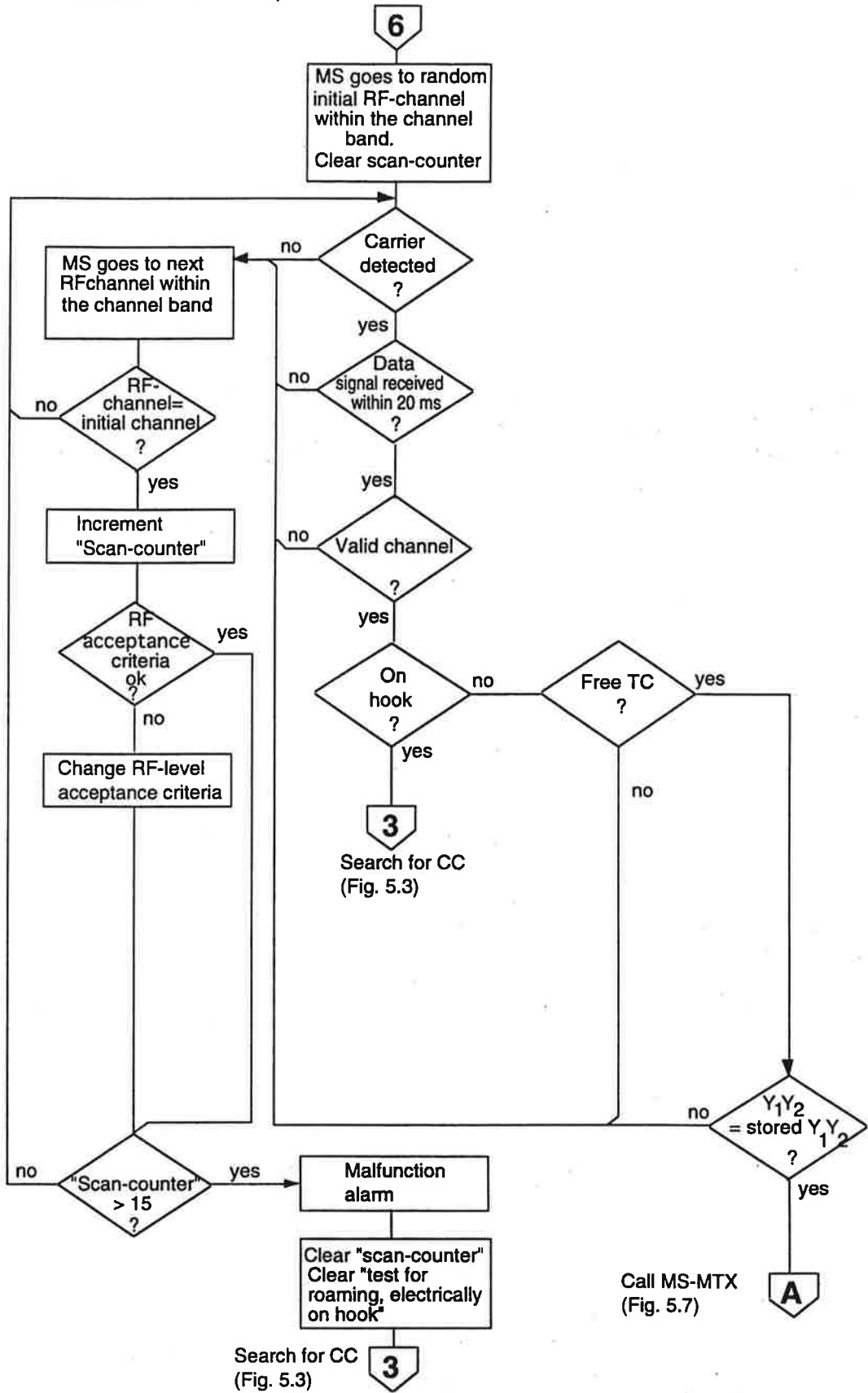

Fig. 5.4

5.2.1.7 Search for TC, roaming flag set, MS on hook

When a new Y_1Y_2' is accepted, the MS shall replace the stored Y_1Y_2 with the new Y_1Y_2' and enter the state roaming flag set.

The MS shall then search for TC with traffic area number Y_1Y_2' , see fig 5.5. After completion of the signalling scheme D, the MS shall return to the new calling channel. If the signalling scheme D is not successfully completed, the MS shall enter the *roaming alarm state*. Also in this case the MS shall return to the new calling channel.

The search for free marked traffic channel shall start from a randomly selected channel. Scheme D is initiated only when the MS is "on hook" and in the state roaming flag set, no roaming alarm.

The MS is in a state where it has the information that Y_1Y_2 has changed to Y_1Y_2' . It shall now search for TC with the traffic area marking Y_1Y_2' and enter scheme D.

If the MS does not find a free marked traffic channel within 15 scans, it clears the Y_1Y_2' and enters the search for calling channel procedure.

5.2.1.8 Search for TC, No roaming flag set, MS on hook.

If the MS has sent call acknowledgement in signalling scheme B and there are no free marked traffic channels associated to the actual CC, the MTX may order the MS to search for a free marked traffic channel on neighbouring base stations. There the MS will report and ask for the call.

The search for TC shall start from a randomly selected channel.

If no TC is found within 10 ± 1 seconds, the MS shall enter the state search for CC from a randomly selected channel.

State: Search for TC, roaming flag set, MS on hook

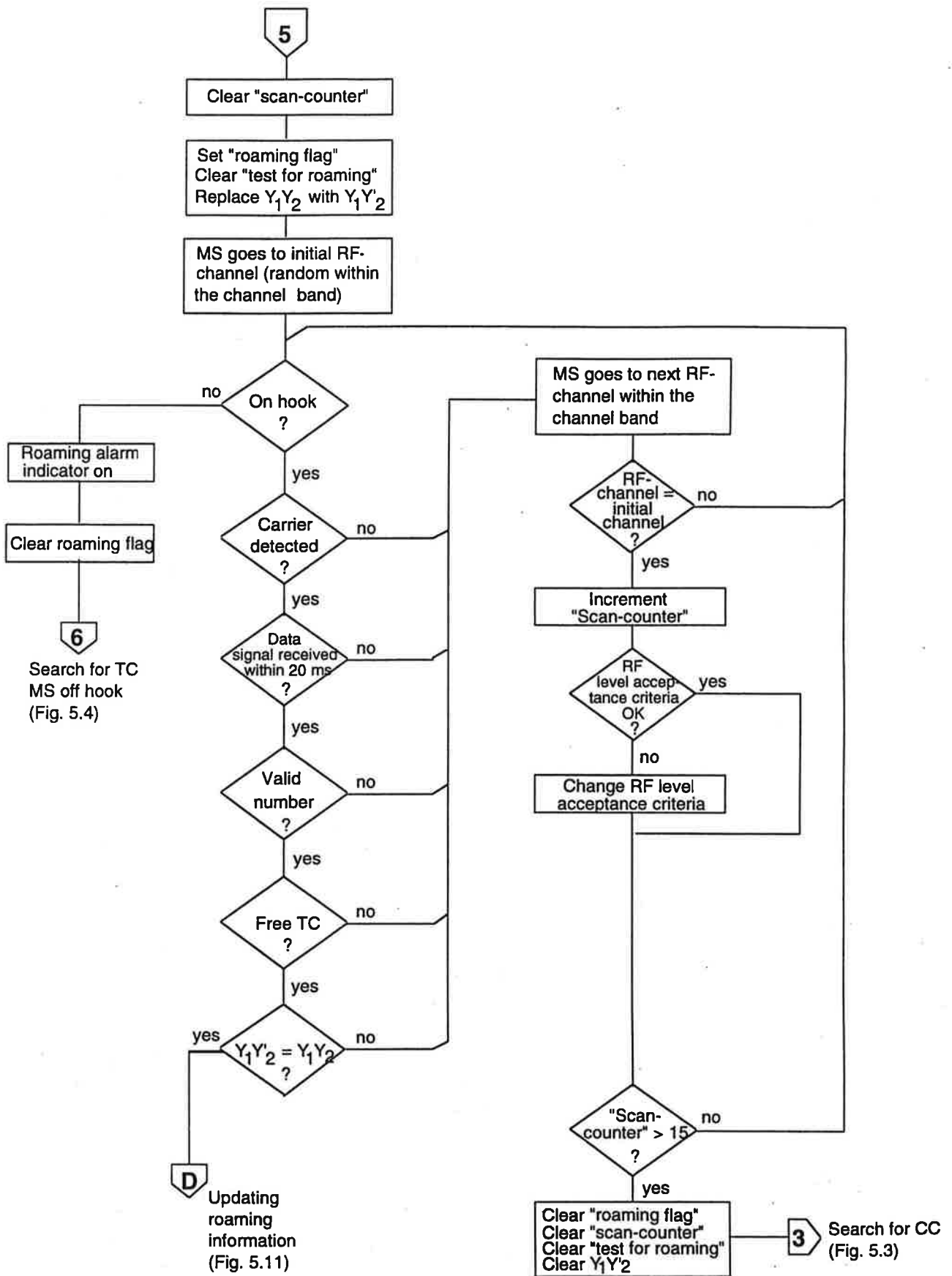

Fig 5.5

State: Search for TC, no roaming flag set, MS on hook

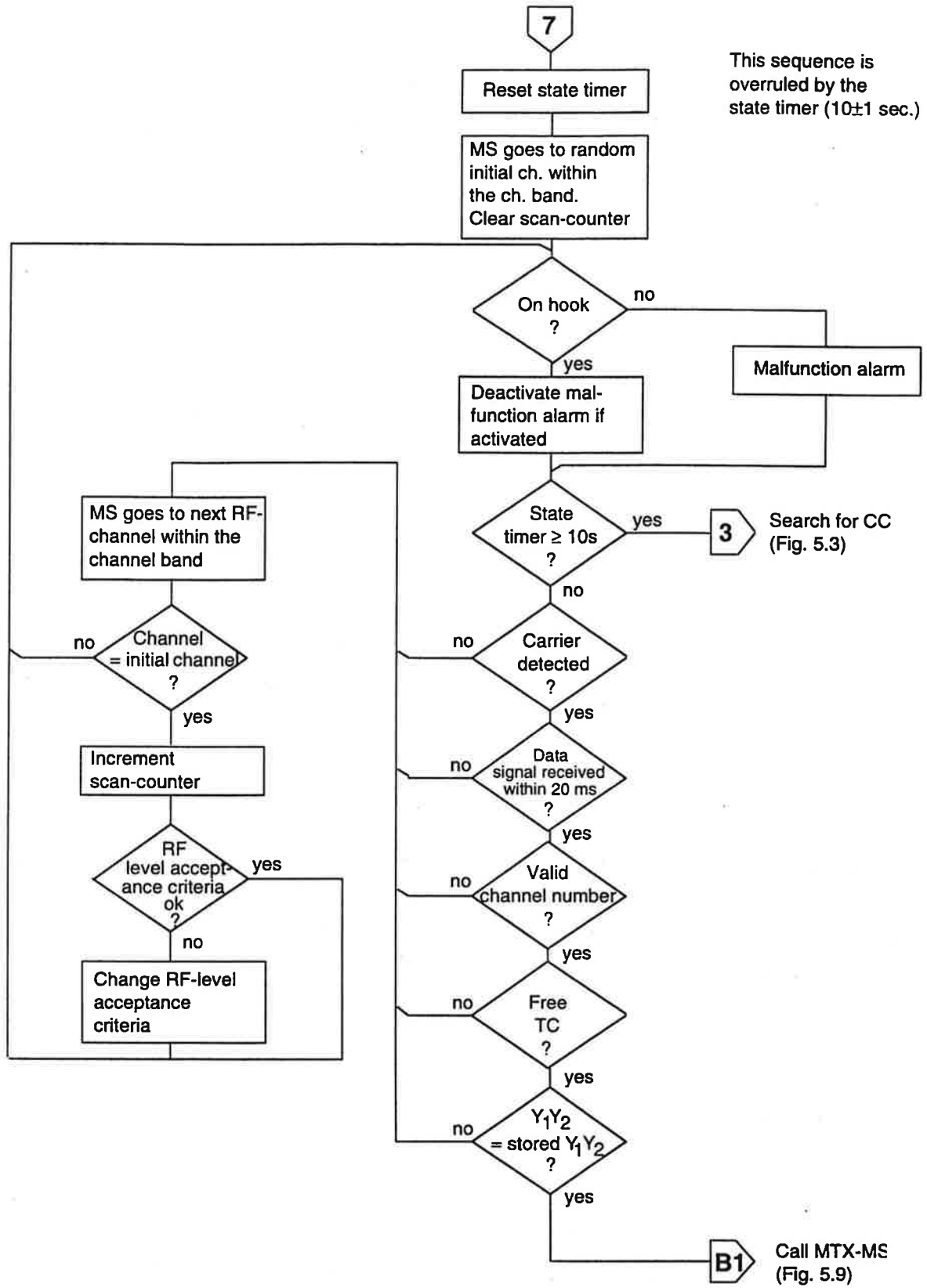

Fig. 5.6

5.2.1.9 Signalling schemes, (see fig 5.2. and paragraph 5.4)

The following list of signalling schemes contains states, where the MS is receiving/transmitting signals from/to the MTX. The states are described under the following headings:

- Call MS to MTX (scheme A)
- Call MTX to MS (scheme B and scheme B1)
- SCIP (scheme C)
- Roaming updating (scheme D)
- MS clearing
- Forced release
- Power change
- Authentication during conversation

All these states are entered by either input signals from the user or from the signalling equipment. The input/output relations of the LCU are described in the state tables (see paragraph 5.3). In these tables some additional logical states are used.

5.2.1.10 User initiated "on-hook" in the signalling schemes

All signalling schemes, where the MS is in "off-hook" state, are overruled by "on-hook" initiated by the user.

If the MS goes "on-hook"

- before responding on identity request, the MS shall enter the state search for CC on previous CC.
- after responding on identity request, the MS enters the state MS clearing.

5.2.1.11 User initiated "off-hook" in the signalling schemes

In some cases the MS can be in a signalling scheme when the user wants to initiate a call.

If the user initiates a call in signalling scheme B, after start transmission of frame 10a, the signalling scheme B should be carried out and the MS response this call.

5.2.1.12 Authentication procedure and encryption of B-subscriber number

MS's with added security, MSaS, contain means for an authentication of the A-subscriber number and an encryption of the B-subscriber number for mobile originated calls.

The MSaS's will be identified by the MTX as they all have a special K1 value. The authentication procedure will take place on request of the MTX at the identity request process. The MTX transmits a special frame 7, including a RAND, immediately after identity request. When receiving this information, the MS shall calculate an SRES and B-key within 600 ms, according to the algorithms defined in NMT Doc 450-1.

As soon as possible after the transmission of the ID (frames 10b), the MS shall transmit an authentication response, frame 16. If necessary, the time between the end of the transmission of frames 10b and the start of the frames 16 transmission, might be filled with idle frames transmission (frames 15). The B-key will be used to encrypt the B-subscriber number at the transmission of this to the MTX.

The details are shown in the relevant parts of the signalling schemes, state tables and flow charts.

5.2.2 Minor states within the signalling schemes

The signalling schemes may be divided in some minor states which describe some of the details concerning the signalling between MS and MTX. Actions to be taken in the various states are described in detail in paragraph 5.3.

Wait for identity and authentication request is the state where the MS is waiting for an identity request (frame 3b) and if the MS is equipped with added subscriber identity security an authentication request (frame 7) from MTX before continuing in signalling schemes A, B, B1, C and D.

The state is overruled by a time-out device set to T or T' ms as specified in the state tables. If the time elapses the MS shall in:

- Scheme A: Go "on-hook" and enter the state search for CC on previous CC. One repeated seizure attempt is allowed after new search for TC. (If not 1st attempt).
- Scheme B: Enter the state search for CC on previous CC.
- channel- Scheme B1: Enter the state search for CC on randomly selected channel within the band. (If not 1st attempt).
- Scheme C: Return to previous TC.
- Scheme D: Enter the state search for CC on the new CC and activate the roaming alarm indicator. (If not 1st attempt).

Wait for channel order on CC is a state which is reached after receiving a call from MTX on the calling channel. It is overruled by a time-out device set to 2T ms. If this time elapses the MS enters the standby state.

Wait for proceed to send (frame 5a(L=3/11)) is a state in signalling scheme A, where the MS waits for permission to send the stored dialled digits to MTX. It is overruled by a time-out device set to T ms. If the time elapses the MS shall initiate MS clearing (see paragraph 5.4.7) and go electrically "on-hook".

Wait for roaming updating confirmation (frame 5a(L=3)): This is a state in signalling scheme D where the MS is waiting for the frame 5a(L=3) indicating that the roaming updating is registered in the MTX. This must be

received within T ms. If the time elapses the roaming alarm indicator shall be activated and MS clearing initiated.

Wait for address complete is the state in signalling scheme A, where the MS waits for acknowledgement of the transmitted dialled digits. It is overruled by a time-out device set to 30 sec. after the last transmitted digit. If the time elapses the MS shall initiate MS clearing and go electrically "on-hook".

Wait for ringing order is the state in signalling schemes B and B1, where the MS waits for ringing order 5a(L=9). It is overruled by a time-out as specified in paragraph 5.4. If the time elapses the MS shall then initiate MS clearing and go electrically "on - hook".

Transmit dialled digits is the state following the "proceed to send" (frame 5a(L=3/11)) in scheme A. Encoded digits are transmitted if L=11 is received.

Wait for channel order on TC is the state in conversation state, where the MS receives channel order. Then it enters signalling scheme C.

Furthermore, frame 3a can also contain an order for power change on the actual channel or on the new channel.

All these states are overruled by reception of forced release from MTX or time-out in MS.

Note: T = 1107 ms (eight frames)
T' = 553 ms (four frames)
T'' = 30 ± 2,5 ms
T''' = 277 ms (two frames)

5.2.3 Task description

A task is defined as executing a transition from one state to an another state. All states and tasks are overruled by autonomous time-out.

5.2.3.1 Power on task

The power on task shall be executed whenever the battery voltage to the mobile station has been below V volts for at least a time t_V and the voltage changes from below V volts to above V volts. The maximum value of t_V and V shall be stated by the manufacturer. This voltage V need not be the same voltage V as mentioned in paragraph 5.2.1.1.

The power on task shall:

- place the transmitter in the carrier-off state;
- place the transmitter and receiver audio circuits in the muted position;
- clear all the registers except those specified in paragraph 5.2.1.1.

After this task the MS shall enter the state search for CC on a randomly selected channel within the channel band.

5.2.3.2 Power off task

The power off task shall store the information specified in paragraph 5.2.1.1.

5.2.3.3 Selection of random channel

The purpose of this task is to distribute the call attempts from each MS uniformly among the channels.

5.2.3.4 Timing supervision.

This task supervises all the timing specified in chapter 5.6.

5.3 INPUT/OUTPUT STATE RELATIONS

The states and tasks described in chapter 5.2 are connected to each other by the different procedures and signalling schemes. The input/output state relations of the Logic and Control Unit are described in the state tables. In those tables, some of the signalling schemes are broken down to the level corresponding to the flow diagrams. The information in the state tables is therefore not to be considered as a complete description of all processes in the MS.

5.3.1 Structure of the state tables

The following states will be described in detail:

- OFF State
- Standby state
- Search for calling channel (CC)
- Search for TC, MS off hook
- Search for TC, MS on hook, test for roaming
- Search for TC, MS on hook, no test for roaming
- Conversation state
- Signalling state

The description of the signalling state will be based on the level for minor states. Each of these minor states is characterised by the following input:

- Order received correctly
- Order not received correctly
- Forced release

1. All states

State No.	Initial state	Input		Response			Next state or procedure
		From user	From MTX	To user	To MTX	In MS	
1.1	Off condition	Power on		On/off indicator on		MS to random channel	Search for CC
1.2	All states, MS not transmitting	See paragraph 5.6.6 (autonomous time out)		On/off indicator off		Power off. Store Y ₁ Y ₂ . Store roaming alarm status inf. Store preprogrammed addresses.	Off condition
1.3	All states, MS transmitting	See paragraph 5.6.6 (autonomous time out)		On/off indicator off	Transmit clearing	Power off. Store Y ₁ Y ₂ . Store roaming alarm status inf. Store preprogrammed addresses. Compander off if activated.	Off condition
1.4	All states, MS not transmitting	Power off		On/off indicator off		Store Y ₁ Y ₂ . Store roaming alarm status inf. Store preprogrammed addresses.	Off condition
1.5	All states, MS transmitting	Power off		On/off indicator off	Transmit clearing	Store Y ₁ Y ₂ . Store roaming alarm status inf. Store preprogrammed addresses. Compander off if activated.	Off condition

Note: MS to random channel means random channel , unless otherwise stated

2. All states

State No.	Initial state	Input		Response			Next state or procedure
		From user	From MTX	To user	To MTX	In MS	
2.1	All states with malfunction alarm activated	On hook		Malfunction alarm off		Remain in present state	State not changed
2.2	All states with malfunction alarm activated	No action within (30±5) sec.		On/off indicator off		Power off. Store Y ₁ Y ₂ . Store roaming alarm status inf. Store preprogrammed addresses.	Off condition
2.3	All states from received identity request to clearing sequences (both included)	Change of country sel.		Alternatively 1) Malfunction alarm (if mechanically off hook) 2) None	Alternatively 1) Transmit clearing 2) None	Alternatively 1) Leave the actual state. MS to random channel. Compander off if activated. 2) Do not accept the change of country code before entering the standby state or search for CC	1) Search for CC (of new country) 2) State not changed

3. Standby state

State No.	Initial state	Input		To user	Response		Next state or procedure
		From user	From MTX		To MTX	In MS	
3.1	Standby		CC with valid Y ₁ Y ₂	Service ind. on			Standby
3.2	Standby		Call to MS		Transmit acknowl.		Wait for channel order
3.3	Standby		Scanning order to MS	Service ind. off			Search for TC (scheme B1)
3.4	Standby		Loss of CC lock	Service ind. off		MS initiates scanning	Search for CC
3.5	Standby	Off hook (dialled digits memory not empty)		Service ind. off		Store CC channel number. MS to random channel	Search for TC (scheme A)
3.6	Standby	Off hook (dialled digits memory empty. Roaming alarm ind. off)		Malfunction alarm		Remain in present state (no signalling initiated) MS electrically on hook	Standby (with malfunction alarm activated)
3.7	Standby	Off hook (roaming alarm activated)		Service ind. off		Store CC channel number. MS to random channel	Search for TC (scheme A)
3.8	Standby	Change of country selector		Service ind. off		Clear Y ₂ . Accept Y ₁ according to selected country. MS to random channel	Search for CC (of new country)

4. Search for CC

State No.	Initial state	Input		Response			Next state or procedure
		From user	From MTX	To user	To MTX	In MS	
4.1	Search for CC		No CC			MS to next channel	Search for CC
4.2	Search for CC	Off hook (dialled digits memory not empty)		Malfunction alarm		(MS to random chan.)	Search for TC (scheme A)
4.3	Search for CC	Off hook (dialled digits memory empty. Roaming alarm ind. off)				Remain in present state (no signalling initiated)	Search for CC (with malfunction alarm activated)
4.4	Search for CC	Off hook (roaming alarm activated)				(MS to random chan.)	Search for TC (scheme A)
4.5	Search for CC		CC with previous Y ₁ Y ₂	Service ind. on		Lock to CC	Standby
4.6	Search for CC		CC with new Y ₁ Y ₂			MS to next channel (set test for roaming)	Search for CC (test for roaming)
4.7	Search for CC (test for roaming)		No CC with previous Y ₁ Y ₂ detected in 2 scans. New Y ₁ Y ₂ detected twice			Store new Y ₁ Y ₂ . Set roaming flag	Search for TC (roaming flag set) (scheme D)

Note: Previous Y₁Y₂ means match with the stored Y₁Y₂

8. Minor state: Wait for channel order, schemes B and B1

State No.	Initial state	Input		Response			Next state or procedure
		From user	From MTX	To user	To MTX	In MS	
8.1	Wait for channel order		Channel order received	Service ind. off		MS to the ordered channel	Wait for identity req. (scheme B)
8.2	Wait for channel order		No order received within 2T			Remain on same channel	Standby
8.3	Wait for channel order	Off hook		Clear dialled digits display. Malfunction alarm.		Proceed scheme B. Clear dialled digits memory. MS on hook.	Wait for channel order (With malfunction alarm)
8.4	Wait for channel order		Scanning order (2d) received	Service ind. off		MS to random channel	Search for TC (scheme B1)
8.5	Wait for channel order		Queuing information (2f) received			Remain on the same channel with the locking criteria (5.2.1.2)	Standby

9. Minor state: Wait for identity request, scheme A

State No.	Initial state	Input		Response			Next state or procedure
		From user	From MTX	To user	To MTX	In MS	
9.1	Wait for identity req. (scheme A)		Identity req. and/or authentication req. received		Transmit identity followed by signed response (if authentication request received), and idle frames. See note below!		Wait for proceed to send (scheme A)
9.2	Wait for identity req. (scheme A). First attempt		No identity req. received within T			MS to random channel	Search for TC (scheme A)
9.3	Wait for identity req. (scheme A). Second attempt		No identity req. received within T	Malfunction alarm. Clear dialled digits display		MS to previous CC. MS electrically on hook. Clear dialled digits memory	Search for CC (with malfunction alarm activated)
9.4	Wait for identity req. (scheme A)		Forced release received	Malfunction alarm. Clear dialled digits display	Transmit clearing	MS to previous CC. MS electrically on hook. Clear dialled digits memory	Search for CC (with malfunction alarm activated)
9.5	Wait for identity req. (scheme A)	On hook		Clear dialled digits display		MS to previous CC. Clear dialled digits memory	Search for CC

Note: The MS shall start transmission of frame 10b/12 after analysis of the frame following next to frame 3b. The MS shall accept the first correctly received frame 7 from MTX, received within T after start transmit frame 10b, or until frame 5a(L=3/1) is received.

10. Minor state: Wait for identity request, scheme B

State No.	Initial state	Input		Response			Next state or procedure
		From user	From MTX	To user	To MTX	In MS	
10.1	Wait for identity req. (scheme B)		Identity req. received		Transmit identity		Wait for ringing order (scheme B)
10.2	Wait for identity req. (scheme B)		No identity req. received within T			MS to previous CC	Search for CC
10.3	Wait for identity req. (scheme B)		Forced release received		Transmit clearing	MS to previous CC	Search for CC
10.4	Wait for identity req. (scheme B)	Off hook		Clear dialled digits display. Malfunction alarm		Proceed scheme B. Remain on hook. Clear dialled digits memory	Wait for identity request (scheme B) (with malfunction alarm activated)

11. Minor state: Wait for identity request, scheme B1

State No.	Initial state	Input		Response			Next state or procedure
		From user	From MTX	To user	To MTX	In MS	
11.1	Wait for identity req. (scheme B1)		Identity req. received		Transmit identity		Wait for ringing order
11.2	Wait for identity req. (scheme B1) First attempt		No identity req. received within T				Search for TC (scheme B1)
11.3	Wait for identity req. (scheme B1) Second attempt		No identity req. received within T			MS to random initial channel	Search for CC
11.4	Wait for identity req. (scheme B1)		Forced release received		Transmit clearing	MS to random initial channel	Search for CC
11.5	Wait for identity req. (scheme B1)	Off hook		Clear dialled digits display. Malfunction alarm		Proceed scheme B1. Remain on hook. Clear dialled digits memory	Wait for identity req. (scheme B1) (with malfunction alarm activated)

12. Minor state: Wait for identity request, scheme C and C2'

State No.	Initial state	Input		Response			Next state or procedure
		From user	From MTX	To user	To MTX	In MS	
12.1	Wait for identity request (scheme C)		Identity request received	(Conversation on new TC)	Transmit identity	Open speech path. Throughconnect supervisory signal	Conversation
12.2	Wait for identity request (scheme C)		No identity request received within T'	(Conversation on previous TC)		MS to previous TC. Open speech path. Throughconnect supervisory signal	Conversation
12.3	Wait for identity request (scheme C and C2')		Forced release received	Malfunction alarm	Transmit clearing	MS to previous CC. Compander off if activated.	Search for CC (with malfunction alarm activated)
12.4	Wait for identity request (scheme C)	On hook			Transmit clearing	Wait for forced release in max. T. MS to previous CC. Compander off if activated.	Search for CC
12.5	Wait for identity request (scheme C2')		RF level above limit A 20 ± 4 dB (μ V) E.M.F.		Transmit identity (1 frame)	Open speech path. Throughconnect supervisory signal	Conversation
12.6	Wait for identity request (scheme C2')		RF level below limit A 20 ± 4 dB (μ V) E.M.F. Identity req. received		Transmit identity	Open speech path. Throughconnect supervisory signal	Conversation
12.7	Wait for identity request (scheme C2')		RF level below limit A 20 ± 4 dB (μ V) E.M.F. Identity req. not received within T			MS to previous TC. Open speech path. Throughconnect supervisory signal	Conversation

13. Minor state: Wait for identity request, scheme D

State No.	Initial state	Input		Response			Next state or procedure
		From user	From MTX	To user	To MTX	In MS	
13.1	Wait for identity req. (scheme D)		Identity req. received		Transmit roaming updating seizure followed by idle frames		Wait for roaming updating confirmation (scheme D)
13.2	Wait for identity req. (scheme D) First attempt		No identity req. received within T			MS to random channel	Search for TC (scheme D)
13.3	Wait for identity req. (scheme D) Second attempt		No identity req. received within T	Roaming alarm indicator on		MS to "new" CC	Search for CC (with roaming alarm activated)
13.4	Wait for identity req. (scheme D)		Forced release received	Roaming alarm indicator on	Transmit clearing	MS to "new" CC	Search for CC (with roaming alarm activated)
13.5	Wait for identity req. (scheme D)	Off hook		Malfunction alarm. Clear dialled digits display		Proceed scheme D. Clear dialled digits memory	Wait for identity req. (scheme D) (with malfunction alarm activated)

14. Minor state: Wait for roaming updating confirmation, scheme D

State No.	Initial state	Input		Response			Next state or procedure
		From user	From MTX	To user	To MTX	In MS	
14.1	Wait for roaming updating confirmation (scheme D)		Received roaming updating confirmation	Roaming alarm indicator off (if activated)	Transmit clearing	MS to "new" CC	Search for CC
14.2	Wait for roaming updating confirmation (scheme D)		No roaming updating confirmation received within T	Roaming alarm indicator on	Transmit clearing	MS to "new" CC. Wait for forced release in max. T	Search for CC (with roaming alarm activated)
14.3	Wait for roaming updating confirmation (scheme D)		Forced release received	Roaming alarm indicator on	Transmit clearing	MS to "new" CC	Search for CC (with roaming alarm activated)
14.4	Wait for roaming updating confirmation (scheme D)	Off hook		Malfuction alarm. Clear dialled digits display		Proceed scheme D. Clear dialled digits memory.	Wait for roaming updating confirmation (scheme D) (with malfuction alarm activated)

15. Minor state: Wait for proceed to send, scheme A

State No.	Initial state	Input		Response			Next state or procedure
		From user	From MTX	To user	To MTX	In MS	
15.1a	Wait for proceed to send (scheme A)	(Dialled digits memory not empty)	Received proceed to send (frame 5a(L=3))	Roaming alarm off (if activated)	Transmit preselected digits followed by idle frames. See note below	Open speech path. Throughconnect supervisory signal	Wait for address complete
15.1b	Wait for proceed to send (scheme A)	(Dialled digits memory not empty)	Received proceed to send (frame 5a(L=11))	Roaming alarm off (if activated)	Transmit preselected digits in encoded form, followed by idle frames. See note below	Open speech path. Throughconnect supervisory signal	Wait for address complete
15.2	Wait for proceed to send (scheme A)	(Dialled digits memory empty)	Received proceed to send (frame 5a(L=3/11)) (Roaming updating confirmation)	Roaming alarm off (if activated). Malfunction alarm	Transmit clearing	Wait for forced release in max. T MS to previous CC. MS on hook.	Search for CC (with malfunction alarm activated)
15.3	Wait for proceed to send (scheme A)		No proceed to send (roaming updating conf.) received within T	Malfunction alarm	Transmit clearing	Wait for forced release in max. T MS to previous CC. MS electrically on hook.	Search for CC (with malfunction alarm activated)
15.4	Wait for proceed to send (scheme A)		Forced release received	Malfunction alarm. Clear dialled digits display	Transmit clearing	MS to previous CC. Clear dialled digits memory	Search for CC (with malfunction alarm activated)
15.5	Wait for proceed to send (scheme A)	On hook		Clear dialled digits display	Transmit clearing	Wait for forced release in max. T MS to previous CC. Clear dialled digits memory.	Search for CC

Note: The MS shall accept the first correctly received frame 7 from MTX, received within T after start transmit frame 10b, or until frame 5a(L=3/11) is received.

16. Minor state: Wait for address complete, scheme A

State No.	Initial state	Input		Response			Next state or procedure
		From user	From MTX	To user	To MTX	In MS	
16.1	Wait for address complete		Address complete received				Stop transmit idle frames Conversation
16.2	Wait for address complete		No address complete received within 30 sec.	Malfunction alarm	Transmit clearing		Close speech path. Wait for forced release in max. T. MS to previous CC. MS electrically on hook. Search for CC (with malfunction alarm activated)
16.3	Wait for address complete		Forced release received	Malfunction alarm	Transmit clearing		Close speech path. MS to previous CC. MS electrically on hook. Search for CC (with malfunction alarm activated)
16.4	Wait for address complete	On hook		Clear dialled digits display	Transmit clearing		Close speech path. Wait for forced release in max. T. MS to previous CC. Clear dialled digits memory. Search for CC

17. Minor state: Wait for ringing order, schemes B and B1

State No.	Initial state	Input		Response			Next state or procedure
		From user	From MTX	To user	To MTX	In MS	
17.1	Wait for first or next ringing order (scheme B (B1))		Ringing order received	Ringing signal. Call received indicator on		Generate ringing signal. Call received indicator on	Wait for (next) ringing order (scheme B (B1))
17.2	Wait for first ringing order (scheme B (B1))		No ringing order received within T		Transmit clearing	Wait for forced release in max. T. MS to previous CC. (MS to random channel in scheme B1)	Search for CC
17.3	Wait for first or next ringing order (scheme B (B1)) (with malfunction alarm activated)		Ringing order received	Malfunction alarm. Call received indicator on. Ringing signal		Generate ringing signal. Call received indicator on	Wait for (next) ringing order (scheme B (B1)) with malfunction alarm activated
17.4	Wait for first ringing order (scheme B (B1))	Off hook		Malfunction alarm			Wait for (first) ringing order (scheme B (B1)) with malfunction alarm activated
17.5	Wait for next ringing order (scheme B (B1))		No ringing order received within 30 sec.		Transmit clearing	Wait for forced release in max. T. MS to previous CC. (MS to random channel in scheme B1)	Search for CC
17.6	Wait for next ringing order (scheme B (B1))	Off hook		Call received indicator off	Transmit B-answer	Open speech path. Throughconnect supervisory signal	Conversation
17.7	Wait for first or next ringing order (scheme B (B1))		Forced release received		Transmit clearing	MS to previous CC. (MS to random channel in scheme B1)	Search for CC

18. Conversation state

State No.	Initial state	Input		Response		Next state or procedure
		From user	From MTX	To user	To MTX	
18.1	Conversation		Channel order to same channel (power change) received		Transmit identity	Power change based on Na info. Conversation
18.2	Conversation		Channel order to another channel (frame 3a) received			Close speech path. Disconnect supervisory signal. MS to ordered channel Wait for identity request (scheme C)
18.3	Conversation		Channel order to another channel (frame 3c) received			Close speech path. Disconnect supervisory signal. MS to ordered channel Wait for identity request (scheme C2')
18.4	Conversation		Identity req.		Transmit identity	Power change (if ordered)
18.5	Conversation		Forced release	Malfunction alarm on	Transmit clearing	Close speech path. Disconnect supervisory signal. MS to previous CC. MS electrically on hook. Compander off if activated. Search for CC (with malfunction alarm activated)
18.6	Conversation	On hook			Transmit clearing	Close speech path. Disconnect supervisory signal. Wait for forced release in max. T. MS to previous CC, compander off if activated. Search for CC

18. Conversation state (cont)

State No.	Initial state	Input		Response			Next state or procedure
		From user	From MTX	To user	To MTX	In MS	
18.7	Conversation	MS switched off by on/off switch		On/off indicator off	Transmit clearing	Wait for forced release in max. T. MS to off condition. Compander off if activated.	Off condition
18.8	Conversation	MS switched off by autonomous time out		On/off indicator off	Transmit clearing	Wait for forced release in max. T. MS to off condition. Compander off if activated.	Off condition
18.9	Conversation note: see 5.2.1.3		Activate compander (frame 5a (L=5))		Activate compander		Conversation
18.10	Conversation note: see 5.2.1.3		Deactivate compander (frame 5a (L=7))		Deactivate compander		Conversation
18.11	Conversation		Identity and authentication request received.		Transmit identity followed by signed response.		Conversation

5.4 FLOW DIAGRAMS FOR THE SIGNALLING SCHEMES

The flow diagrams in paragraph 5.2.1 and in this paragraph are explanatory guidelines only and are not exhaustive. They are not intended as detailed design schemes.

5.4.1 Main states for LCU (See flow diagrams Fig. 5.2)

This flow diagram gives the main states for the Logic and Control Unit and gives also the logical connection between them.

An explanation of the main principles for:

- Search for CC (Fig. 5.3)
 - Search for TC, MS off hook (Fig. 5.4)
 - Search for TC, roaming flag set, MS on hook (Fig. 5.5)
 - Search for TC, no roaming flag set, MS on hook (Fig. 5.6)
- is given in the paragraphs 5.2.1.4. - 8.

5.4.2 Call MS - MTX (signalling scheme A). (See flow diagram Fig. 5.7)

When the user makes a call attempt the MS shall initiate the procedure search for TC.

After locking to a traffic channel, the MS proceeds with the "call MS - MTX" procedure.

If roaming updating in scheme D is interrupted by MS off hook (combined updating and call) the roaming alarm shall be activated.

Transmit seizure

The MS shall transmit seizure (two frames 10b) with start T" after the end of received frame 4 or 1b (see also paragraph 5.6.5).

Identity request received

The MS shall receive identity request (frame 3b) within T after having transmitted the seizure (frame 10b) above, in order to proceed the call.

If identity request is not received within T after having transmitted the seizure, the MS shall initiate a second search for TC in order to make another call attempt.

Transmit identity

The MS shall transmit four frames 10b with start T'' after analyzing one frame after the received frame 3b above.

Frame 5a (L=3/11) may be received during transmission of frames 10b, 11a or 12.

Digit transmission

The digits in the dialled digits memory are transmitted consecutively after receiving frame 5a (L=3/11). If frame 5a (L=11) is received, the digits shall be transmitted in encoded form, based on the received RAND and the stored SAK in the MS. See also NMT Doc 450-1

If no RAND (but frame 5a (L=11)) has been received, the MS shall transmit four frames 13a (L=1) and return to stand by. Frame 5a (L=6) and 5a (L=13/L=15) may be received during transmission of dialled digits. The digit frame transmission shall then stop immediately.

After the last digit has been transmitted frames 15 shall be transmitted until frame 5a (L=6) has been received.

Encrypted digits transmission shall start immediately after frame 5a (L=11) has been received and frames 16 have been transmitted.

Turn off roaming alarm

When frame 5a (L=3/11) is received and if the roaming alarm is "on", the MS has been updated in the MTX and the alarm shall be turned "off".

Open loudspeaker and microphone

The speech path shall be opened when the MS has received 5a (L=3/11). However, the voice input circuit (microphone) is closed during data transmission (see paragraph 5.5.4).

Note: T = 1107 ms (eight frames)
T' = 553 ms (four frames)
T'' = (30 ± 2,5) ms
T''' = 277 ms (two frames)

A. Call MS => MTX

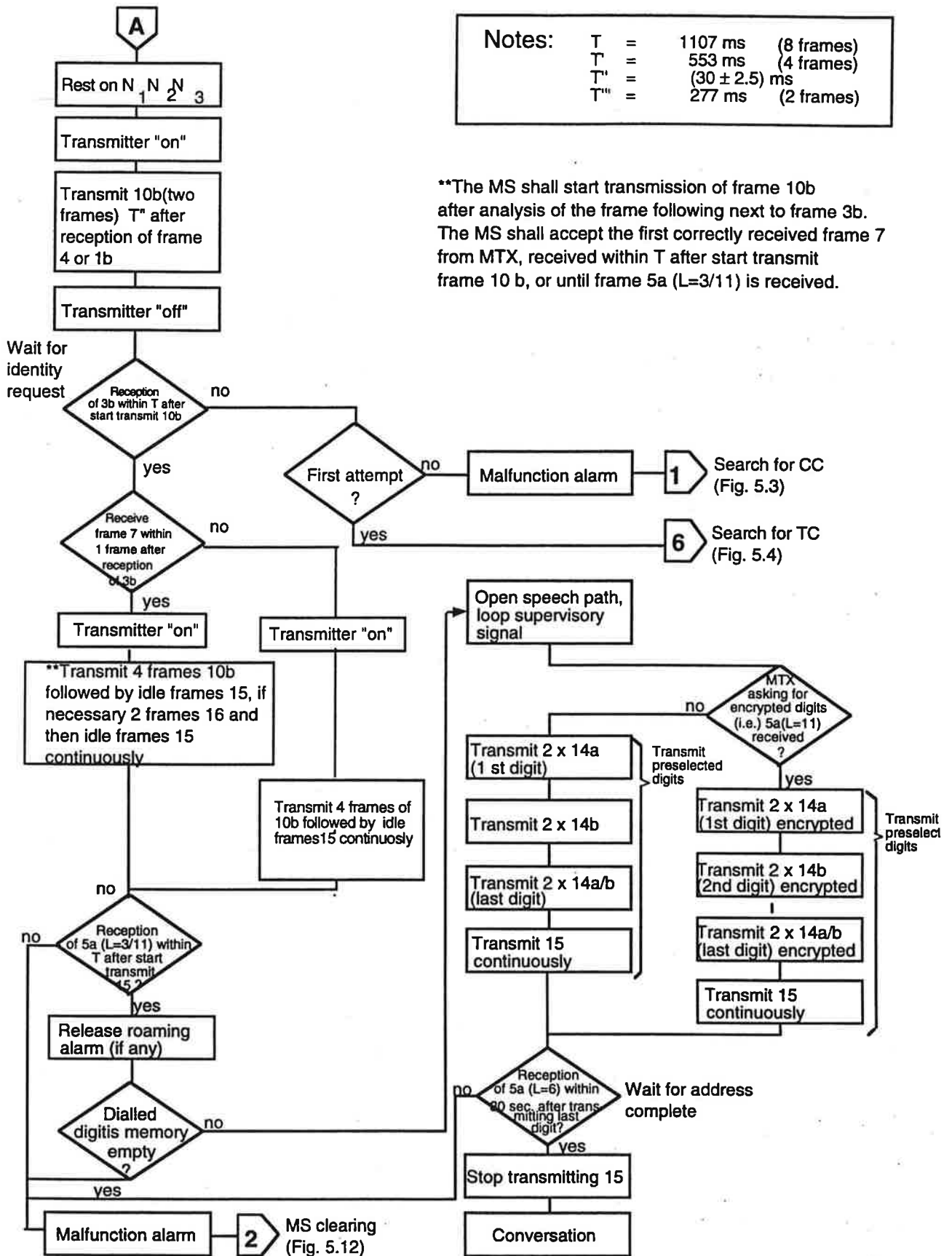

Fig. 5.7

5.4.3 Call MTX => MS (signalling scheme B). (See flow diagram Fig. 5.8)

When the MS is locked to CC it shall always be sensitive to frame 2a.

After having obtained Z $X_1..X_6$ match, the MS shall enter the "call MTX - MS" procedure.

Transmit acknowledge

The MS shall transmit a shortened frame 10a with start T" after the end of the received frame 2a,(see paragraph 5.6).

The RF output power level from the MS shall be based on an analysis of N_1 , in a number of previously received frames on the channel or determined by N_1 in frame 2a.

Received channel order

The MS shall be sensitive to:

- Channel order (frame 2b)
- Scanning order (frame 2d)
- Queuing information (frame 2f)
- Call to MS (frame 2a)

during 2 T after transmission of acknowledge (frame 10a).

If no channel order is received, the MS shall remain standby on the channel.

If channel order (frame 2b) is received the MS changes to TC $N_a N_b N_c$.

If scanning order (frame 2d) is received the MS initiates search for TC, no roaming flag set, MS on hook, see paragraph 5.2.1.8.

If queuing information (frame 2f) is received the MS shall remain standby on the channel.

If a repeated call is received, MS shall send a shortened frame as stated above for an ordinary call to MS.

During wait for channel order the MS shall still check the criteria for locking to the CC according to paragraph 5.2.1.2.

Received identity request (in signalling scheme B)

The identity request (frame 3b) must be received within T' after reception of channel order (frame 2b).

Ringling order

First ringling order (frame 5a (L=9)) is received within T after start transmission of acknowledge (frame 10b).

After reception of ringling order, the MS shall generate ringling signal according to paragraph 3.7.1.

After reception of last ringling order, the MS shall wait for next ringling order in (30 ± 5) sec.

If no ringling order is received, the MS shall transmit clearing, return to previous CC and enter the state search for CC.

B-answer

When MS goes "off hook", four frames 13a (L=14) shall be transmitted.

B. Call MTX => MS

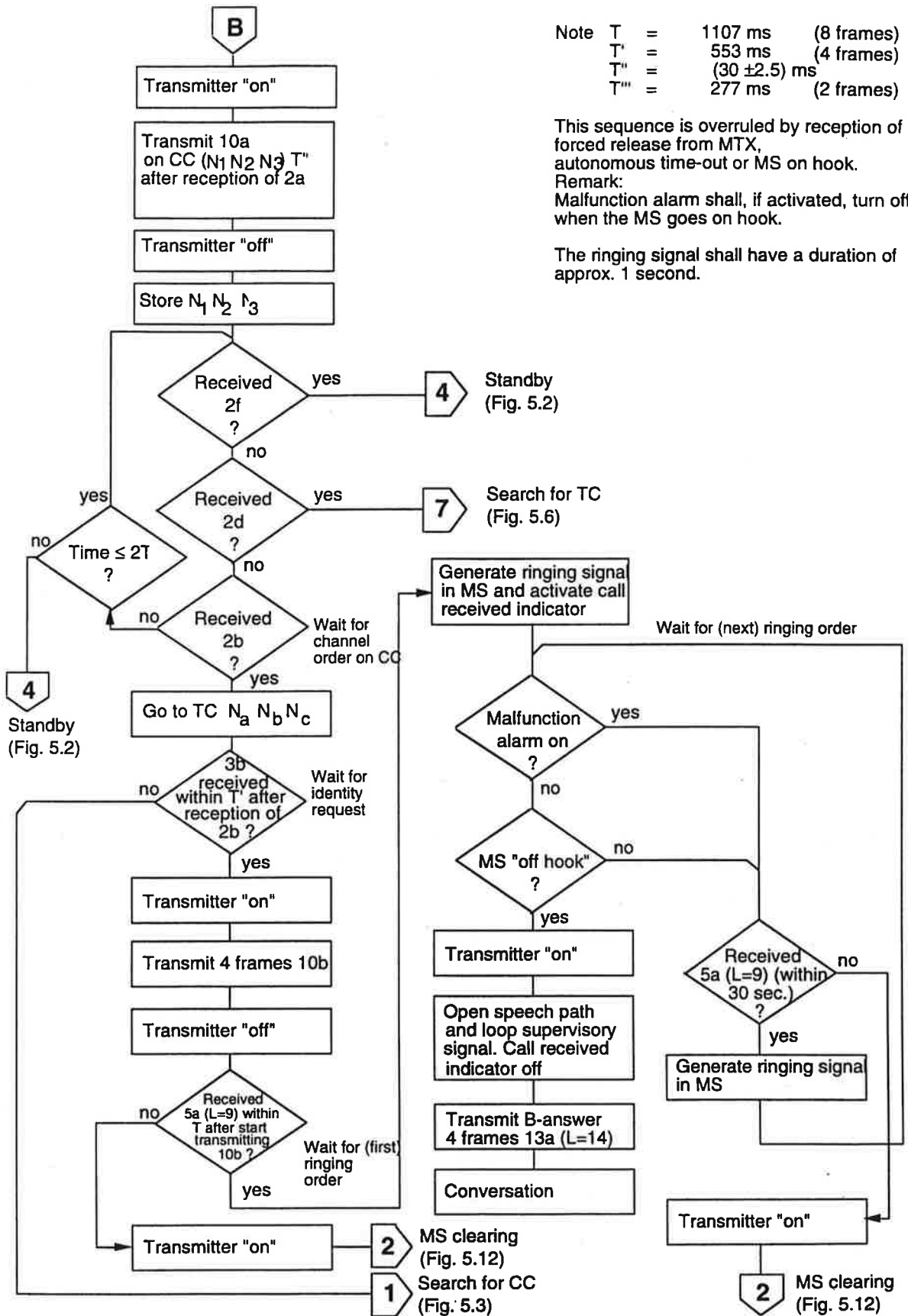

Fig 5.8

5.4.4 Call MTX=>MS (signalling scheme B1). (See flow diagram Fig. 5.9)

After successful completion of the state MS on hook, search for TC, no roaming flag set, MS enters signalling scheme B1.

After locking to the TC the MS transmits seizure (frame 10c) and waits for identity request (frame 3b).

Received identity request (in signalling scheme B1)

The MS shall receive identity request (frame 3b) within T after having transmitted the seizure (frame 10c) above, in order to proceed with the call.

If identity request is not received within T after having transmitted the seizure (frame 10c) above, the MS shall initiate a second search for TC.

Transmit identity

The MS shall transmit four frames 10c with start T" after the end of the received frame 3b above.

Ringling order

First ringling order (frame 5a (L=9)) is received within T after start transmission of acknowledge (frame 10c).

After reception of first ringling order, the MS shall wait for next ringling order in (30 ± 5) sec.

If no ringling order is received, the MS shall transmit clearing, return to previous CC and enter the state search for CC.

B-answer

When MS goes "off hook", frame 13a (L=14) shall be transmitted.

B1. Call MTX=>MS

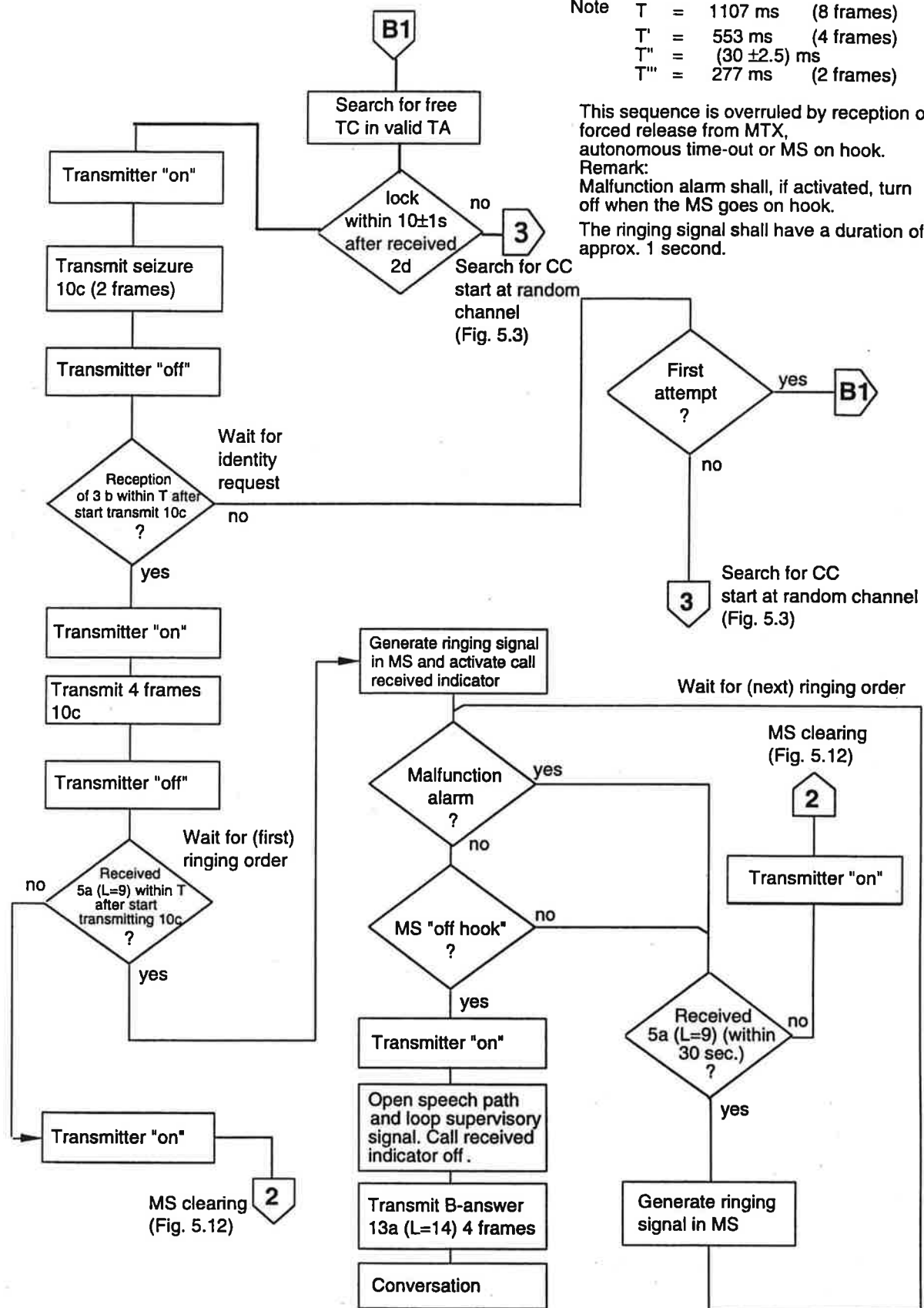

Fig. 5.9

5.4.5 Switching call in progress (SCIP) (signalling scheme C) or MS power change. (See flow diagram Fig. 5.10)

When the MS receives a channel order (frame 3a) during conversation, it can be either a **power change order** or a **channel change order**.

In the first case the MS shall change power to the ordered level indicated in N_a , transmit identity (4 frames 10b) with new power indication and continue in conversation state.

In the second case the MS shall stop the transmitting and close the speech path.

Then the MS changes to the new TC ($N'_1N'_2N'_3$) after storing $N_1N_2N_3$. The MS shall use the RF power level indicated in N_1 from received frame 3b.

If the change of channel fails for some reason (no identity check on TC $N'_1N'_2N'_3$) the MS shall go back to the previous TC ($N_1N_2N_3$). The MS shall use the RF power level indicated in the stored N_1 .

The change of channel may also imply power change depending on N_1 in frame 3b on the new channel.

When the MS receives a channel order (frame 3c) during conversation, the MS shall initiate a fast switching call in progress-procedure (signalling scheme C2') if the channel numbers indicated in $N_aN_bN_c$ and $N_1N_2N_3$ are equal.

The MS shall stop the transmitter, close the speech path and change to the new TC ($N'_1N'_2N'_3$) after storing $N_1N_2N_3$. The power level on the new channel is indicated in N_a in frame 3c, if nothing else is indicated in possible received frames 3b.

On the new channel the MS shall start transmit one frame 10b within 140 ms after reception of 3c, if the RF level exceeds level A criterion. The RF level evaluation time shall be at least 40 ms. If the level A is not exceeded, the MS shall wait for identity request for T.

C. Switching call in progress (SCIP) or MS power change

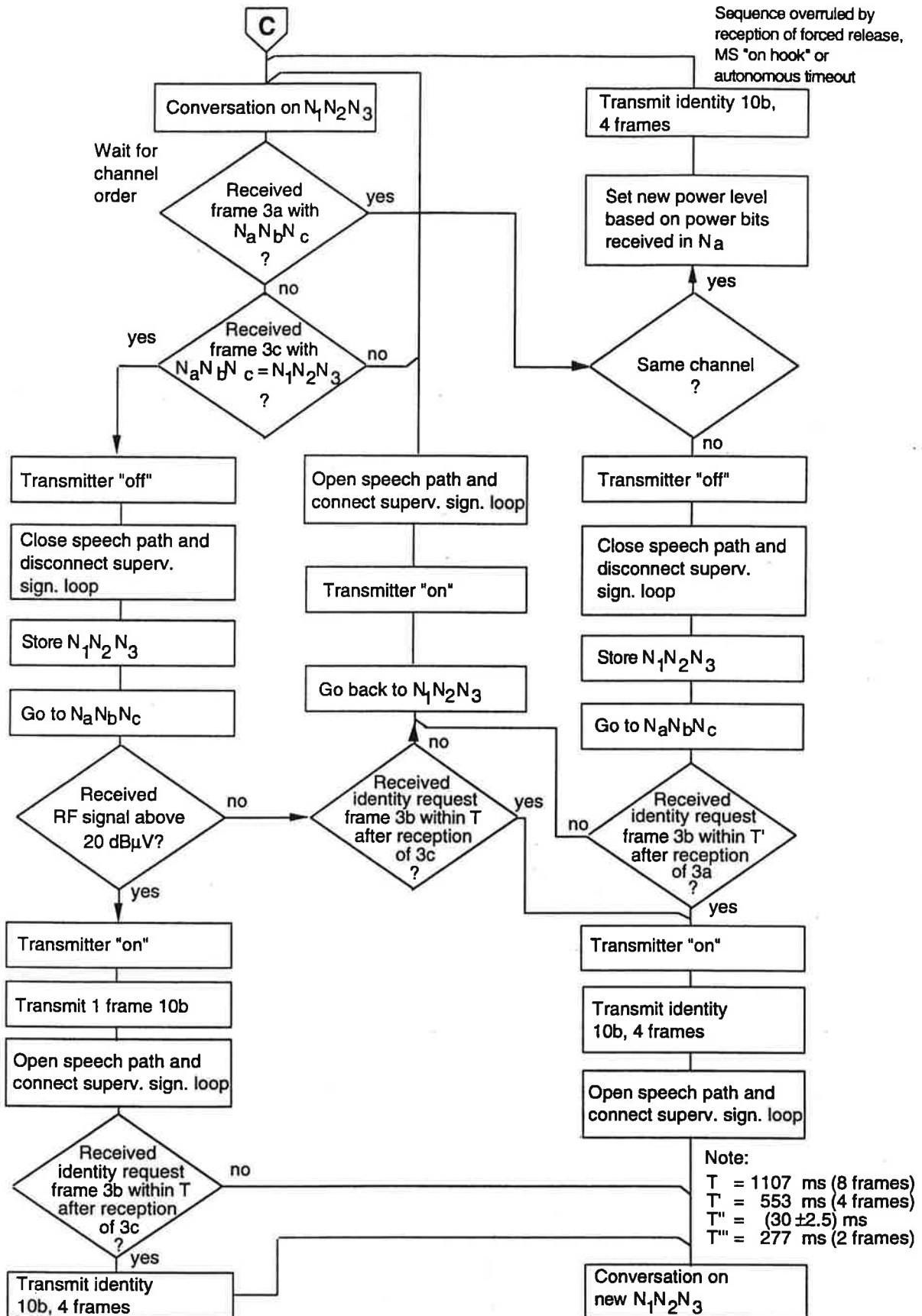

Fig. 5.10

5.4.6 Updating roaming information (signalling scheme D). (See flow chart Fig. 5.11)

See also paragraph 5.4.2.

After having found a traffic channel in the same $Y_1 Y_2$ as the new detected calling channel, the MS transmits frame 11a and waits for identity request.

If identity request is not received within T after start of transmitting frame 11a, the MS shall initiate a second search for TC in order to make another roaming updating attempt.

If identity request is not received within T after start of transmitting frame 11a, in the second attempt, the MS shall activate "Roaming alarm indicator" and go to the new CC and enter the state search for CC.

If roaming alarm state has been valid for 1 minute and a CC with the same new Y_2' is still received a second attempt for roaming updating may be initiated. If this also fails and the stored Y_2' remains the same, no more attempts to roam except manual are allowed to the same new Y_2' . If acoustic roaming alarm is used, it is recommended that it is generated only after this second (optional) unsuccessful attempt.

If identity request is received within T the MS transmits roaming updating seizure (4 frames 11a) and waits for roaming updating confirmation (frame 5a (L=3)) within T.

When frame 5 a (L=3) is received, the MS has been updated in the MTX. MS then turns off the roaming alarm indicator (if activated) and initiates clearing.

If frame 5a (L=3) is not received within T after start transmit 11a, the roaming alarm indicator shall be activated, and MS shall initiate clearing.

5.4.7 MS clearing.(See flow chart Fig. 5.12)

When MS goes "on-hook", four frames 13a (L=1) shall be transmitted. The compander shall (if activated) be switched off.

If the MS user has activated the subscriber service "Immediate call transfer", MTX will respond to the MS clearing with frame 5a (L=13).

If this service is not activated the response from MTX will be frame 5a (L=15).

MS shall wait for frame 5a (L=13 or L=15) max. T after start of the first frame 13a (L=1) in order to distinguish between the two clearing signals from MTX. When the clearing signal has been detected, or after time-out, the MS returns to previous CC and enters the state search for CC.

If MS goes "on-hook" during digit transmission, the dialled digits display shall be cleared.

5.4.8 Forced release from MTX (See flow chart Fig. 5.13)

When MS receives frame 5a (L=13 or L=15), four frames 13a (L=1) shall be transmitted. The compander shall (if activated) be switched off.

The MS returns to previous CC and enters the state search for CC.

If forced release, frame 5a (L=13 or L=15) is received during digit transmission the dialled digits memory shall be cleared. The malfunction alarm shall be activated (ref. paragraph 3.7.2.)

5.4.9 Authentication during conversation (See flow chart Fig. 5.14)

When MS receives identity and authentication request the MS shall transmit four frames 10b followed by idle frames 15, if necessary and two frames 16.

D. Updating roaming information

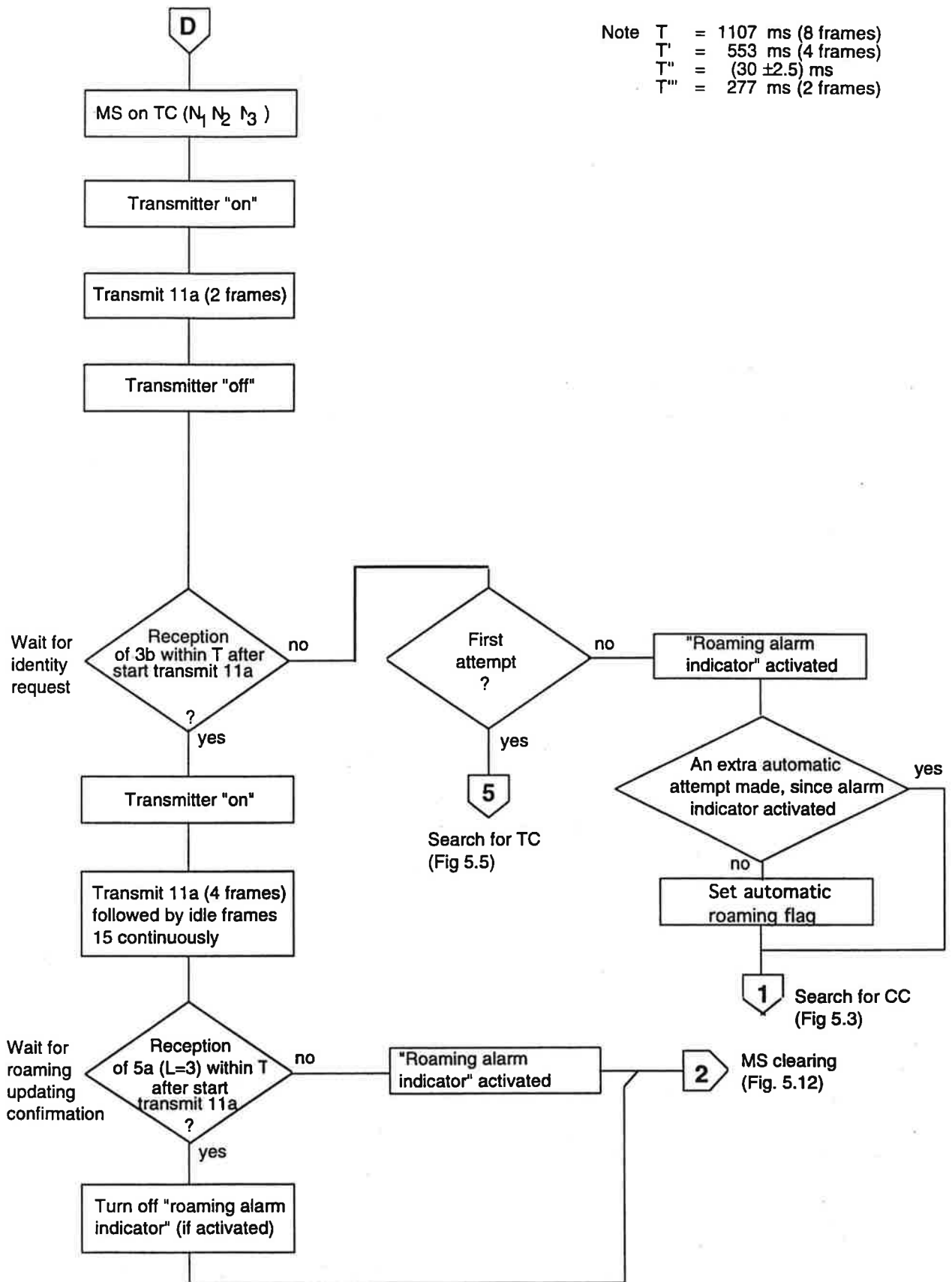

Fig. 5.11

E. MS clearing

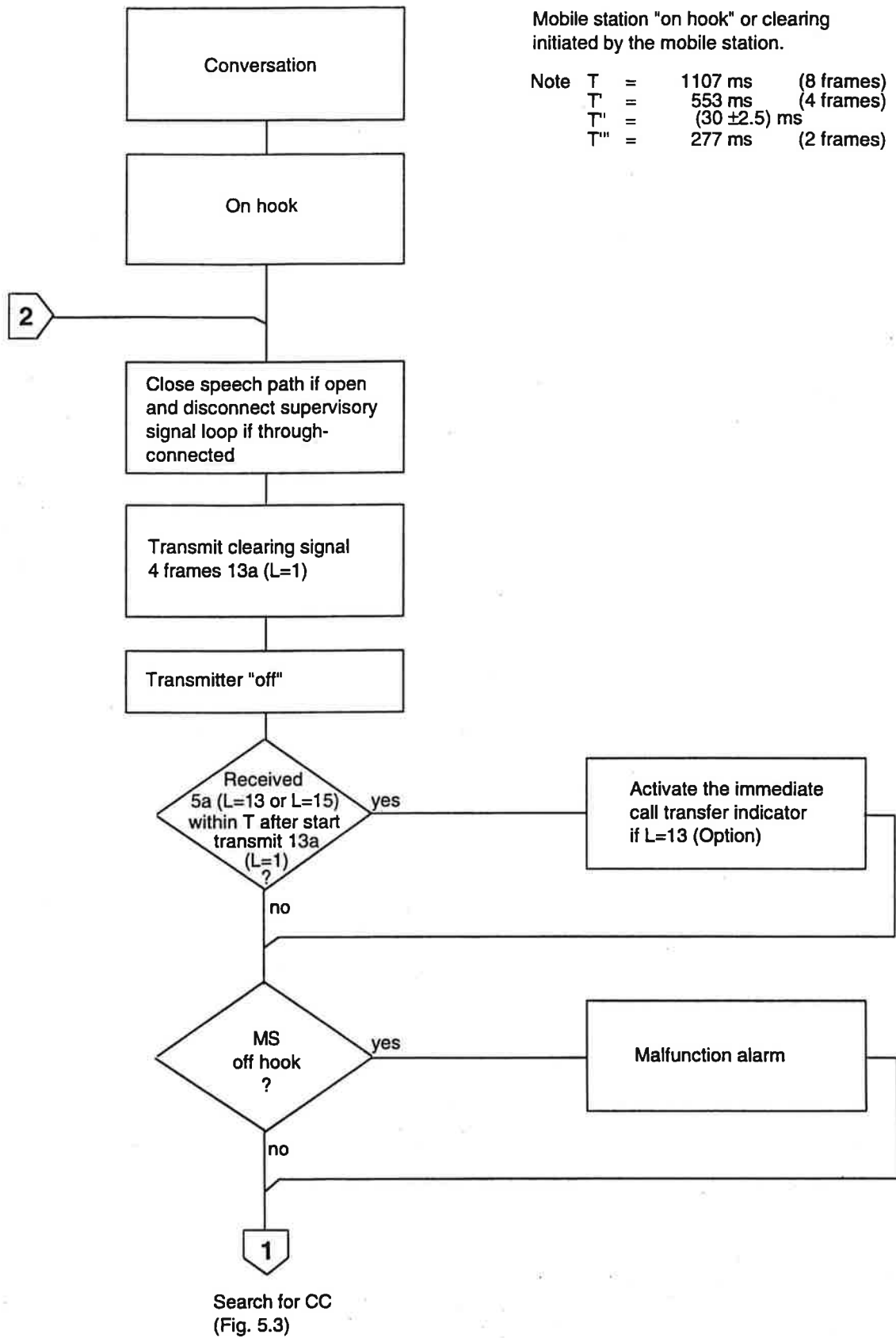

Fig 5.12

F. Forced release

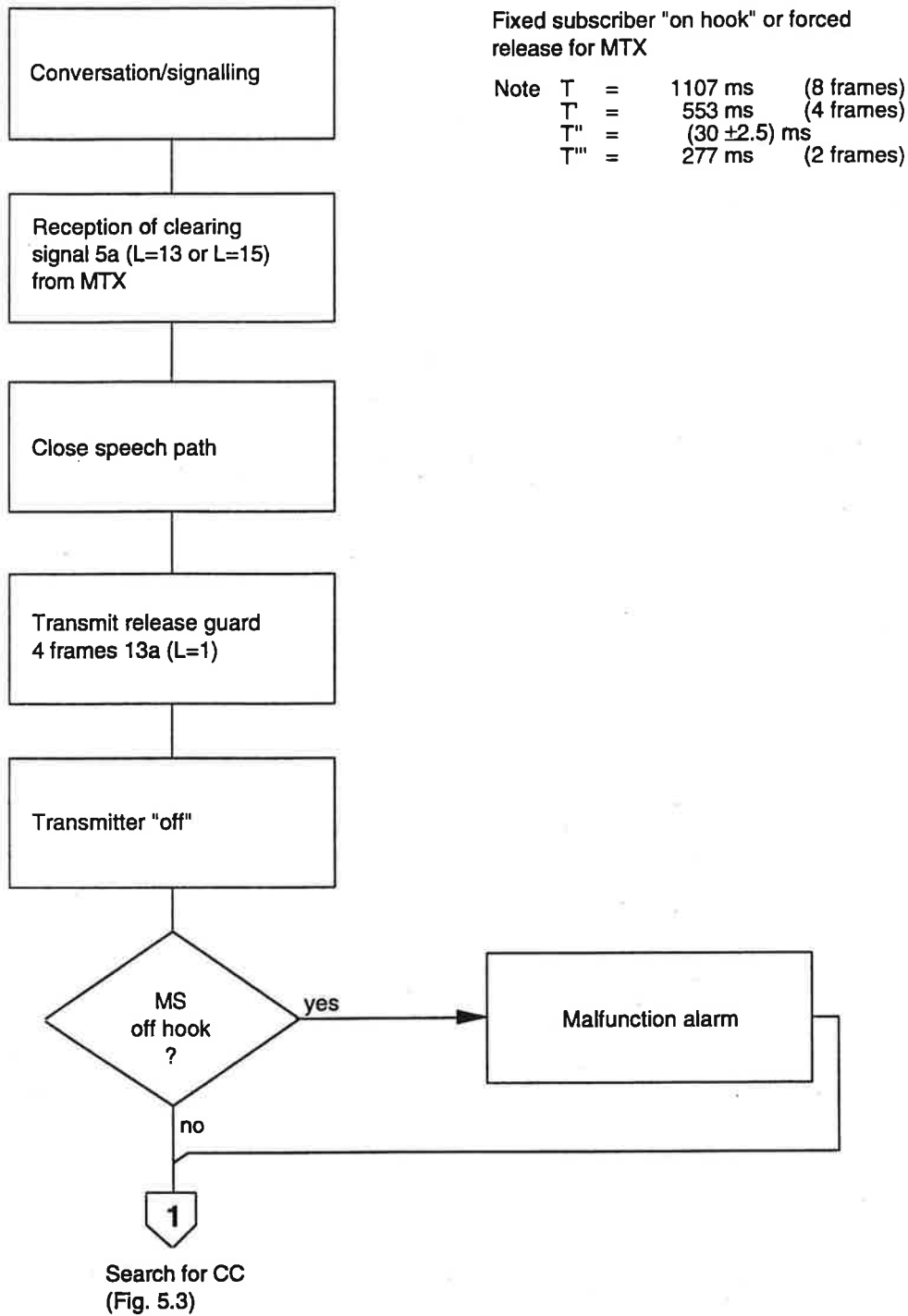

Fig. 5.13

Authentication during conversation

Note T = 1107 ms (8 frames)
T' = 553 ms (4frames)
T'' = (30 ± 2.5 ms)
T''' = 277 ms (2 frames)

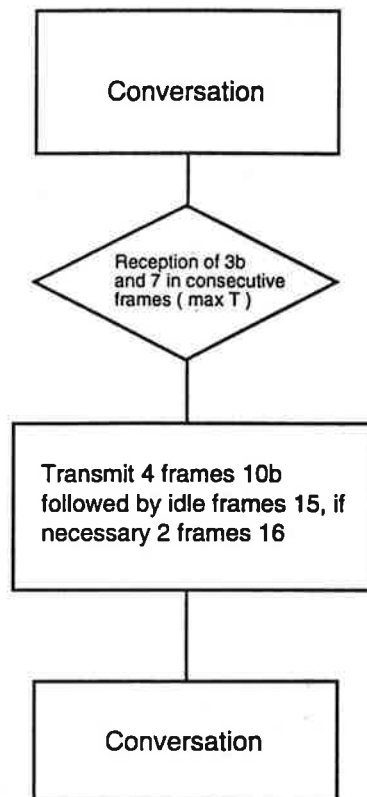

Fig 5.14

5.5 SIGNALLING EQUIPMENT FOR 1200 BAUD FFSK

5.5.1 General description

Exchange of signals between MTX and MS is performed by means of 1200 baud FFSK binary signalling.

The main characteristics and requirements for the FFSK signalling system and equipment are dealt with in NMT Doc 450-1.

5.5.2 FFSK modulation in MS

Pre-emphasis

The FFSK signal shall be modulated in such a way that it is influenced by a pre-emphasis similar to that applied to the voice input circuit. The signal shall be introduced into the transmitter after the audio muting device (paragraph 2.2.16) and shall not be affected by the compressor device.

Deviation

The FFSK signal shall produce a mean RF frequency deviation of $(\pm 3,5 \pm 0,5)$ kHz under normal and extreme test conditions. See also paragraph 1.3.8.2.

Group delay distortion

The distortion of the transmitted FFSK signals shall be measured according to paragraph 6.1.6.

5.5.3 FFSK signal receiver

The overall performance requirements for the FFSK signalling reception capability are specified in paragraph 6.1.7. The FFSK signals shall not be processed in the expander.

5.5.4 Splitting in MS

Encoding

When the MS transmits an FFSK signal, the voice input circuit and the supervisory signal loop shall automatically be closed by the muting device. See paragraph 2.2.16. However, the supervisory signal loop shall remain through connected during MFT and Register recall signalling.

Decoding

After reception of the frame synchronisation and before error correction, it is checked whether the following six information bits all have the value 0. If so, the audio output is muted. The muting device used is specified in paragraph 2.3.21. Opening of the audio path is delayed (277 ± 10) ms after reception of the last frame synchronisation.

The audio output shall not be muted by noise or signal if the noise or signal is below a level of (-18 ± 3) dB relative to the nominal level of the modem.

5.5.5 FFSK signalling detection time

The FFSK signalling receiver shall inform the Logic and Control Unit whether the RF channel is modulated with an FFSK signal or not.

This information (about RF channel N+1) shall be provided within 20 ms after the moment the Logic and Control Unit ordered the transceiver to switch from RF channel N to RF channel N+1.

5.6 TIMING IN THE MS

All time tolerances given are valid under normal and extreme test conditions.

5.6.1 Time constants in the signalling procedure

The time constants used in performing the signalling procedures shall be the following multiples of the time needed to transmit a 1200 baud signalling frame.

$T = 1107$ ms (eight frames)

$T' = 553$ ms (four frames)

$T'' = (30 \pm 2,5)$ ms

$T''' = 277$ ms (two frames)

5.6.2 Timing between the signalling directions in MS

All timing in the signalling is specified with reference to the end of the received frame.

Definitions

The time skew

The time elapsed from the end of a received frame to the end of a partly overlapping transmitted frame is called *the time skew*. Fig. 5.15 shows an example with a time skew of T_s ms.

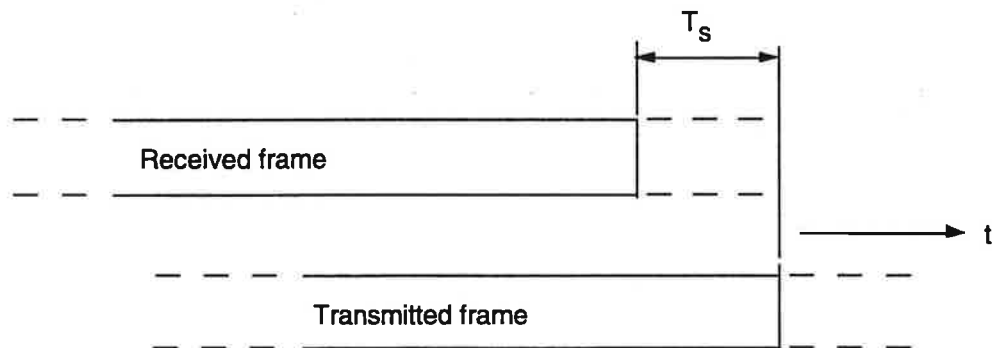

Fig 5.15 Time skew

The response time of the MS is the time elapsed from the end of the received message to the end of the transmitted message (answer). Thus the response time will be an integral number of frame times plus the time skew. Fig. 5.16 shows an example of a response time of one frame plus a time skew of T_s .

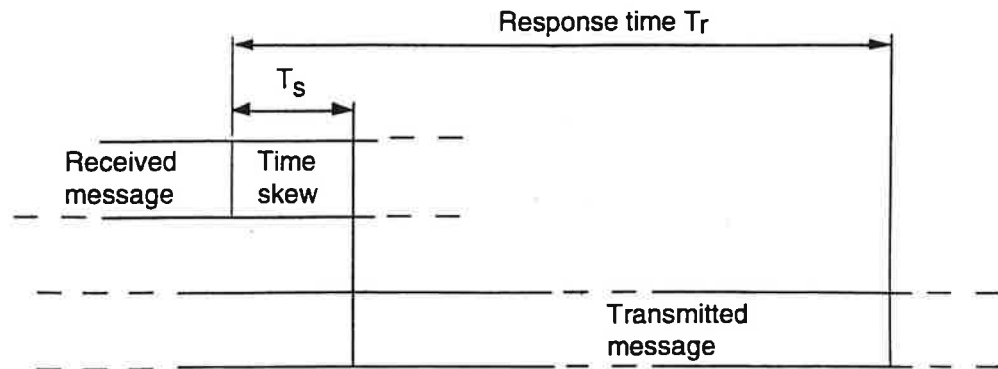

Fig 5.16 Response time

5.6.3 Timing of call acknowledgement on calling channel

After receiving a call on calling channel the MS shall start to transmit frame 10a within $(30 \pm 2,5)$ ms.

In order to decrease the risk of interference between two subsequent frames on the same channel, frames 10a shall be shortened frames where the bits after Y_{114} are deleted. The transmitter in the MS shall, however, be closed after 117 ms after the starting point of bit sync, i.e. the transmitter shall be closed after Y_{114} has been sent.

See Fig. 6.3.

5.6.4 Timing of transmission of frames 10b, 10c, 11a, 11b and 12

The timing of transmission and tolerances specified in paragraph 5.6.3 for transmission of frames 10a is also valid at transmission of frames 10b, 10c, 11a, 11b and 12, and other frames which are transmitted from MS as a response of frames from MTX on the actual channel.

5.6.5 Timing of seizure on traffic channel

The response time for seizure, frames 10b, 10c, 11a, 11b and 12, shall be one frame time plus a time skew of $(30 \pm 2,5)$ ms after the detection of frame 4, free traffic channel indication, see Fig. 5.16. The start-up and decay time tolerances shall be the same as for the call acknowledgement frame 10a.

5.6.6 Autonomous time-out

A timer, electrically separate from and independent of all other logic functions, must be running continuously whenever power is applied to the MS. Sufficient reset commands must be interspersed throughout the Logic and Control Unit to ensure that the timer never expires as long as the proper sequence of operations is taking place. If the timer expires, a failure is assumed and the power must be switched off the MS.

The time allowed for the timer is (30 ± 5) seconds under normal and extreme test conditions.

One of the functions of the timer is to switch off power when the MS is transmitting and no RF carrier is detected (see paragraph 2.3.6) within the specified time. Bursts of RF carrier up to 1 s are not considered.

If an autonomous time-out occurs because of loss of RF input signal, the MS shall enter off condition according to paragraph 5.2.1.1. If time-out occurs because of some malfunction or failure in hardware or software, e.g. continuous transmitting on calling channel or during scan, it is required that the power is switched off immediately, but the failure may prevent the MS from storing the information mentioned in paragraph 5.2.1.1.

Another example for the use of the timer is, that if the MS receives FFSK-signalling continuously for (30 ± 5) sec in conversation state, the timer shall switch off the power.

In conversation state the MS shall transmit clearing immediately before the timer switches off the power.

The power "on/off" switch must be switched manually "on" before the station may return to normal operation.

5.7 TRANSCEIVER INTERFACE

5.7.1 RF power control in MS

The RF output power level from the MS is based on the information received from the MTX. In MS the Logic and Control Unit gives control signals "carrier on/off" and power level "high", "medium" and "low" to the transceiver.

5.7.1.1 MTX controlled maximum RF output power

The MTX controls the power level of the MS by means of power bit No. 2 and 3 in N_1 or N_a (high power 11, medium power 10, low power 01 and 00) in the channel numbers of signalling frames 1, 2a, 3a, 3b, 3c, and 4 in the direction MTX to MS. The same combination $N_1 N_2 N_3$ is returned in the signalling to the MTX. The MS shall be able to reduce and increase the power level on order from MTX according to the following table.

Power level	Power bits	MS
High power	11	$P_H = 15 \text{ W} \pm 1.5 \text{ dB}$ or $P_H = 7 \text{ W} \pm 1.5 \text{ dB}$
Medium power	10	$P_M = 15 \text{ W} - (10 \pm 3 \text{ dB})$
Low power	01	$P_L = 15 \text{ W} - (20 \pm 3 \text{ dB})$
Low power	00	$P_L = 15 \text{ W} - (20 \pm 3 \text{ dB})$

Measurements are made under normal and extreme test conditions.

In digits N_1 and N_a , the least significant bit (bit no. 4) denotes the hundreds digit in the channel number. Bit no.1, which from outset shall have the value "0", is reserved for future use.

In signalling between MTX and BS, the first three bits in N_1 and N_a shall have the value 011 in both directions. However, between MTX and BS special values and meanings of N_1 may be used (see paragraph 4.3.1).

The MS output power shall be controlled in the following way:

- For signalling frames on channel $N_1 N_2 N_3$ not containing a channel order $N_a N_b N_c$, the power bits in N_1 shall control the MS power level.

Signalling frames in direction MS-->MTX shall have the same power bits in N_1 as in the received frames from MTX.

- For signalling frames on channel $N_1 N_2 N_3$ containing a channel order $N_a N_b N_c$, the MS power shall be controlled by the power bits in N_a .
Signalling frames in the direction MS-->MTX shall have the same power bits in N_1 as received from MTX in N_a .

5.7.1.2 Autonomous power control in MS

If the mean RF level received in MS during conversation is above 55 dB (μ V) E.M.F. ± 5 dB for 5 seconds, the RF output power shall be reduced to low power. In the signalling towards MTX, however, the received power bits from MTX shall be used.

When the received mean RF level during conversation decreases to below 45 dB (μ V) E.M.F. ± 5 dB for 5 seconds, the RF output level shall be increased to the maximum RF output power indicated by the MTX signalling. The hysteresis shall be at least 8 dB.

5.7.2 RF frequency control

The RF frequency of the transceiver is directly controlled by the Logic and Control Unit.

The received channel number given in $N_1 N_2 N_3$ is coded according to NMT Doc 450-1.

5.7.3 Audio muting (See paragraphs 2.2.16, 2.3.21 and 5.5.4).

The audio input circuit and the audio output circuit are muted by control signals from Logic and Control Unit in accordance with signalling schemes, flow charts and state tables.

5.7.4 RF carrier detector

RF carrier detector shall inform the Logic and Control Unit and autonomous time-out device whether an RF carrier is present or not. See also paragraph 2.3.6.

6. SYSTEM TESTS

The Logic and Control Unit is checked together with the transceiver by a number of RF tests.

6.1 PERFORMANCE TESTS

6.1.1 Signalling sensitivity measured by call reception probability

This test corresponds to the test in paragraph 2.3.7.

Call reception probability is defined as the probability of receiving frame 10a from the MS after having sent frame 2a (with the identification of the MS) to the MS during the RF-conditions specified in the following paragraphs.

- a) An RF-signal with a level of 0 dB (μV) E.M.F. (50 ohms) modulated with a frame 1a to a mean frequency deviation of $\pm 3,5$ kHz is applied to the antenna. Once per 86 frames, frame 2a with the identification of the MS is transmitted. During the time of the middle 66 frames between two calls to the MS, the RF-level is increased to 15 dB (μV) E.M.F.
- b) Same as in case a) but with an RF level of 3 dB (μV) E.M.F. and a mean frequency deviation of $\pm 1,75$ kHz.

For both cases the requirement is minimum 95% call reception probability.

6.1.2 Co-channel data rejection

This test corresponds to the test in paragraph 2.3.8. The wanted signal with modulation as in paragraph 6.1.1a shall have a level of 3 dB (μV) E.M.F., and the unwanted signal with the same type of modulation but from a source independent from the source used for the wanted signal shall have a level of -5 dB (μV) E.M.F.

The requirement is minimum 95% call reception probability.

6.1.3 Adjacent RF-signal decoding degradation

This test corresponds to the test in paragraph 2.3.9. The wanted signal with modulation as in paragraph 6.1.1a shall have a level of 3 dB (μV) E.M.F., and the unwanted signal level with modulation as in paragraph 6.1.2 shall be 70 dB (μV) E.M.F.

The requirement is minimum 95% call reception probability.

6.1.4 RF intermodulation decoding degradation

This test corresponds to the test in paragraph 2.3.12. The wanted signal, modulated as in paragraph 6.1.1a, shall have a level of 3 dB (μV) E.M.F., and the two unwanted signals, one unmodulated and one modulated with random data signals to a mean frequency deviation of ± 3.5 kHz, shall have a level of 70 dB (μV) E.M.F.

The requirement is minimum 95% call reception probability.

6.1.5 Signalling sensitivity in presence of RF signal fading measured by call reception probability

The test is carried out in the same way as in paragraph 6.1.1a, but with a fading simulator (Rayleigh) connected between the system simulator and MS. The test shall be made at simulated vehicle speeds of 10, 50, and 90 km/h.

The requirement is 95% call reception probability for an RF signal level with an r.m.s. value of 10 dB (μV) E.M.F.

Note: The fading simulator may consist of 2 non-correlated digital pseudo-random generators with 3rd order digital filters to shape the noise power spectra. The bandwidth corresponds to the doppler shift of the simulated speed. The two noise sources modulate two RF signals 90° out of phase. It can be shown that the combined signal has a Rayleigh distributed amplitude.

6.1.6 Data signal distortion

The distortion of the transmitted data signal from the MS is measured in accordance with a measuring set-up shown in Fig. 6.1. The MS shall be continuously modulated with normal data test modulation as defined in paragraph 1.3.8.2.

The error rate is analysed for different S/N ratios. The required S/N ratio for error rate 10^{-4} is compared with the S/N ratio required for the same error rate when the reference FFSK transmitter is used (see NMT Doc 450-1).

For the error rate 10^{-4} , the increase in S/N when measuring the MS shall be less than 0,5 dB compared with the reference measurement.

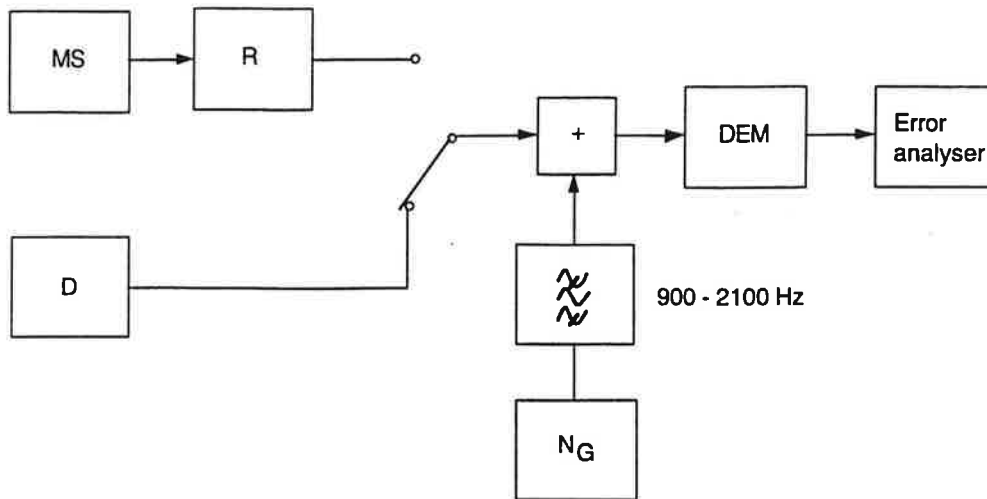

- MS* - mobile station under test
D - reference FFSK transmitter
R - reference RF receiver with de-emphasis
NG - noise generator
DEM - reference FFSK demodulator

Fig. 6.1 Measuring set-up

6.1.7 Ability to interpret distorted data signals

The distortion of data signals received by the MS consists mainly of group delay distortion, stemming from the connection MTX-BS and to a lesser extent from the BS circuitry. The ability of the MS to interpret data signals with group delay distortion is measured by feeding the MS with an RF signal modulated by predistorted data signals. The RF signal shall be modulated to an average frequency deviation of $\pm 3,5$ kHz, using the same test procedure as in paragraph 6.1.1a. The modulating signal shall be fed through a distortion circuit with a group delay characteristic as shown in Fig. 6.2.

The required RF input signal level for 95% call reception probability shall not exceed the level necessary for 95% call reception probability measured without the distortion circuit by more than 1 dB.

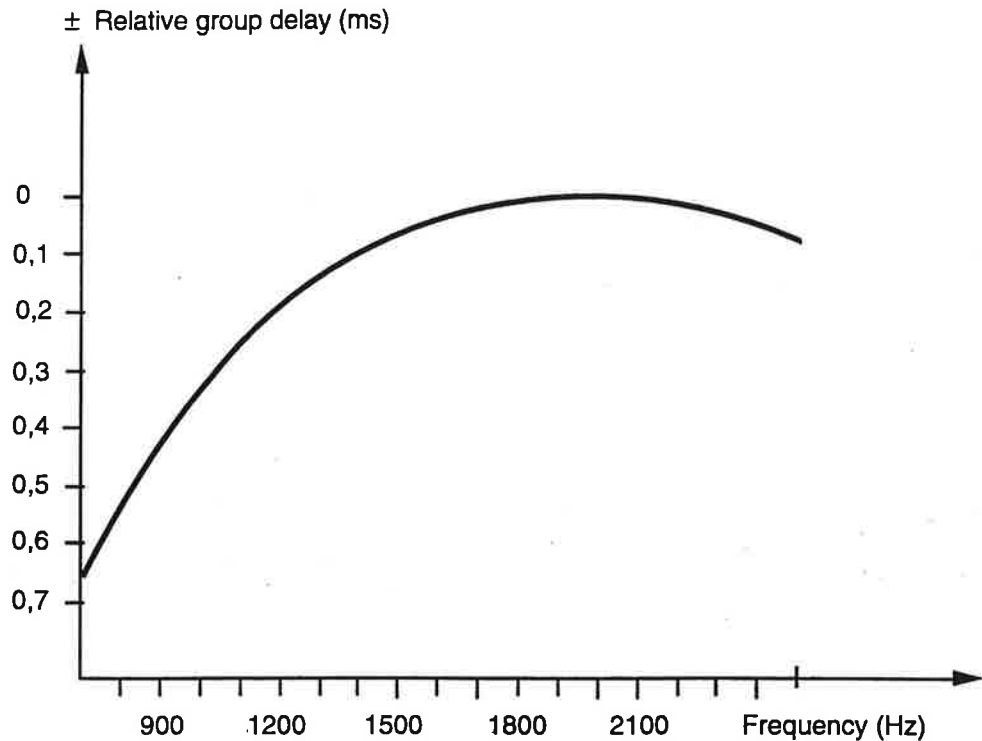

Fig. 6.2 Group delay of distortion circuit

6.2 TIME CONSTANTS

The following time constants are tested as described below. All requirements and time tolerances shall be fulfilled under normal as well as extreme test conditions.

6.2.1 Receiver switching time to next channel including FFSK detection time

The receiver switching time to next channel including FFSK detection time shall not exceed 20 ms.

6.2.2 Transmitter start-up times

6.2.2.1 Definition

The transmitter reaction time is the time elapsed between the end of the calling frame (2a) and the beginning of the call acknowledgement frame (10a) indicated as t_3 in fig. 6.3. The following partial times are of interest:

The time elapsed from the end of the calling frame until the transmitter output power is 40 dB below its steady-state value is indicated as t_1 in fig. 6.3.

The time elapsed from the transmitter output power reaches a value 2 dB below its steady-state output power until the beginning of the call acknowledgement frame is indicated as t_2 in fig. 6.3.

Because of the reaction time of the base station squelch, the MS must always wait t_2 before data signalling starts. See also paragraph 5.6.

6.2.2.2 Requirements:

$t_1 \geq 14$ ms

$t_2 \geq 10$ ms

6.2.3 Call acknowledgement on CC

The length of call acknowledgement is indicated as t_4 in fig. 6.3. The time is minimum 117 ms (determined by the parameters of the signalling system).

6.2.4 Transmitter awake time

The transmitter awake time is defined as the time elapsed from the end of the calling frame (2a) until the transmitter output power has decayed to a value 40 dB below its steady-state value and is indicated as t_5 in fig. 6.3. The maximum length is 153 ms.

6.2.5 Switching time to ordered channel

6.2.5.1 Definition

Switching time to ordered channel is the time elapsed between the end of a received channel order to an arbitrary channel (frames 2b and 3a) and the earliest moment MS is capable of reading received frames on the new ordered channel.

6.2.5.2 Method of measurements

Two RF signals with a level of 10 dB (μ V) E.M.F. are applied to the MS antenna terminal. RF signal A on channel $N_1N_2N_3$ shall, according to the signalling schemes, send a channel order to an arbitrary channel $N'_1N'_2N'_3$. RF signal B is modulated with a frame giving a response in MS. The time skew between channel order frame on channel $N_1N_2N_3$ and the frame on the channel $N'_1N'_2N'_3$ is varied until shortest possible time is elapsed between channel order and the response in MS. The time skew between the frame on channel $N_1N_2N_3$ and the frame on channel $N'_1N'_2N'_3$ is equal to the defined switching time.

6.2.5.3 Requirements

Switching time to ordered channel shall not exceed 40 ms.

6.2.6 Transient behaviour of the transmitter

6.2.6.1 Definitions

The transient frequency behaviour of the transmitter is the variation in time of the transmitter frequency difference from the nominal frequency of the transmitter when the RF output power is switched on and off.

6.2.6.2 Method of measurement

The transient timings (switch on/off cases) and the frequency errors occurring during these periods of time can be measured by means of a spectrum analyzer and a modulation analyzer. See fig 6.4.

Two signals shall be connected to the discriminator via the combining network.

The transmitter (D.U.T.) shall be connected to a 50 Ω power attenuator.

The output of the power attenuator shall be connected to the discriminator via one input of the combining network.

The test signal shall be connected to the second input of the combining network.

The test signal shall be adjusted to the nominal frequency of the transmitter.

The test signal shall be modulated by a frequency of 1 kHz with a deviation of 12.5 kHz.

The test signal shall be adjusted to correspond to -40 dB of the power of the transmitter under test measured at the input of the discriminator. This level shall be maintained throughout the measurement.

The spectrum analyzer is set to measure and display power as a function of time ("zero span mode", bandwidth as broad as possible)

The video output (ad) of the analyzer and the frequency output (fd) of the mod. analyzer (discriminator) shall be connected to a storage oscilloscope.

The display will show the 1 kHz test signal continuously.

The storage oscilloscope shall then be set to trigger on the channel corresponding to the amplitude (ad) input, rising edge.

The transmitter shall then be switched on.

The result of the change in the power ratio between the test signal and the transmitter input will, due to the capture ratio of the discriminator, produce two separate sides on the picture, one showing the 1 kHz test signal, the other the frequency of the transmitter versus time.

The moment when the 1 kHz test signal is completely suppressed is considered to provide t_{on} .

The result shall be recorded as frequency error versus time.

The transmitter shall remain switched on.

The storage oscilloscope shall be set to trigger on the channel corresponding to the amplitude (ad) input, decaying edge.

The transmitter shall then be switched off.

The moment when the 1 kHz test signal starts to rise is considered to provide t_{off} .

The result shall be recorded as frequency error versus time.

The transient frequency error shall be measured when the oscillator is stabilized on the transmit frequency. After channel switching order the frequency error shall be measured only in the start up period (t_3 in fig. 6.3)

The procedure "Call MTX to MS normal case. SCHEME B".
Ref: Signalling scheme 4.4.1.2.1 in NMT Doc 450-1 shall be used for measuring transient frequency error with stabilized oscillator.

The procedure "Switching call in progress, short procedure. SCHEME C2".
Ref: Signalling scheme 4.4.1.4.3 in NMT Doc 450-1 shall be used for measuring transient frequency error after channel switching order.

6.2.6.3 Requirements

During the period of time when the 1 kHz test signal is suppressed, the frequency error shall not exceed the values given in the appropriate template in fig 6.3.

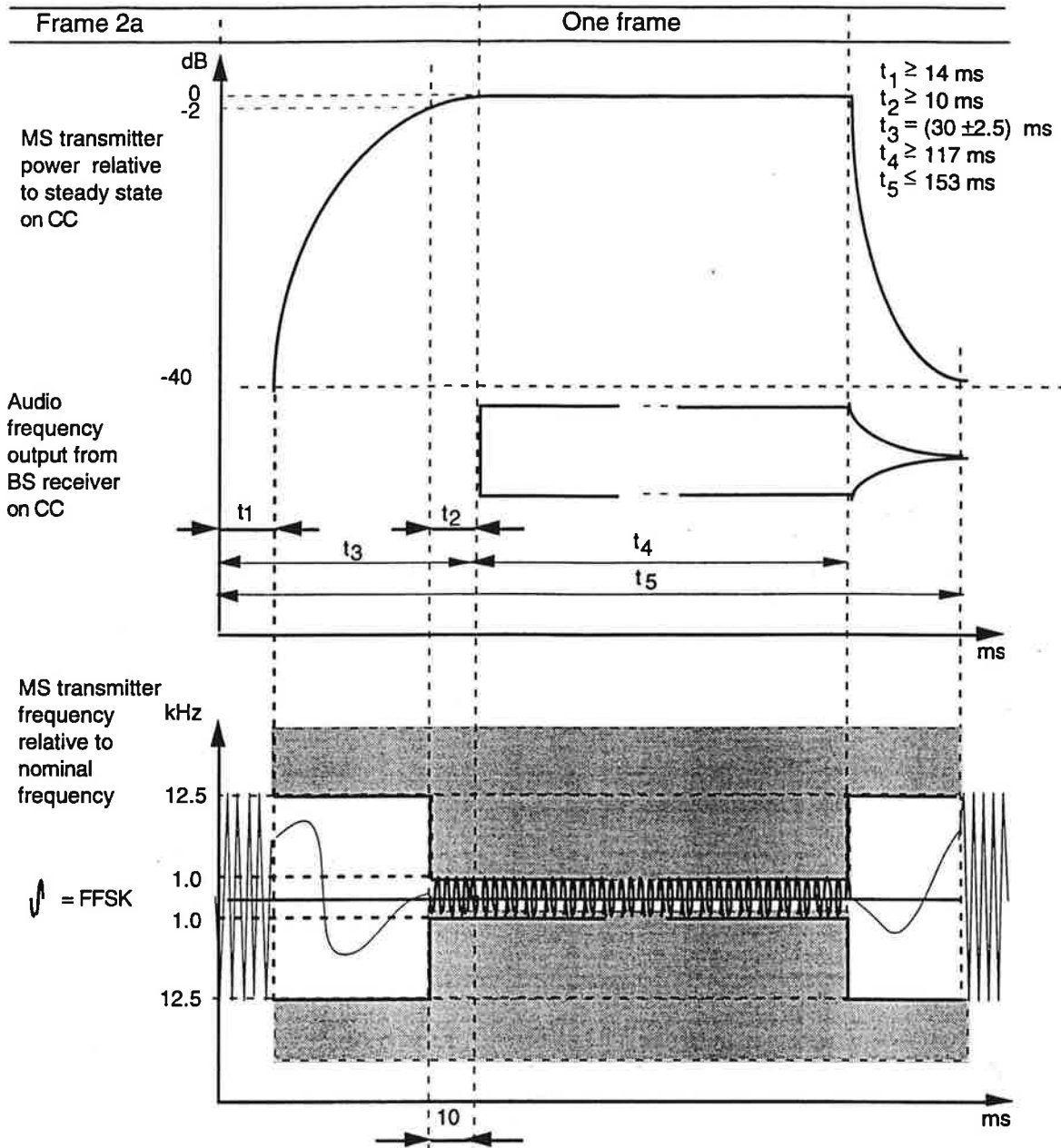

Fig. 6.3 Transmitter frequency transient behaviour, start up and decay times

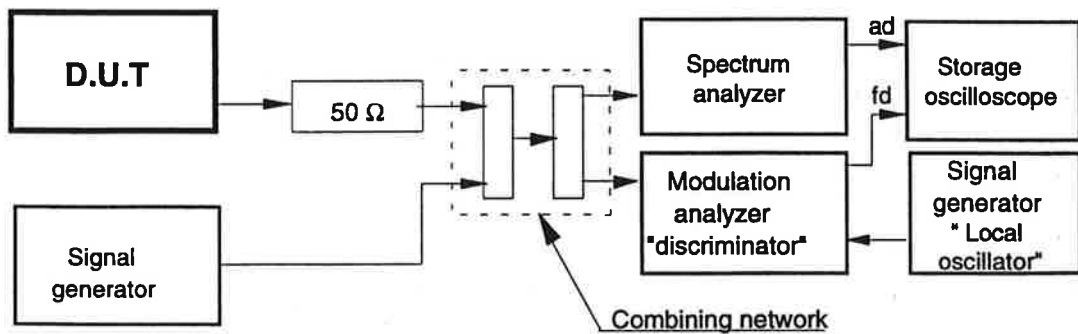

Fig. 6.4 Measurement arrangement

6.3 ACCEPTANCE OF SIGNALS

6.3.1 Errors are placed in the frames on the positions which should not be checked according to NMT Doc 450-1, and acceptance of the frames according to the signalling schemes are checked.

6.3.2 Burst errors are placed in the frames on the positions which shall be checked according to NMT Doc 450-1, paragraph 4.7, and acceptance/rejection of the frames according to the signalling schemes are checked.

The tests are performed at high signal levels in order to control where the errors are placed.

6.4 FUNCTIONAL TEST

Functional testing of the MS consists of a number of exercises. These exercises are carried out in order to test the operation of the logic in the MS. All the tests are carried out at various RF-signal levels and shall be successfully completed under normal and extreme conditions.

ANNEX 1

GENERAL INFORMATION CONCERNING TESTS, TYPE APPROVAL AND MARKING OF MOBILE EQUIPMENT TO BE USED IN THE NORDIC MOBILE TELEPHONE SYSTEM (NMT-450)

National deviations from this document may occur due to differences in legislation.

In connection with tests and type approval of mobile equipment to be used in the NMT 450 system, manufacturers/agents have to notice the following:

1. APPLICATION FOR TESTING

Equipment to be used in the NMT-450 system shall be tested in accordance with NMT Doc 450-3, "Technical specification for the mobile station", for type approval by the type approval authority/**accredited test laboratory** in one of the nordic countries (Denmark, Finland, Norway, Sweden). An application for testing shall be made in writing to the type approval authority/ accredited test laboratory.

The application for testing shall contain information about the make and type designation of the equipment and shall be accompanied by a complete technical description of the equipment, containing e.g. circuit diagrams, flow charts, PCB layouts and lists of components. Furthermore, it shall be informed if the particular type designation has previously been used in connection with type approval procedure in a Nordic country.

the **type approval authority/accredited test laboratory**.

It shall be comprising the manufacturer results obtained from measurements in accordance with the equipment specification. The report shall clearly state any deviation from the methods of measurement in the said document. The test laboratory shall then decide whether the test report is acceptable.

All documents presented with the type test application shall be the property of the type approval authority/**accredited test laboratory** and may be distributed to the other cooperating administrations. The applicant shall nominate one, or maximum two, person(s) to whom technical queries about the equipment can be addressed.

2. SELECTION OF EQUIPMENT FOR TESTING

Normally, the manufacturer shall present a specimen chosen from the production series for the testing. If the type approval is granted on the basis of tests made on a prototype, the corresponding production equipment shall in any relevant respect be identical with the specimen tested.

3. APPROVAL

All equipment of an approved type shall fulfil the specifications in NMT Doc 450-3. It shall be a condition of a type approval that all equipment made of the type are identical with the specimen tested, as regards circuit diagrams, components, software and assembling.

Equipment which are not electronically and mechanically identical, must not have the same designation. If modifications are made, a new type designation must be given. This will require a new approval if the modifications have any relation to the specifications in force. The type approval authority shall determine at their discretion whether types of equipment are identical in accordance with the above or whether new approval is necessary.

It shall be a condition for the continuing validity of a type approval that, for the purpose of control tests, a type approval authority may at any time freely select specimens of the type of equipment in question from the stock of the manufacturer/agent, and importer/dealer. In the event that through this, or in some other way, it is ascertained that the type of equipment does not fulfil the specifications in NMT Doc 450-3 or, if otherwise, the conditions of the approval have been disregarded, the approval may be cancelled both for equipment which have already been put into use and for equipment of the type in question which has not yet been put into use.

The approval shall solely cover conditions which bear upon the regulations laid down by the Nordic Telecommunications **authorities** and does not aim at covering the possible requirements of other authorities in respect of the stations and their installation in general.

4. MARKING OF THE EQUIPMENT

4.1 TYPE MARKING

The equipment shall be clearly marked with the make, type designation and serial number. This rule shall also apply to the sample which is handed in for testing. The marking shall be placed in such a manner on the equipment that it is easy to inspect when the equipment is mounted as specified by the manufacturer.

In case type approved equipment is modified after the manufacturing, the original type designation shall be unchanged. When such equipment is modified there are three alternatives:

1. Either use of an extra type designation plate with an addition to the original type designation. This plate must be placed near the original type designation.
2. Or use of original type designation plate and make an addition in such a way that original type designation remains unchanged. This addition shall not cover the previous information.
3. Or use of a new plate with the original marking + addition.

The marking shall be mechanically firm and durable and may, for example, be made by means of engraving, embossing or application of a metal plate. Using any kind of pens is not allowed.

The area including the required information (make, type designation and serial number) shall be very clearly distinguished from all additional information, if any, so that this additional information will not be mixed with the required information when a new NMT subscriber fills in the license application.

The word "SIS" shall be included on the type designation plate. The SIS marking shall be placed in a separate field. (See examples below!)

The type designation shall not include any non valid characters which are intended to come into use later at a possible type modification.

Before bringing the equipment on the market the marking must be approved by the type approval authority.

To make it easy to distinguish between type and serial number, it is required that this information is presented in the marking area in following order, starting from the top of the plate:

- make as such
- text "TYPE:" in front of the type designation. It may be followed by an empty area for future type modification changes i.e. new versions.
- text "SER NO:" in front of the serial number

If it is necessary from the manufacturer's point of view to include some additional information to this type marking, it is required to add such information outside the area with required information:

If type approval number is added to the type designation plate or elsewhere on the mobile, it shall be marked according to CEPT Rec. T/SF 47 E.

An example of a type marking which will be accepted straight away are shown below:

MAKE A/S	SIS
Type: ABCD 450 <input type="text"/>	DK93NMT678
Ser. no: <input type="text" value="12345"/>	

MAKE A/S
Type: ABCD 450 <input type="text"/>
Ser. no: <input type="text" value="12345"/>
SIS
FI 93 NMT678 Made in Finland

4.2 Program marking

The program shall have a marking, which can easily be checked. The marking may be on the program module itself or it may be shown on the dialled digit display under shift mode. Any changes in the program shall always result in a new program marking, and consequently, a new type marking

5. TYPE APPROVAL IN MORE THAN ONE NORDIC OR COOPERATING COUNTRY

When type approval is granted in one of the Nordic or cooperating (called gateway) countries, type approval in another cooperating country may be obtained by the following procedure.

The agent in the country for which type approval is sought, shall apply in writing to the type approval authority for type approval. Enclosed with the application shall be a copy of the type approval certificate & test report from the gateway type approval authority/accredited test laboratory. The Manufacturer/ Agent shall confirm in writing that the equipment for which type approval is sought, is in every respect identical with the equipment already type approved by the other authority.

The type approval authority shall decide whether an approval will be based on this documentation or if a new test will be required.

ANNEX 2

PORTABLE MOBILE STATION

A DEFINITION

A portable mobile station is a portable or transportable ordinary mobile equipment, powered from its own power source contained in the equipment.

The portable mobile station shall be designed in such a way that it can be used with an antenna mounted on the equipment.

A portable mobile station is classified as an ordinary mobile station when the portable mobile station is capable of being fully powered from an external power source at high transmitter output power level (15 W or optional 7 W), and the portable mobile station is connected to a power source capable of supplying sufficient power, e.g. power supply of a motor vehicle. In this case, the transmitter output power shall be fully controlled by the signalling to the mobile station from the base station.

B TECHNICAL REQUIREMENTS

The portable mobile stations shall fulfil the requirements in NMT Doc 450-3, with the following changes and additional requirements:

1.3.10 Vibration test

The portable MS shall be vibrated together with its own power source and antenna.

2.2 TRANSMITTER

2.2.4 Transmitter carrier power

The available steady-state carrier power output at the antenna terminal into an artificial antenna from the portable mobile station may be limited to the medium power level (1.5 W). The portable mobile station may be equipped with means for manual selection between high or medium power level (15/7 W or 1.5 W) as the maximum power from the portable mobile station. However, this manual selection must only be possible when the portable MS is in standby or off condition.

The tests are made with fully charged batteries. If the portable mobile station has restrictions regarding the operation time, these restrictions must be considered.

2.2.8 Spurious emissions

2.2.8.3 Method of measuring the effective radiated power

During the measurement of "effective radiated power", the antenna shall be connected.

The MS handset shall be placed in the cradle.

2.3 RECEIVER

2.3.14 Spurious emissions

2.3.14.3 Method of measuring the effective radiated power

During the measurement of "effective radiated power" the antenna shall be connected.

3.4 "Hands-Free" operation

"Hands-Free" operation need not be foreseen. In case "Hands-Free" facilities are provided, all the requirements in paragraph 3.4 shall be fulfilled.

5.2.1.3 Conversation

If the power source of the MS is about to run out of energy the user shall be warned. If the power source is not changed and its voltage reaches its lowest possible value clearing shall be transmitted and the power shall be switched off.

5.7.1.3 Additional autonomous power control in MS (optional)

If the received power bits from MTX are 10 (medium power) and if the mean RF level received in MS during conversation is above 30 dB (μ V) E.M.F. \pm 5 dB (but below 55 dB (μ V) E.M.F.) for 5 seconds, the RF output power shall be reduced to 500 mW \pm 2 dB. In the signalling towards MTX, however, the received power bits from MTX shall be used.

When the received mean RF level during conversation decreases to below 20 dB (μ V) E.M.F. \pm 5 dB for 5 seconds, the RF output level shall be increased to the maximum RF output power indicated by the MTX signalling. The hysteresis shall be at least 8 dB.

6.4 Functional test

The functional tests are carried out on the test site mentioned in paragraph 1.3.11 at various RF levels.

C ADDITIONAL TECHNICAL REQUIREMENTS

1. Antenna-efficiency, transmitter

When measuring the effective radiated power the test site mentioned in paragraph 1.3.11 shall be used.

The portable station with its antenna shall be rotated in the horizontal plane 0-360° and the height of the test antenna shall be varied in the range 1 to 4 m to obtain the maximum level on the test receiver. The test antenna shall be vertically polarized.

The effective radiated power P_r is determined by substitution measurement.

With the test antenna in the position giving maximum level on the test receiver, the portable station shall be rotated 0-360° in the horizontal plane and the level on the test receiver recorded.

Requirement: P_r shall in the maximum direction not be less than 3 dB below the power measured in an artificial antenna. The maximum/minimum ratio in the horizontal plane shall not be more than 6 dB.

2. Receiver duplex sensitivity degradation.

2.1 Definition

See paragraph 2.3.7.2

When measuring the receiver part of the portable station the test site mentioned in paragraph 1.3.11 or anechoic room (specified in standard ETS 300 086) suitable for that frequency shall be used.

2.2 Method of measurement

The portable station with its antenna and the test antenna shall be in the position giving maximum level on the test receiver, see paragraph 1 above.

The MS shall be in the condition of receiving ringing order. The reference field strength, E_0 , is the lowest level when the MS generates ringing locally as a response of frame 5a ($L=9$) with 95% reception probability. The level E_0 shall be noted.

The MS shall then be in the speech condition and the lowest field strength for a successful switching call in progress, E_S , shall be noted. The level E_S is the lowest signal level for which switching call in progress is successful with 95% probability during speech condition. The difference, $E_S - E_0$, in dB is a measure of the receiver duplex sensitivity degradation.

2.3 Method of measurement, alternative

The portable station with its antenna and the test antenna shall be in the position giving maximum level on the test receiver, see paragraph 1 above.

The MS shall be in the condition of receiving (transmitter off). The reference field strength, E_0 , is the lowest level when the SINAD(P)-ratio measured from the MS voice output circuit is 20 dB (see paragraph 2.3.7.1.1 and 2.3.7.1.2). The level E_0 shall be noted.

The MS shall then be in the speech condition (transmitter on) and the lowest field strength, E_S , for the 20 dB SINAD(P)-ratio shall be noted. The difference, $E_S - E_0$, in dB is a measure of the receiver duplex sensitivity degradation.

2.4 Requirements

The receiver duplex sensitivity degradation shall not exceed 3 dB for all transmitter output levels.

3. **Sound reproduction**

Sound reproduction is tested using the same radio frequency level from the system simulator as in the functional testing. The portable mobile station shall be in conversation mode. The microtelephone must be carried around in the hemisphere not containing the antenna and is limited by a plane having the microtelephone cable lead-through in the case. This plane shall have maximum distance from and be parallel with another plane containing the antenna axis. No oscillation or peeps should interfere with the speech. In the same way the transmitter is tested against the system simulator reference receiver or a deviation meter. When changing the position of the microtelephone the field strength to the portable mobile station is changed leading to noise in the telephone in some positions of the microtelephone. This should be distinguished from interference the transmitter itself may cause. Before this test is finished, it shall also be checked that the Operational Controls Unit is functioning properly (no malfunctions due to radiation).

Note:

See also ANNEX 12:HANDHELD MOBILE STATION WITH BATTERY SAVING FUNCTION

ANNEX 3

HANDHELD MOBILE STATION (HMS)

A DEFINITION

Handheld mobile station (HMS) is defined as a single easily carried unit containing its own power source, acoustic transducers, visual display, operating controls and antenna. The weight of handheld mobile station shall not exceed 1 kg. Mobile stations having greater weight than 1 kg are classified as portable mobile stations, see Annex 2.

B TECHNICAL REQUIREMENTS

Handheld mobile stations (HMS) shall fulfil the requirements for an ordinary mobile station with the following exceptions and additional requirements.

1.3.3 Test of the equipment

1.3.10 Vibration test

If the HMS is designed for car installation the holder shall be fixed to the mounting table.

During the vibration test of HMS the battery and antenna shall be mounted.

1.3.10.1 b) Microphony test

If the HMS is not designed for car installation no microphony test shall be done.

1.3.10.2 b) Functional test

If the HMS is not designed for car installation no microphony tests shall be done.

2.2 TRANSMITTER

2.2.4 Transmitter carrier power

The available steady-state carrier output power at the antenna terminal shall be $1.5 \text{ W} \pm 2 \text{ dB}$.

2.2.5 Transmitter carrier control

The transmitter shall be capable of changing the transmitter carrier output power as controlled by the Logic and Control Unit to $-10 \text{ dB} \pm 3 \text{ dB}$ (low power) relative to nominal carrier output power 1.5 W (high and medium power) at normal and extreme test conditions. However, at any test condition the carrier output power shall not deviate more than 3 dB between any arbitrary radio channel.

Power level	Power bits in N1 (Na)	HMS
High power	11	PH=1.5W \pm 2 dB
Medium power	10	PM=1.5W \pm 2 dB
Low power	01	PL=1.5W - (10 \pm 3dB)
Low power	00	PL=1.5W - (10 \pm 3dB)

2.2.8 Spurious emissions

2.2.8.3 Method of measuring the effective radiated power

During the measurement of "effective radiated power" the antenna shall be connected.

2.3 RECEIVER

2.3.7.1 RF-sensitivity

The maximum RF signal level difference between any arbitrary channels to get the same SINAD(P)-ratio shall not exceed 3 dB at any test condition.

2.3.9 Adjacent channel selectivity

The adjacent channel selectivity shall not be less than 67 dB under normal test conditions and 60 dB under extreme test conditions.

2.3.11 Spurious response rejection

The spurious response rejection shall be at least 67 dB.

2.3.14 Spurious emissions

2.3.14.3 Method of measuring the effective radiated power

During the measurement of "effective radiated power" the antenna shall be connected.

2.4 Ø-SIGNAL LOOP AND TRANSCEIVER COUPLING

2.4.3 Interference in the Ø-signal frequency band

The interference level in the looped Ø-signal channel shall not exceed in case a) -5 dB and in case b) -10 dB relative to the Ø-signal level.

2.4.4 Relative frequency intermodulation product level in the Ø-signal band

The intermodulation product level in the looped Ø-signal channel shall not exceed -5 dB relative to the Ø-signal level.

3.3 HANDSET

The HMS is a single unit with integrated handset function.

3.4 "HANDS-FREE" OPERATION

"Hands-Free" operation need not to be foreseen. In case "Hands-Free" facilities are provided, all the requirements in paragraph 3.4 shall be fulfilled.

5.2 DESCRIPTION OF LCU ACTIVITIES

5.2.1.3 Conversation

If the power source of the HMS is about to run out of energy the user shall be warned. If the power source is not changed and its voltage reaches its lowest possible value clearing shall be transmitted and the power shall be switched off.

5.7.1.3 Additional autonomous power control in MS (optional)

If the received power bits from MTX are 10 (medium power) and if the mean RF level received in MS during conversation is above 30 dB (μV) E.M.F. ± 5 dB (but below 55 dB (μV) E.M.F.) for 5 seconds, the RF output power shall be reduced to 500 mW ± 2 dB. In the signalling towards MTX, however, the received power bits from MTX shall be used.

When the received mean RF level during conversation decreases to below 20 dB (μV) E.M.F. ± 5 dB for 5 seconds, the RF output level shall be increased to the maximum RF output power indicated by the MTX signalling. The hysteresis shall be at least 8 dB.

6.4 FUNCTIONAL TESTS

The functional tests are carried out on the test site mentioned in paragraph 1.3.11 at various RF signal levels.

C ADDITIONAL TECHNICAL REQUIREMENTS

1. Antenna efficiency, transmitter

When measuring the effective radiated power the test site mentioned in paragraph 1.3.11 shall be used.

The HMS with its antenna shall be rotated in the horizontal plane 0-360° and the height of the test antenna shall be varied in the range from 1 to 4 m to obtain the maximum level on the test receiver. The test antenna shall be vertically polarized.

The effective radiated power P_r is determined by substitution measurement.

With the test antenna in the position giving maximum level on the test receiver, the handheld mobile station shall be rotated 0-360° in the horizontal plane and the level on the test receiver recorded.

Requirement: P_r shall in the maximum direction not be less than 3 dB below the power measured in an artificial antenna. The maximum / minimum ratio in the horizontal plane shall not be more than 6 dB.

2. Receiver duplex sensitivity degradation.

2.1 Definition

See paragraph 2.3.7.2

When measuring the receiver part of the portable station the test site mentioned in paragraph 1.3.11 or anechoic room (specified in standard ETS 300 086) suitable for that frequency shall be used.

2.2 Method of measurement

The portable station with its antenna and the test antenna shall be in the position giving maximum level on the test receiver, see paragraph 1 above.

The MS shall be in the condition of receiving ringing order. The reference field strength, E_0 , is the lowest level when the MS generates ringing locally as a response of frame 5a (L=9) with 95% reception probability. The level E_0 shall be noted.

The MS shall then be in the speech condition and the lowest field strength for a successful switching call in progress, E_S , shall be noted. The level E_S is the lowest signal level for which switching call in progress is successful with 95% probability during speech condition. The difference, $E_S - E_0$, in dB is a measure of the receiver duplex sensitivity degradation.

2.3 Method of measurement, alternative

The portable station with its antenna and the test antenna shall be in the position giving maximum level on the test receiver, see paragraph 1 above.

The MS shall be in the condition of receiving (transmitter off). The reference field strength, E_0 , is the lowest level when the SINAD(P)-ratio measured from the MS voice output circuit is 20 dB (see paragraph 2.3.7.1.1 and 2.3.7.1.2). The level E_0 shall be noted.

The MS shall then be in the speech condition (transmitter on) and the lowest field strength, E_S , for the 20 dB SINAD(P)-ratio shall be noted. The difference, $E_S - E_0$, in dB is a measure of the receiver duplex sensitivity degradation.

2.4**Requirements**

The receiver duplex sensitivity degradation shall not exceed 3 dB for all transmitter output levels.

3.**Use of HMS in vehicles**

The HMS may be connected to an external antenna, external handset and the power source of the vehicle. In case it is not possible to use the operational and control buttons when the HMS is connected, another operational and control unit shall be used. The built-in batteries may be charged from the power source. When the HMS is connected to external antenna, handset or operational and control unit, the corresponding devices in the HMS shall be made inoperable.

Auxiliaries to HMS which makes it possible or easier to use the equipment in vehicles are called "car mounting kit" in the following text.

The combination of HMS and its car mounting kit shall fulfil the specifications given in NMT Doc 450-3 and Annex 3. The antenna terminal of the mounting kit towards the car antenna (corresponds to antenna interface E in Annex 18) is used as antenna terminal for measurements when testing a car mounting kit.

Note:

See also ANNEX 12:HANDHELD MOBILE STATION WITH BATTERY SAVING FUNCTION

ANNEX 4

SPECIFICATION FOR PRIORITY MOBILE STATION (PMS)

1. General

In order to give certain mobile subscribers better access to the system than ordinary mobile subscribers during busy hours, their mobile stations are provided with a priority function, giving them the possibility to be put in a priority queue for the next free marked TC. This facility is of particular importance when all traffic channels on a base station are occupied.

[In emergency situations the MTX may reserve a number of traffic channels per basestation for priority traffic. These channels can then be accessed by the PMS by using the PMS signalling scheme.]

The signalling procedures are described in addendum to NMT Doc 450-1, paragraph 4.4.1.7.

The PMS is given priority only for outgoing calls, i.e. calls *to* a PMS are not affected. Priority does not imply the interruption of other established calls, and is only effective on the radio path.

To be able to make a priority call the MS has to be provided with a dedicated priority button. Alternatively a sequence of buttons may be pushed to activate the priority function. The term "priority button" in the NMT-specifications is valid also for the sequence alternative.

The MS shall be provided with a visual priority indicator.

Normally the subscriber with priority possibility will establish calls as an ordinary subscriber, i.e. without activating the priority button.

The PMS shall in all aspects act as a normal MS when the priority indicator is switched off.

2. Initiation of priority calls

If a mobile subscriber with priority wishes to use the priority facility, the priority button is activated in "on hook" condition after the desired number has been dialled and stored in dialled digits memory. The priority indicator is switched on. (The off hook function shall not be used at this moment.)

If the PMS goes "off hook" after the priority button is activated, but before a TC is assigned, the priority indicator shall be switched off and a normal call shall be performed. [The PMS is then taken away from the priority queue.]

The user have the possibility to interrupt the priority call set up, until address complete frame 5a(L=6) is received, by pressing the priority button once again. If the PMS is locked to a TC, clearing shall be transmitted. Otherwise it shall go to state Search for CC.

If the PMS receives forced release or if an autonomous time-out occurs the priority indicator shall be switched off and malfunction alarm shall be activated.

2.1 Call initiation on CC

When a priority call is initiated, the MS has to wait until the CC is "free", i.e. one frame 1a, 2b, 2c, 2d or 2f shall be received T" before seizure signal frame 11b is sent on CC. [The MTX receives the call, and checks the MS category (priority).] If the CC is not "free" within 5 seconds after the priority button has been pushed, the PMS shall send its seizure T" after any frame on the CC.

Possible incoming calls to the PMS shall be ignored.

2.2 Call initiation on combined CC/TC

If the user initiates a priority call while the PMS is locked to a combined CC/TC, the PMS shall locally generate a ringing signal. A normal call shall be set up when the user has initiated "off hook". The priority indicator shall be switched off after reception of address complete, frame 5a(L=6).

If the CC/TC is gone when the call is to be set up the priority indicator shall be switched off.

2.3 No CC or combined CC/TC available

If the PMS is *not* locked to a CC or CC/TC when a priority call is initiated the malfunction alarm shall be activated. The dialled digits display and memory shall not be cleared.

3. Call set up procedures

If the MTX can assign an idle TC on this BS at once, a channel order frame 2b is given on CC. After identity checks on the TC, ringing order is sent from the MTX, which expects an answer. When the subscriber puts the PMS in "off hook" condition the call is set up in the same way as a call from an ordinary MS.

If no idle TC is available on this BS, the PMS is placed in a priority queue in the MTX. This is indicated by the PMS receiving frame 2c on the CC. If frame 2b or 2c is not received within T after transmission of frame 11b, the PMS shall initiate a second search for CC in order to make another priority call attempt. If also this second call attempt fails, the priority indicator shall be switched off and malfunction alarm shall be activated.

[The PMS remains in the queue in the MTX until a TC is assigned, but not longer than about 90 seconds. As long as priority mobile stations are queuing under a BS, no TC will be assigned for use by ordinary mobile stations.]

If the PMS has not received a call within 90 ± 1 seconds, the priority indicator shall be switched off and malfunction alarm shall be activated, informing the subscriber that a new call attempt has to be made.

When a TC is available the MTX calls the PMS in question in the same way as an ordinary call *to* a MS.

[If no acknowledge is received from the PMS within two call attempts, the PMS is taken out of the queue and the call is abandoned.]

If the PMS does not receive identity request, frame 3b, within T' after reception of frame 2b, the PMS shall go back to CC waiting for a second frame 2b. If the second frame 2b is not received within 2T the priority indicator shall be switched off and malfunction alarm shall be activated.

The PMS receives authentication request frames immediately after the first ringing order. When the subscriber answers the call, answer signal frame 13a(L=14) is sent towards the MTX, followed by the signed response frame 16. Then the procedure continues as a call *from* an ordinary MS. When the MS has received address complete, frame 5a(L=6), the priority indicator is switched off.

If MTX orders transmission of encoded digits, frame 5a(L=11), they are sent if the PMS has received authentication request. Otherwise the PMS shall transmit clearing, switch off the priority indicator and activate malfunction alarm.

If the PMS is also a BMS (Mobile Station with Battery Saving Function), it shall ignore the battery saving orders while the priority indicator is switched on.

4. Loss of locking to CC

If the PMS loses the locking to the CC while the priority indicator is on it shall start searching for a new CC. If during scanning the queue timer expires the priority indicator shall be switched off and malfunction alarm shall be activated.

4.1 CC found in the old TA

If the PMS locks to a new CC in the same TA with the priority indicator on, a priority call is initiated immediately and the PMS is cancelled from the queue in the former BS. If no idle TC is available on the new BS, the MS is placed in the priority queue for this BS. The queue-timers in the MTX and PMS are reset.

4.2 CC found in a new TA

If the PMS enters a new TA, i.e. state roaming flag set, the priority indicator shall be switched off and the PMS shall leave the priority state and enter the state "search for TC, roaming flag set". The user may then interrupt the roaming procedure by pressing the priority button. The PMS will in this case search for a CC and update its roaming position using the PMS signalling scheme. Hence the PMS shall accept frame 2c (or 2b) on the CC as a "roaming update confirmation".

P. Priority call

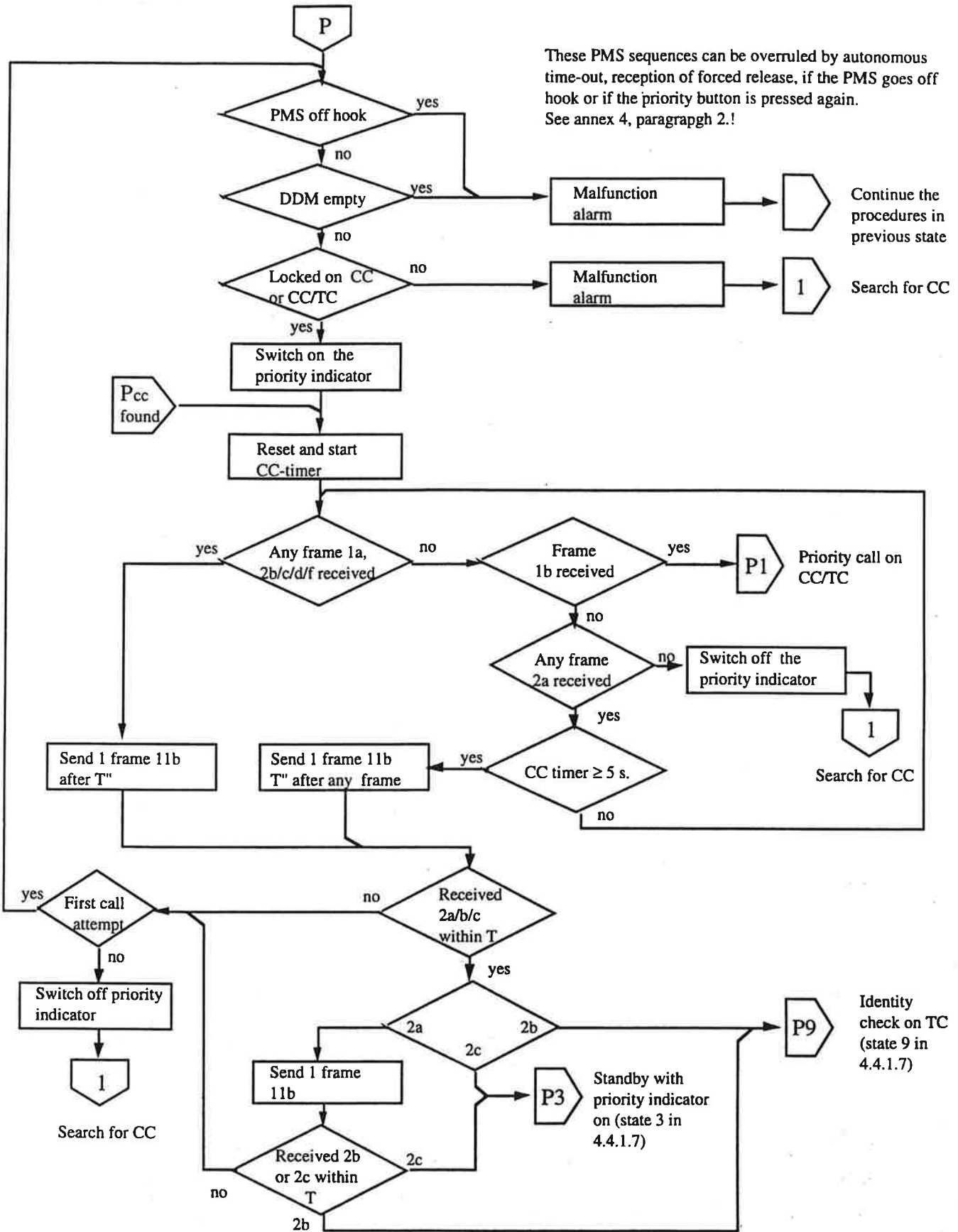

P1. Priority call on CC/TC

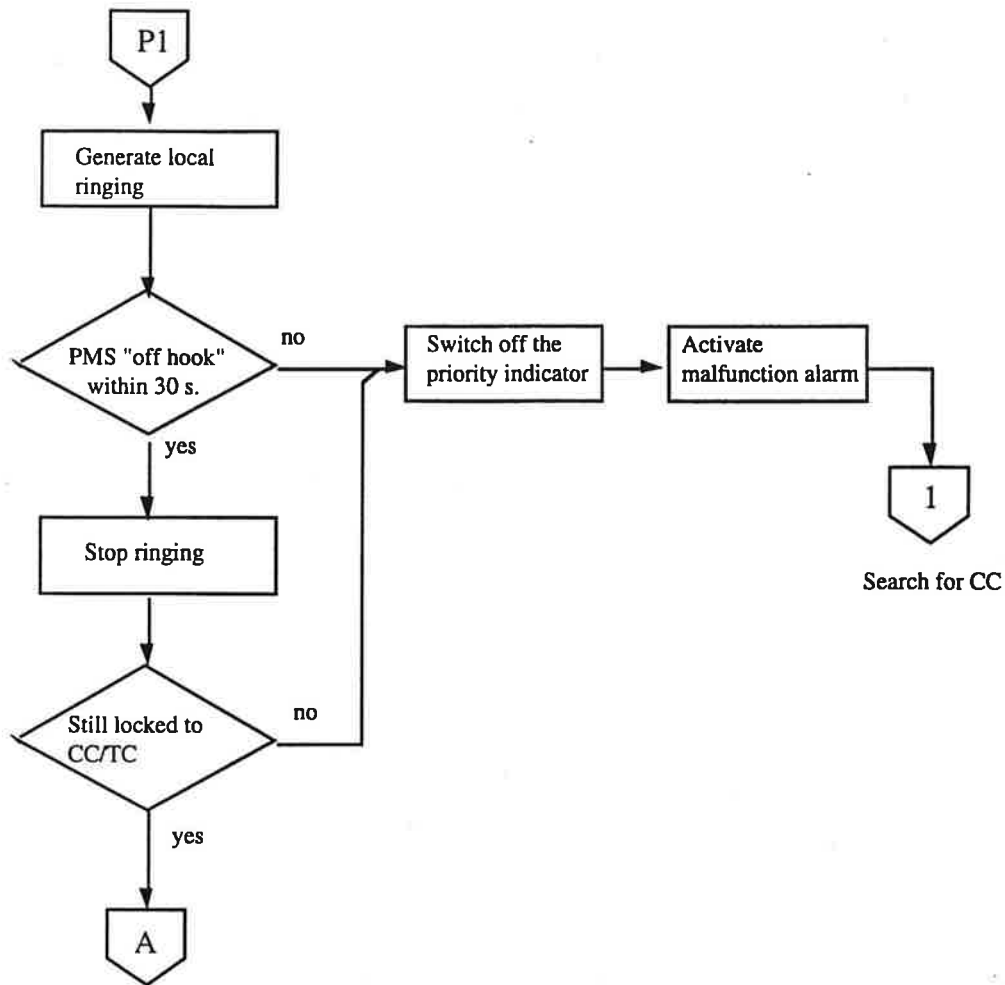

Go to Call MS->MTX

Switch off priority indicator after reception of 5a(L=6)

P3. Stand by with priority indicator on

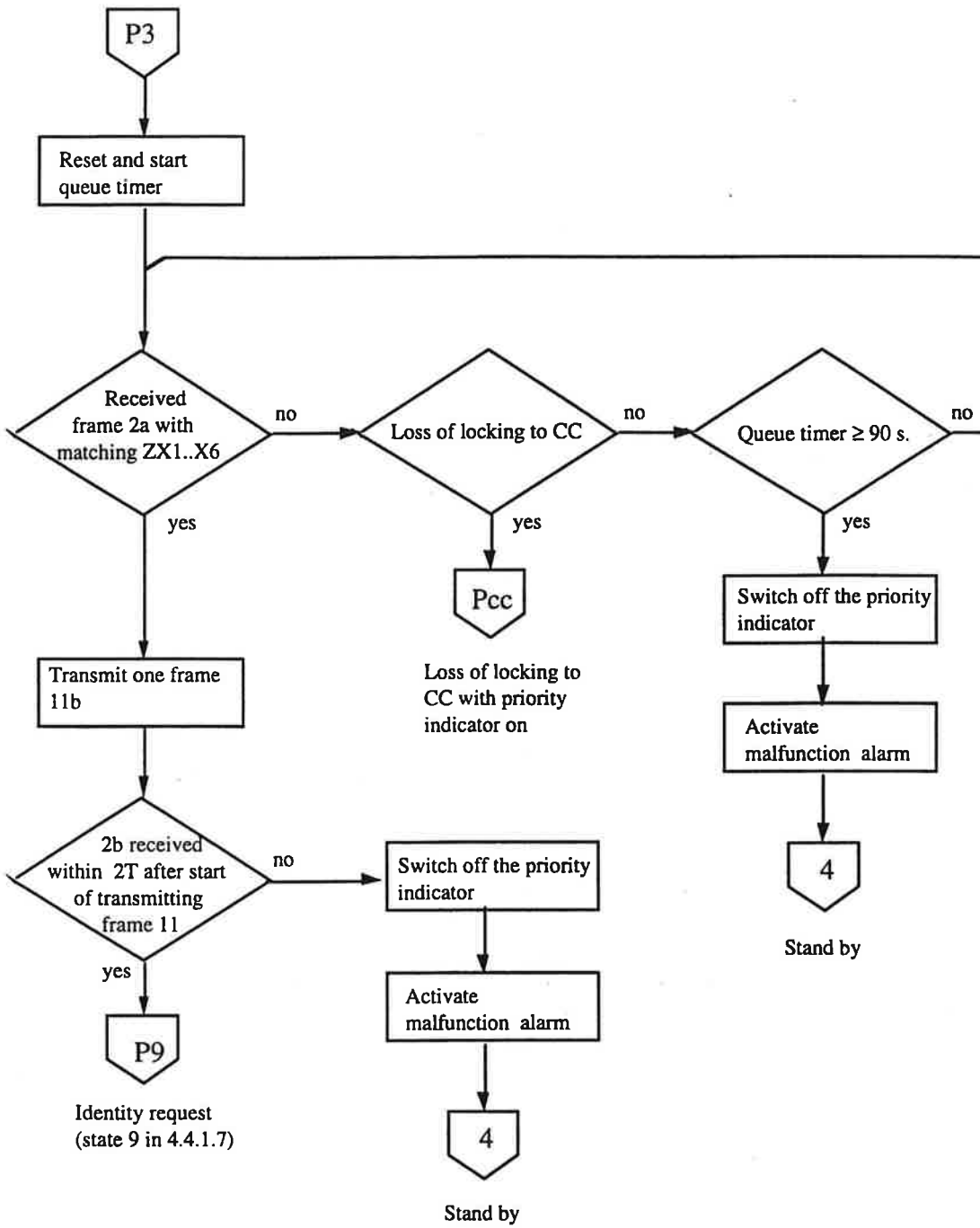

Pcc. Search for CC with priority indicator on

Additional requirements for the Pcc sequence:

This sequence is overruled also if the queue timer is exeded. The PMS shall then switch off the priority indicator, activate malfunction alarm and enter state 3, Search for CC.

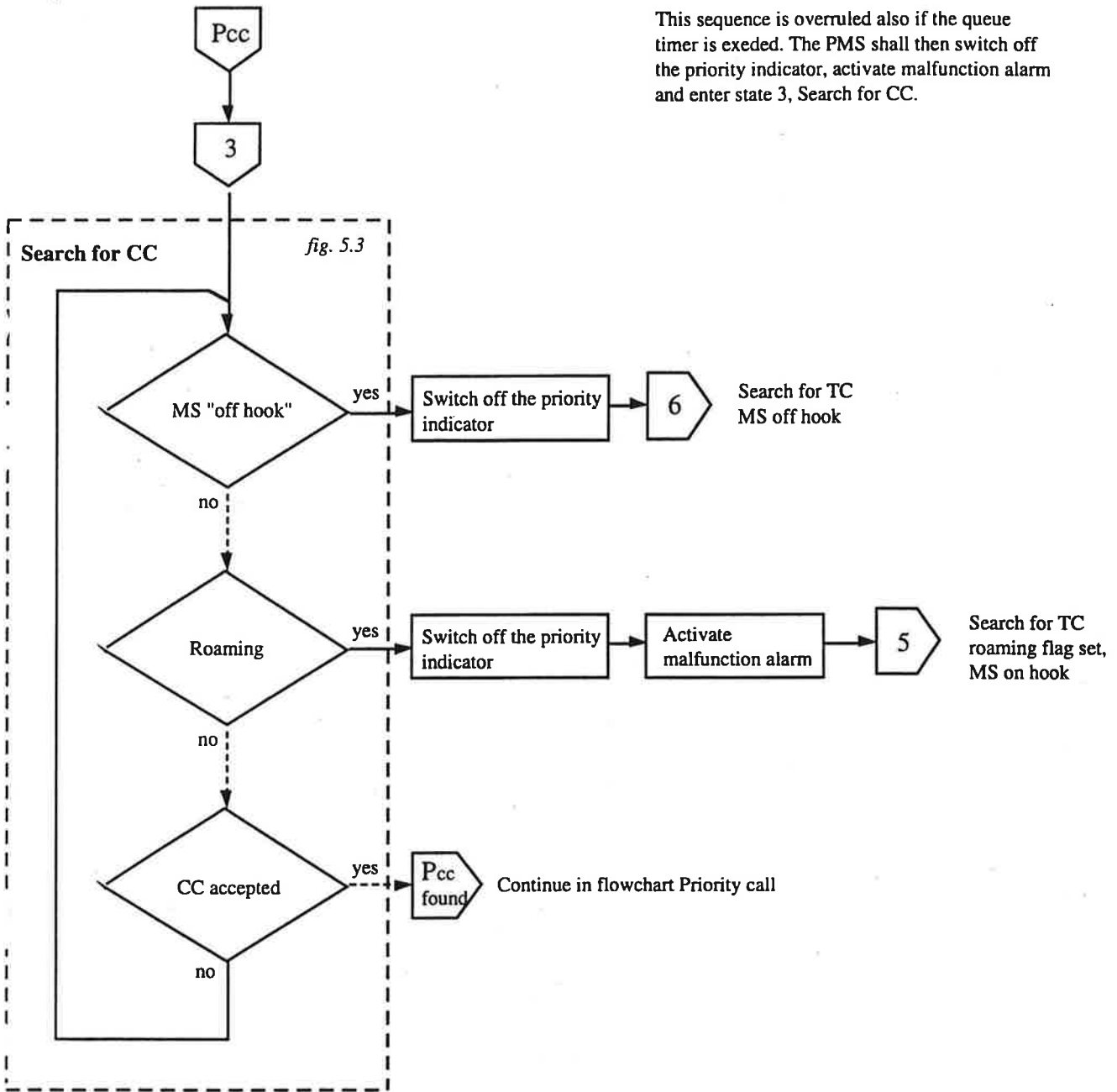

P9. Priority call, identity check

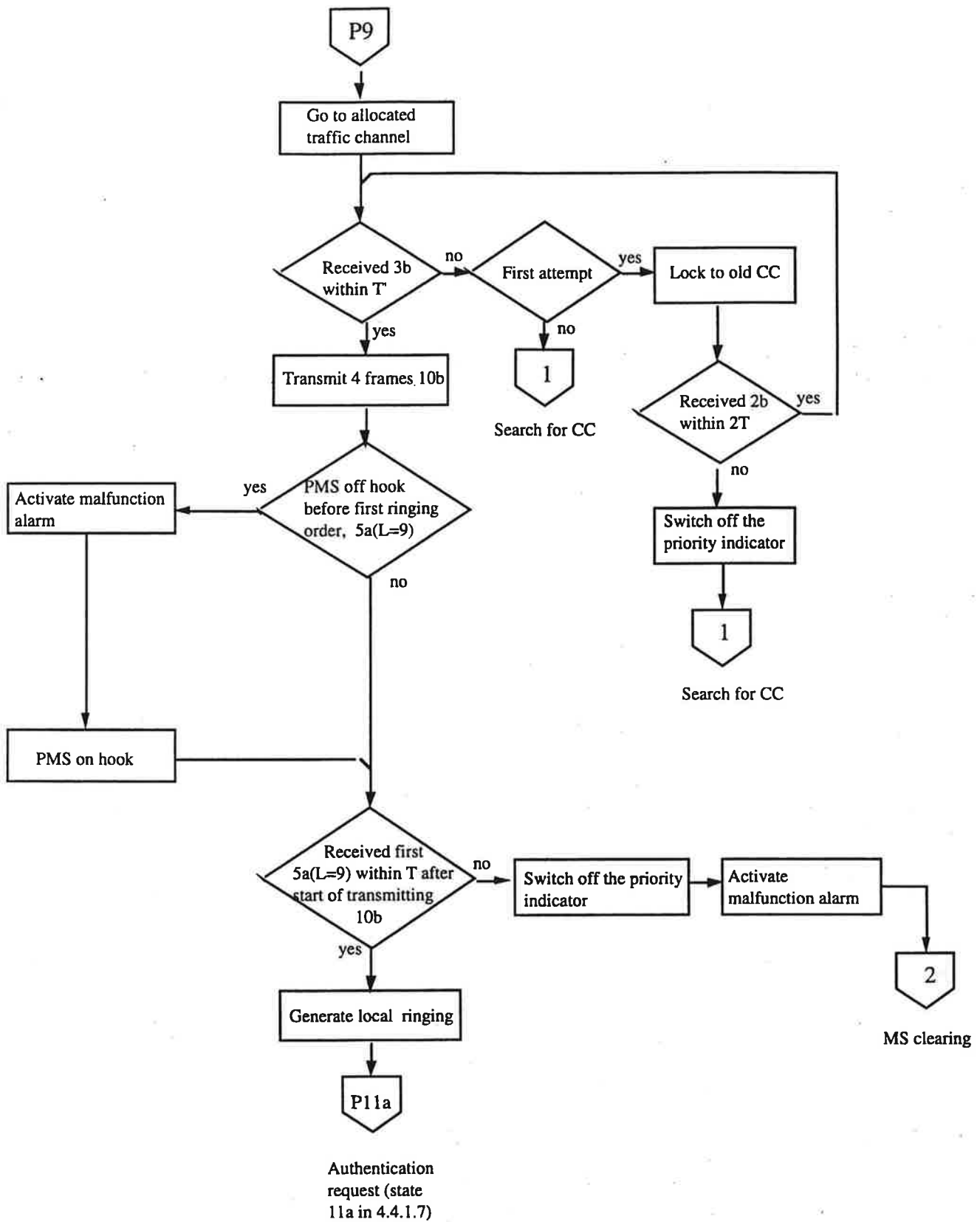

P11a. Priority call, authentication request

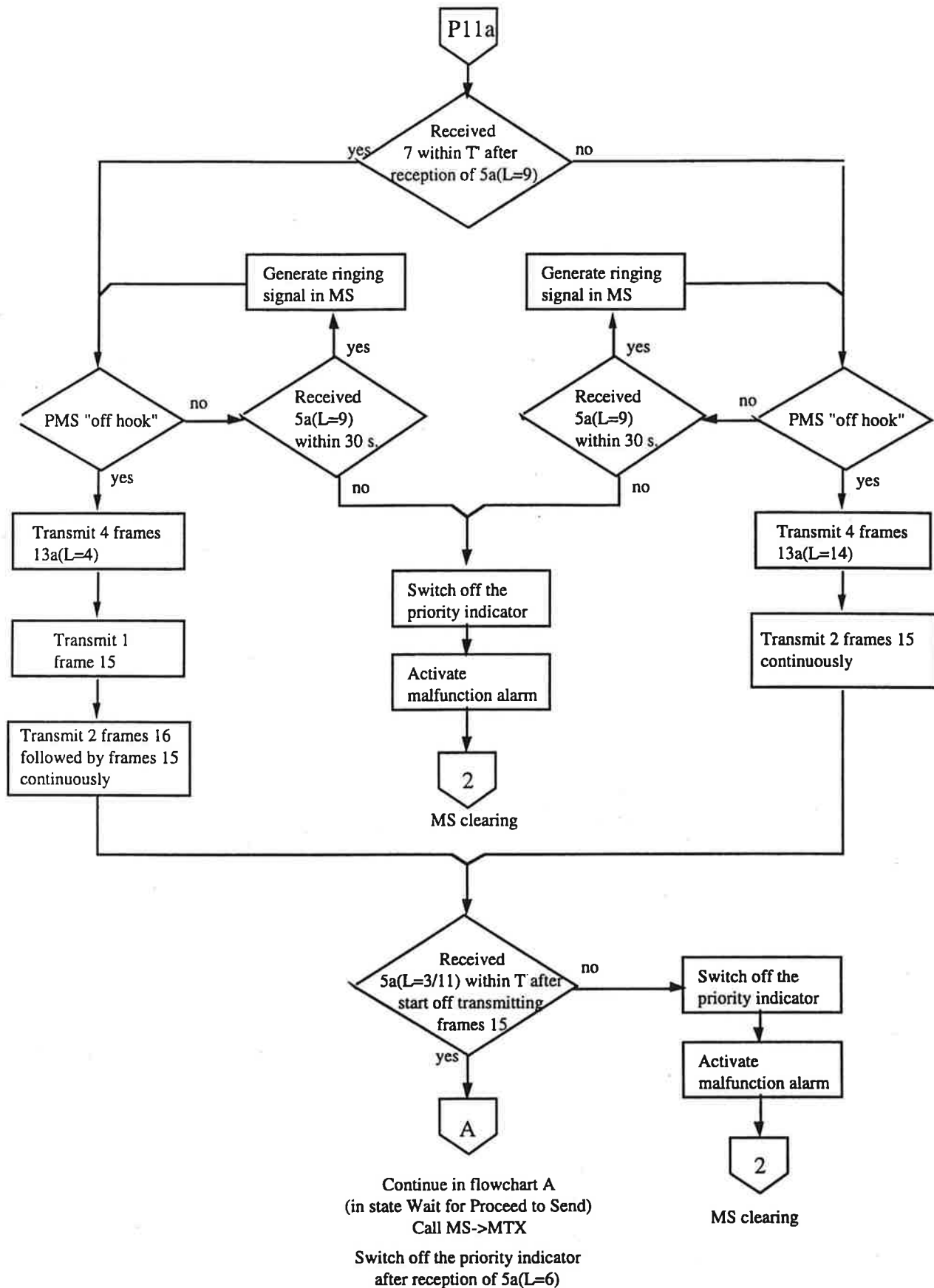

ANNEX 5

SPECIFICATION FOR MOBILE PAY-PHONES IN NMT-450 AND NMT-900

1. Definition

The complete specification for the NMT mobile pay-phone consists of the requirements stated in NMT Doc 450-1 and NMT Doc 450-3 for NMT-450, and NMT Doc 900-1 and NMT Doc 900-3 for NMT-900, including the respective Addenda, and the requirements set out in this document. The mobile pay-phone specified in this document shall use the specific "coin-box" signalling procedure for outgoing calls.

This specification states the requirements set for a mobile pay-phone from the NMT system point of view. The type approval authorities may also have additional national requirements for mobile pay-phones and may also define other types of mobile stations as mobile pay-phones.

2. Types of mobile pay-phones

Different types of mobile pay-phones are foreseen. They may be divided into two groups:

- Coin-box mobile stations where the user pays for the call in connection with the conversation, either by means of coins or a debit/credit card.
- Call-meter mobile stations where the user pays the owner on the basis of a counter (call-meter) in the MS which registers the costs of the calls.

The mobile pay-phone is marked in the mobile telephone exchange (MTX) with a coinbox category which includes the transfer of tariff information to the MS (NMT Doc 450-1 and NMT Doc 900-1, paragraph 4.4.1.6).

3. Charging information from MTX

Based on the dialled telephone number (or procedure) sent by the pay-phone MS, the MTX decides the charging rate for the actual call. This tariff information Q_1Q_2 is sent from the MTX to the mobile pay-phone when the charging is to start (frame 5b, "Answer to coinbox").

The tariff information indicates either a fixed rate (Table 1) or a time dependent rate (Table 2) for a special call, depending on the type of call (e.g. call to special services or long distance calls respectively).

The correspondence between the tariff information Q_1Q_2 received from the MTX and the actual charging rate is stored locally in the mobile pay-phone, and is given in Tables 1 and 2. Coding of the Q_1Q_2 values shall for both NMT-450 and NMT-900 be made in accordance with paragraph 4.3.3.1 in NMT Doc 900-1.

The *price* for the call must be calculated locally in the mobile pay-phone based on the received tariff information (Q_1Q_2 value).

The tariff information given by the MTX is not accurate, and may be up to 3 % above the actual charging rate for time-dependent rates. For calls with fixed rates the given tariff information is adjusted upwards.

The charging rate is given in the monetary unit of the actual country.

The meaning of the Q_1Q_2 values shown in Tables 1 and 2 may be changed in the future. It should therefore be easy to change the content in the tables.

4. Charging principles in different nordic countries

Due to different tariff structures in the different countries, the charging rate given to the mobile pay-phones will not always be 100 % correct. The call may e.g. be charged at a per minute rate from the operator, while the tariff information from MTX to the mobile pay-phone will indicate a per second rate.

The difference between the call charging by the operator and the tariff information given from the MTX to the mobile pay-phone must be taken into account by the owner of mobile pay-phones.

It should also be taken into account that the operator may charge an initial fee for every call from a mobile pay-phone. Information regarding such initial fee will not be given in the Q_1Q_2 information.

5. Type approval of mobile pay-phones

A mobile pay-phone must be type approved by the type approval authorities before entering the NMT system. The type approval will include both the functioning as a normal MS and those special facilities (signalling, handling of charging information etc.) which are connected with the pay-phone service.

The type approval will also include the interface between the MS and the connected equipment.

6. Additional national requirements

The type approval authorities may add further requirements to this specification and to the user interface.

TARIFF INFORMATION Q₁Q₂ TO NMT PAY-PHONES

Table 1

The tariff information Q₁Q₂ gives the *price per call* and the price is given in the local currency (DKK, FIM, NOK or SEK).

Table Q ₁ Q ₂ (with decimal presentation) (frame 5b, 13b)		
Q ₁ Q ₂	Currency	Note
00	---	not used
01	0,25	price/call
02	0,50	---
03	0,75	---
04	1,00	---
05	1,25	---
06	1,50	---
07	1,75	---
08	2,00	---
09	2,50	---
10	3,00	---
11	4,00	---
12	5,00	---
13	7,50	---
14	10,00	---
15	12,50	---
16	15,00	---
17	17,50	---
18	20,00	---
19	25,00	---
20	0,00	free

Table 2

The tariff information Q₁Q₂ gives the *price per second* and the price is given as 1/100 of the local currency (DKK, FIM, NOK or SEK).

Table Q ₁ Q ₂ (with decimal presentation) (frame 5b, 13b)					
Q ₁ Q ₂	Currency/100	Note	Q ₁ Q ₂	Currency/100	Note
21	0,500	price/sec	58	1,414	price/sec
22	0,515	- "-	59	1,456	- "-
23	0,530	- "-	60	1,498	- "-
24	0,545	- "-	61	1,542	- "-
25	0,561	- "-	62	1,587	- "-
26	0,578	- "-	63	1,634	- "-
27	0,595	- "-	64	1,682	- "-
28	0,612	- "-	65	1,731	- "-
29	0,630	- "-	66	1,782	- "-
30	0,648	- "-	67	1,834	- "-
31	0,667	- "-	68	-	not used
32	0,687	- "-	69	1,888	price/sec
33	0,707	- "-	70	1,943	- "-
34	0,728	- "-	71	2,000	- "-
35	0,749	- "-	72	2,059	- "-
36	0,771	- "-	73	2,119	- "-
37	0,794	- "-	74	2,181	- "-
38	0,817	- "-	75	2,245	- "-
39	0,841	- "-	76	2,311	- "-
40	0,866	- "-	77	2,378	- "-
41	0,891	- "-	78	2,448	- "-
42	0,917	- "-	79	2,520	- "-
43	0,944	- "-	80	2,594	- "-
44	0,972	- "-	81	2,670	- "-
45	1,000	- "-	82	2,748	- "-
46	1,029	- "-	83	2,828	- "-
47	1,059	- "-	84	2,911	- "-
48	1,091	- "-	85	2,997	- "-
49	1,122	- "-	86	3,084	- "-
50	1,155	- "-	87	3,175	- "-
51	-	not used	88	3,268	- "-
52	1,189	price/sec	89	3,364	- "-
53	1,224	- "-	90	3,462	- "-
54	1,260	- "-	91	3,564	- "-
55	1,297	- "-	92	3,668	- "-
56	1,335	- "-	93	3,776	- "-
57	1,374	- "-	94	3,886	- "-

Table Q ₁ Q ₂ (with decimal presentation) (frame 5b, 13b)					
Q ₁ Q ₂	Currency/100	Note	Q ₁ Q ₂	Currency/100	Note
95	4,000	price/sec	143	15,54	price/sec
96	4,117	- "-	144	16,00	- "-
97	4,238	- "-	145	16,47	- "-
98	4,362	- "-	146	16,95	- "-
99	4,490	- "-	147	17,45	- "-
100	4,622	- "-	148	17,96	- "-
101	4,757	- "-	149	18,49	- "-
102	-	not used	150	19,03	- "-
103	4,896	price/sec	151	19,59	- "-
104	5,040	- "-	152	20,16	- "-
105	5,187	- "-	153	-	not used
106	5,339	- "-	154	20,75	price/sec
107	5,496	- "-	155	21,36	- "-
108	5,657	- "-	156	21,98	- "-
109	5,823	- "-	157	22,63	- "-
110	5,993	- "-	158	23,29	- "-
111	6,169	- "-	159	23,97	- "-
112	6,350	- "-	160	24,68	- "-
113	6,536	- "-	161	25,40	- "-
114	6,727	- "-	162	26,14	- "-
115	6,924	- "-	163	26,91	- "-
116	7,127	- "-	164	27,70	- "-
117	7,336	- "-	165	28,51	- "-
118	7,551	- "-	166	29,35	- "-
119	7,772	- "-	167	30,21	- "-
120	8,000	- "-	168	31,09	- "-
121	8,235	- "-	169	32,00	- "-
122	8,476	- "-	170	-	not used
123	8,724	- "-	171	32,94	price/sec
124	8,980	- "-	172	33,90	- "-
125	9,243	- "-	173	34,90	- "-
126	9,514	- "-	174	35,92	- "-
127	9,793	- "-	175	36,97	- "-
128	10,08	- "-	176	38,06	- "-
129	10,37	- "-	177	39,17	- "-
130	10,68	- "-	178	40,32	- "-
131	10,99	- "-	179	41,50	- "-
132	11,31	- "-	180	42,72	- "-
133	11,65	- "-	181	43,97	- "-
134	11,99	- "-	182	45,26	- "-
135	12,34	- "-	183	46,58	- "-
136	12,70	- "-	184	47,95	- "-
137	13,07	- "-	185	49,35	- "-
138	13,45	- "-	186	50,80	- "-
139	13,85	- "-	187	52,29	- "-
140	14,25	- "-	188	53,82	- "-
141	14,67	- "-	189	55,40	- "-
142	15,10	- "-	190	57,02	- "-

Table Q ₁ Q ₂ (with decimal presentation) (frame 5b, 13b)					
Q ₁ Q ₂	Currency/100	Note	Q ₁ Q ₂	Currency/100	Note
191	58,69	price/sec	221	-	not used
192	60,41	- "-	222	139,6	price/sec
193	62,18	- "-	223	143,7	- "-
194	64,00	- "-	224	147,9	- "-
195	65,88	- "-	225	152,2	- "-
196	67,81	- "-	226	156,7	- "-
197	69,80	- "-	227	161,3	- "-
198	71,84	- "-	228	166,0	- "-
199	73,95	- "-	229	170,9	- "-
200	76,11	- "-	230	175,9	- "-
201	78,34	- "-	231	181,0	- "-
202	80,64	- "-	232	186,3	- "-
203	83,00	- "-	233	191,8	- "-
204	85,43	- "-	234	197,4	- "-
205	87,94	- "-	235	203,2	- "-
206	90,51	- "-	236	209,2	- "-
207	93,17	- "-	237	215,3	- "-
208	95,90	- "-	238	221,6	- "-
209	98,71	- "-	239	228,1	- "-
210	101,6	- "-	240	234,8	- "-
211	104,6	- "-	241	241,6	- "-
212	107,6	- "-	242	248,7	- "-
213	110,8	- "-	243	256,0	- "-
214	114,0	- "-	244	spare	
215	117,4	- "-	-	-	
216	120,8	- "-	-	-	
217	124,4	- "-	-	-	
218	128,0	- "-	254	spare	
219	131,8	- "-	255	-	not used
220	135,6	- "-			

Note 1: The notation "Not used" indicates that this Q₁Q₂ value never will be used to transfer tariff information, because frames with this content shall be handled as a normal line signal from the MTX.

Note 2; Currency value for (Q₁Q₂)_N = 1,0293025 x currency value for (Q₁Q₂)_{N-1}. Remember however "Not used" Q₁Q₂ values.

ANNEX 6

MOBILE STATION WITH MFT FUNCTION

Specification for data transmission from push-button set in MS *using the MFT function* (option)

1 Basic procedure

A mobile station equipment with MFT signalling facility shall be provided with an MFT converter IN/OUT functionality.

The activation of this function in conversation state shall initiate transmission of the signals "MFT converter IN/OUT". Furthermore a visual indicator in connection with the MFT function shall be provided, indicating that the MS is in MFT converter state.

A scrolling dialled digits display is mandatory.

Pressing a digit button in MFT converter state shall provide transmission of two consecutive digit frames (14a/b). The digit is immediately shown on the dialled digits display. MS shall accept and store several digits and transmit them in the chosen order.

Pressing a digit button continuously, must not cause the same digit to be retransmitted.

When the MFT converter state is abandoned, i.e. MFT indicator switched off, the dialled digits display is cleared.

If the call is cleared during MFT state, the MFT converter in the MTX shall be disconnected.

The flow chart for this function is given in Fig. 1 and the corresponding signalling scheme is given in NMT Doc 450-1.

MTF-converter state

This sequence is overruled by fixed clearing, MS on hook and autonomous time-out. In the clearing sequence MFT- indicator OFF shall be included, and dialled digits memory and MFT OUT flag cleared.

Note 1: T = 1107 ms (8 frames)
T' = 553 ms (4 frames)

Note 2: When MFT converter IN/OUT button is pressed (activated) and MFT indicator is off, four frames 13a (L=8) shall be sent, and when MFT indicator is on, four frames 13a (L=7) shall be sent. Repeated activation of the MFT button shall initiate repeated transmission of the respective frames to MTX, which will acknowledge with appropriate frames.

Note 3: DDM = Dialed digits memory

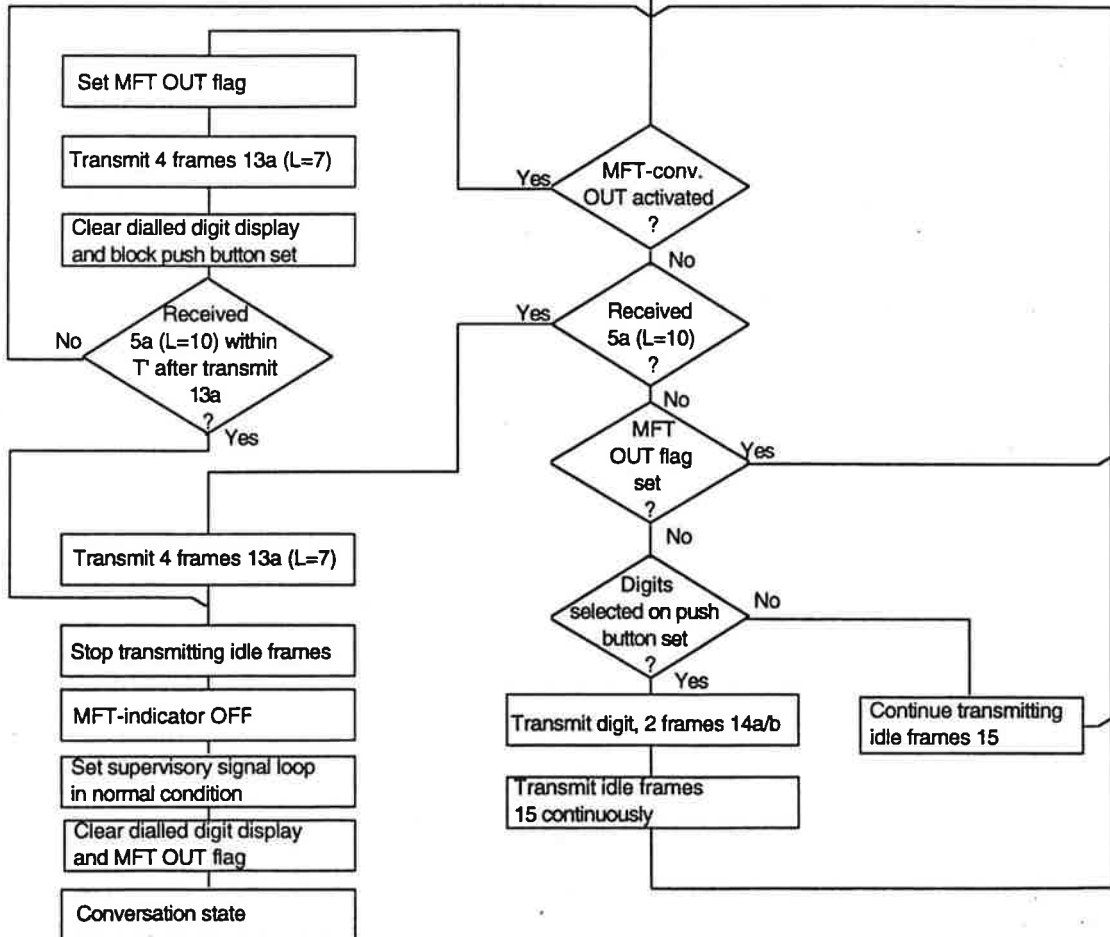
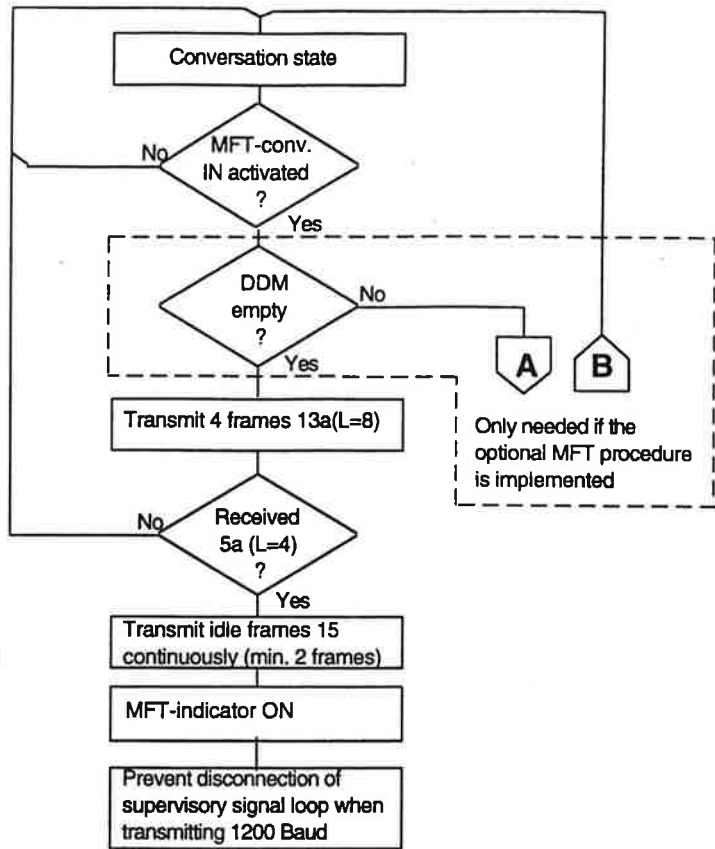

Fig. 1

2 Optional procedures

The following specification may optionally be used in combination with the "Specification for data transmission from the push-button set in MS".

If dialled digits memory and display contain information and MFT indicator is off, activating the MFT function in conversation state shall initiate transmission of the signal "MFT converter IN", the content of dialled digits memory is transmitted, followed by the "MFT converter OUT" signalling.

When the MFT state is abandoned, i.e. MFT indicator switched off, the dialled digits memory and display are cleared.

The flow chart for this function is given in fig. 2 and the corresponding signalling scheme is given in NMT Doc 450-1.

Note: Automatic invocation of the MFT converter IN/OUT function, e.g. via addressing it from a memory location, is allowed as long as the manual operation is still possible.

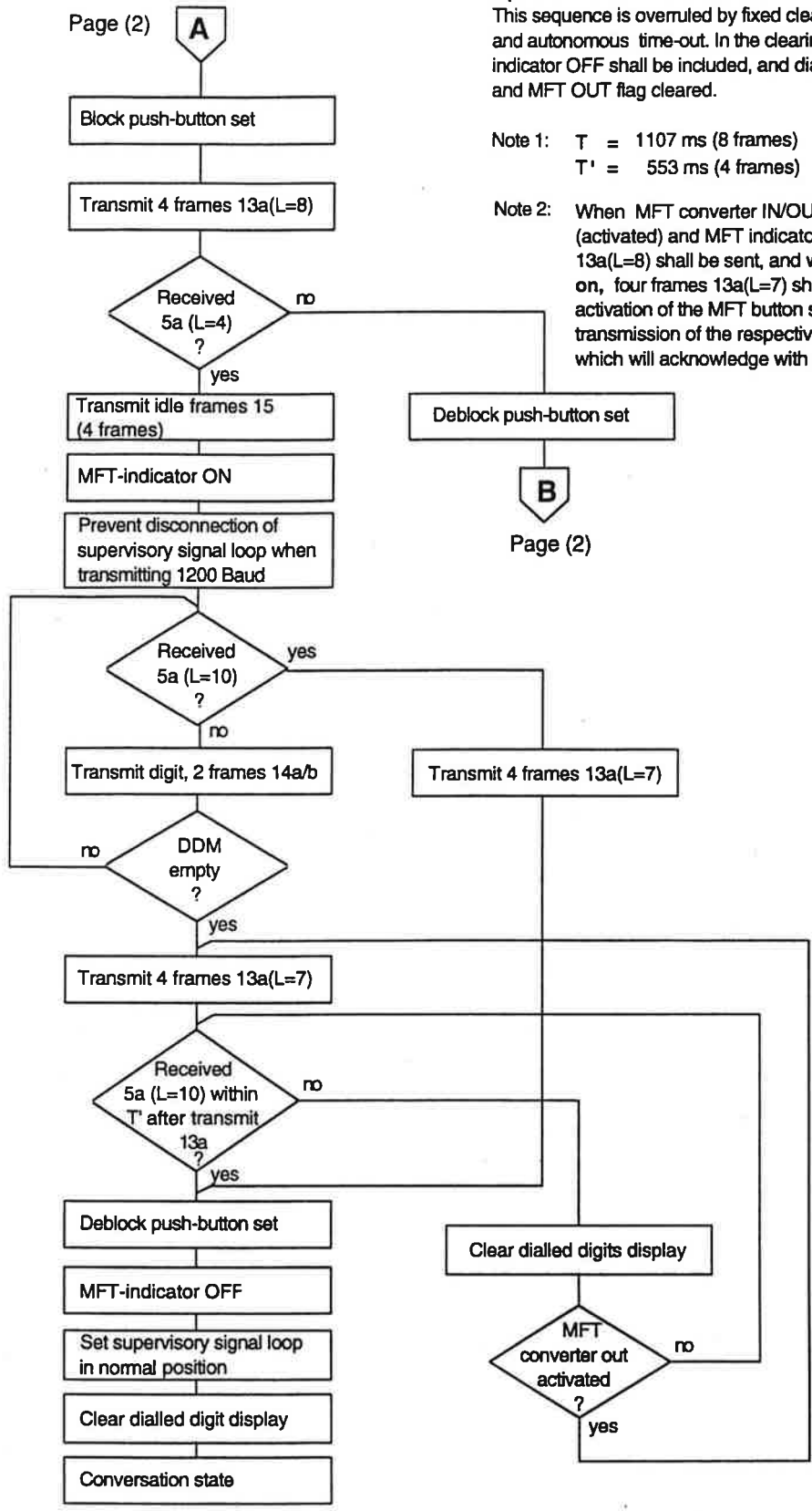

Optional use of MFT converter

This sequence is overruled by fixed clearing, MS on hook and autonomous time-out. In the clearing sequence MFT indicator OFF shall be included, and dialled digits memory and MFT OUT flag cleared.

Note 1: $T = 1107$ ms (8 frames)
 $T' = 553$ ms (4 frames)

Note 2: When MFT converter IN/OUT button is pressed (activated) and MFT indicator is off, four frames 13a(L=8) shall be sent, and when MFT indicator is on, four frames 13a(L=7) shall be sent. Repeated activation of the MFT button shall initiate repeated transmission of the respective frames to MTX, which will acknowledge with appropriate frames.

Fig 2

ANNEX 7

MOBILE STATION WITH INTERFACE FOR EXTERNAL EQUIPMENT

This annex specifies how external equipment, type approved for use in the Nordic telephone network, shall be connected to a mobile station in the NMT system. Connection of external equipment to an MS is subject to national (local) regulations.

1. Connection of external equipment for data transmission, telematic services, slow scan television etc. can be done in two ways:
 - i) The equipment is connected to the MS via a separate interface unit.
 - ii) The external equipment is integrated with the MS.

In addition to the specifications given in NMT Doc 450-1 and NMT Doc 450-3, the following shall apply.

Note: In order to distinguish between normal telephone operation of the MS and operation with an external equipment, the term *data mode* is used to indicate the latter.

2. The external equipment is connected to the MS via a separate interface unit.

This unit should preferably be made such that it can be connected to already type approved mobile stations.

- 2.1 The interface is shown in Figure 1:

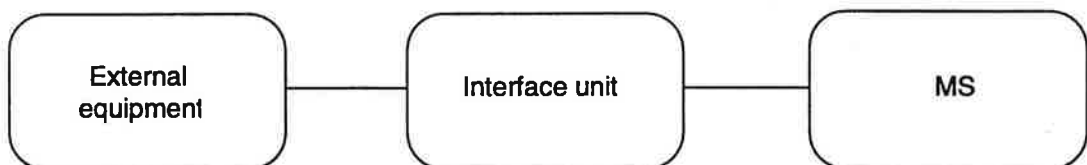

Figure 1. Interface between the external equipment and the MS.

The combination interface-mobile station shall fulfil the frequency response requirements specified for the mobile station in NMT Doc 450-3 Chapter 2 and 3, paragraph 2.2.12 and 2.3.20 with following relief.

The frequency response tolerances between 300 Hz and 3400 Hz shall be 1 dB wider. See. fig. 2 and fig. 3.

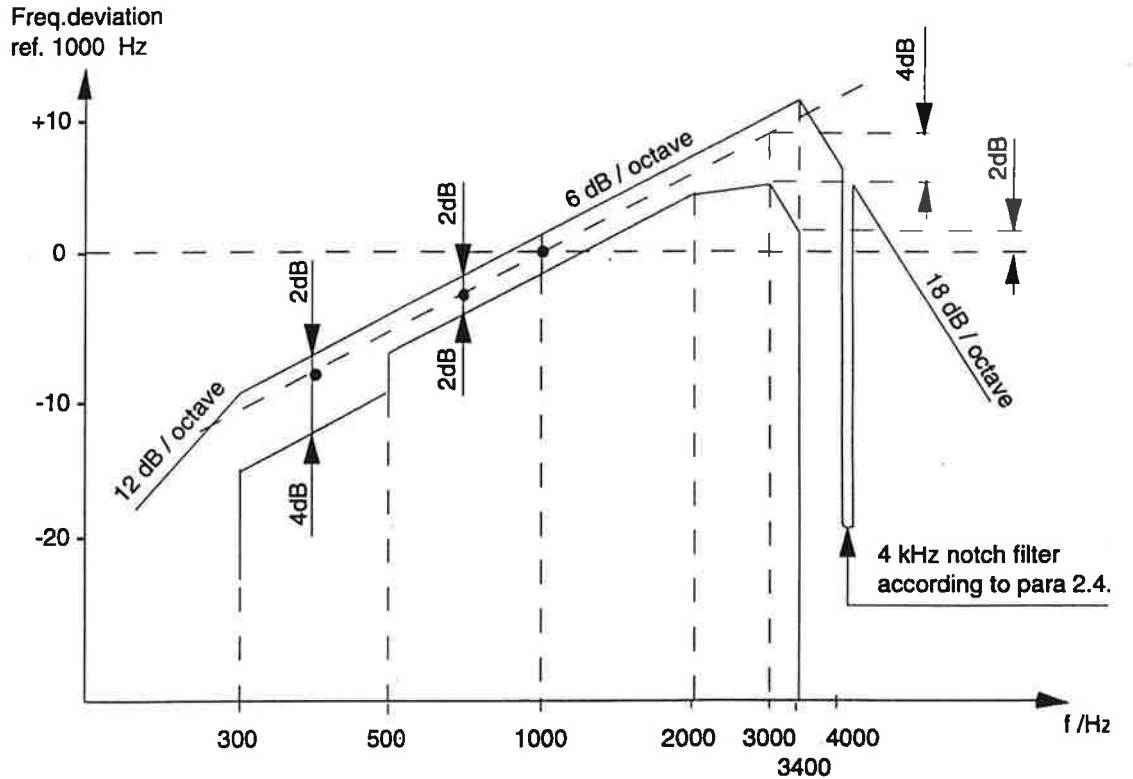

Figure 2. Audio frequency response of the combination transmitter line interface

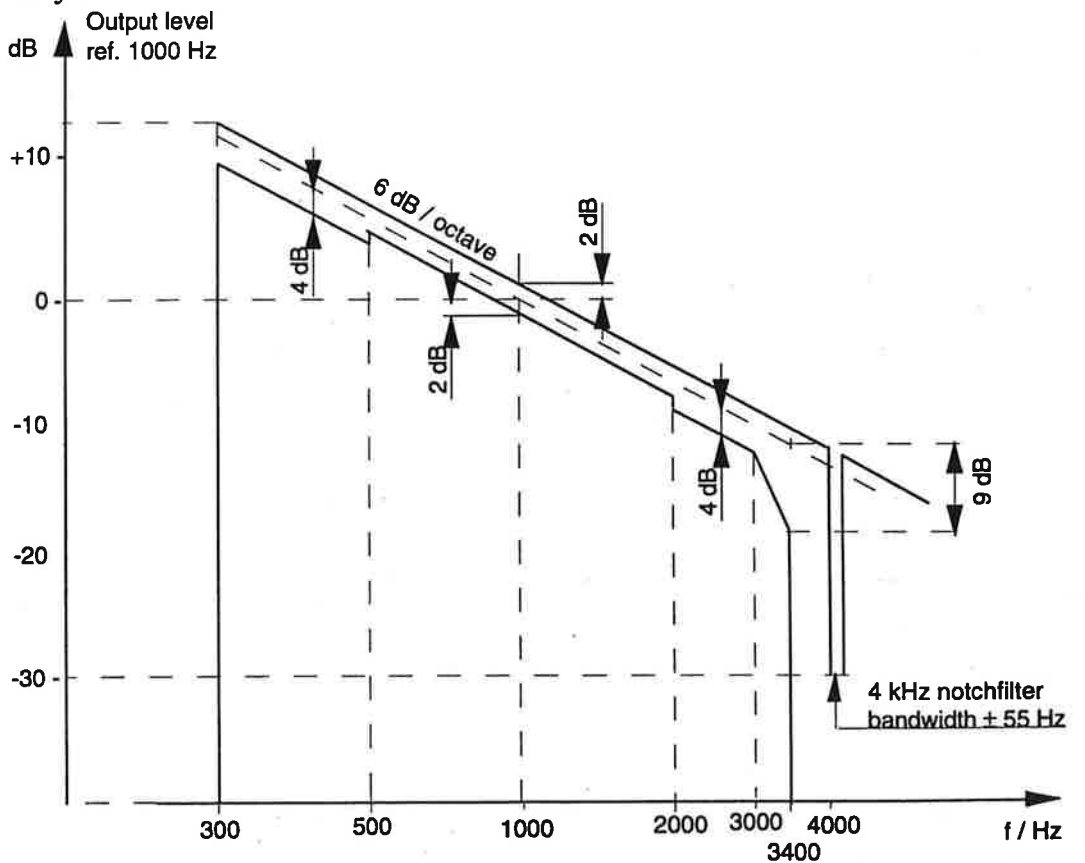

Figure 3. Audio frequency response of the combination receiver line interface

2.1.1 2-wire connection

Figure 4 shows the levels which apply for connecting an external equipment through a 4-wire/2-wire terminating set to a mobile station. It is assumed that the terminating set has an attenuation of 3,5 dB. If a terminating set with different attenuation is used, the levels indicated on the 2-wire side still apply. In Finland, Norway and Sweden the terminating set shall have a balancing network consisting of a resistance of 860 ohm in parallel with a 39 nF capacitor, see figure 5. In Denmark balancing impedance is 600 ohm.

The reflection attenuation (A_r) on the 2-wire side shall be ≥ 18 dB A_r re 860 Ω /39 nF.

(In Denmark A_r re 600 Ω .)

Receive

An 1 kHz tone with a peak-to-peak deviation of ± 3 kHz shall result in a level of -28 dBm ± 2 dB on the 2-wire side of the terminating set. If this corresponds to a level +R dBm at the output from the MS, an attenuator of (R+ 24,5) dB shall be inserted on the 4-wire side as shown in figure 5 (3,5 dB loss in the terminating set is assumed).

The power level is measured with an inserted load of 600 ohm.

Note: $R > - 24,5$ dB in order to avoid an additional amplifier.

Transmit

A 1 kHz tone at a level of -3 dBm ± 2 dB applied on the 2-wire side of the terminating set shall result in a peak-to-peak deviation of ± 3 kHz on the radio channel. If the deviation corresponds to -S dBm at the input to the MS, an attenuator of (-6,5 + S) dB (assuming 3,5 dB loss in the terminating set) must be inserted on the 4-wire side of the terminating set.

The power level is measured with an inserted load of 600 ohm.

Note: S should be chosen such that $S > 6,5$ dB in order to avoid an additional amplifier on the 4-wire side.

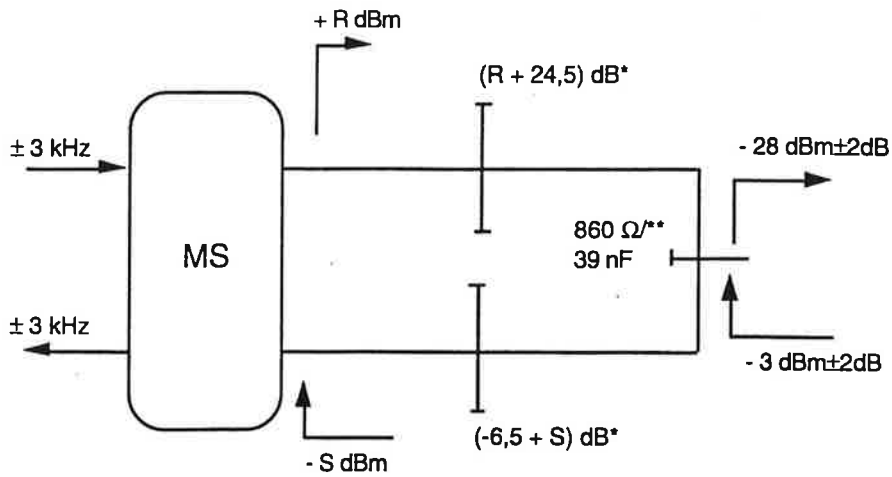

- * Assuming 3,5 dB loss in both directions of transmission in the terminating set
- ** 600 Ω in Denmark.

Figure 5. Measuring levels for connecting a terminating set to a mobile station

Note: The output level from the external equipment is supposed to be -10 dBm (i.e. 7 dB below the test-tone level) as is normally the case in some countries.

2.1.2 4-wire connection

Figure 6 shows the levels which apply for connecting a 4-wire terminating equipment to the MS.

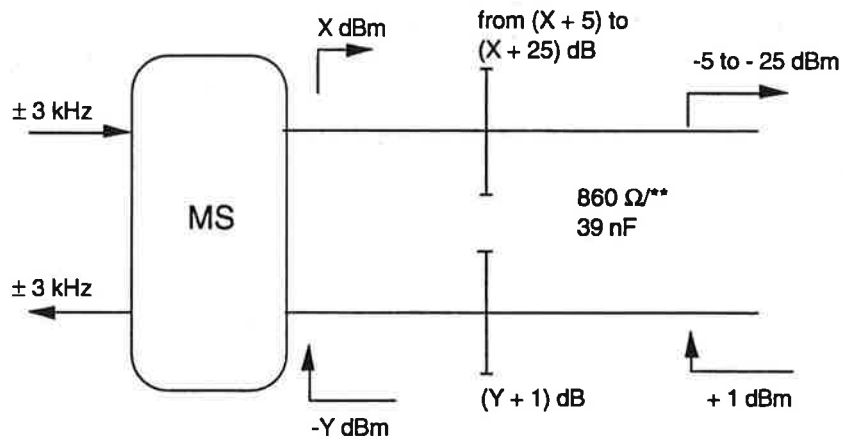

Figure 6. Measuring levels for connecting a 4-wire equipment to a mobile station

Receive

A 1 kHz tone with a peak-to-peak deviation of ± 3 kHz shall result in a level between -25 dBm and -5 dBm at the input of the external equipment. With a corresponding receive level of X dBm from the MS, an attenuator with the appropriate loss (between (X + 5) dB and (X + 25) dB) has to be inserted as shown in the figure 6.

The power level is measured with an inserted load of 600 ohm.

Note: The receive level X should be chosen such that the value of the attenuator is positive.

Transmit

A 1 kHz tone at a level of 1 dBm applied as shown in figure 5 shall result in a peak-to-peak deviation of ± 3 kHz. With a transmit level of -Y dBm an attenuator with loss Y + 1 dB has to be inserted as shown.

The power level is measured with an inserted load of 600 Ω .

Note: Y should be chosen such that $Y > -1$ dB in order to avoid an additional amplifier.

Note: The output level from the external equipment is supposed to be -6 dBm (i.e. 7 dB below the test-tone level) as is normally the case in some countries.

- 2.2 With external equipment the MS shall still be capable of detecting any signalling from the MTX (e.g. forced release).
- 2.3 Normal telephone operation of the MS shall be disabled when the external equipment is in the conversation phase. Switching between data mode and speech mode may be done either manually or automatically.

2.4 Optional automatic operation of reception shall be as follows:

Some external equipment (e.g. facsimile and data modems) may be equipped with an automatic call detection facility (circuit 125 in V24). This facility requires that the interface unit can simulate the calling function of the telephone network.

For each "ringing order" from the MTX to the MS, the interface unit shall generate a 20-55 ¹⁾ signal for a duration of 0,5 sec to 1 sec ²⁾. The voltage must be greater than 25 V r.m.s. ³⁾ but less than 100 V r.m.s. The minimum impedance of the loop is 7 k Ω .

2.4.1 The interface unit must be capable of detecting the off-hook condition from the external equipment. This would normally correspond to a drop in the DC loop resistance to less than 300 Ω (less than 400 Ω in Denmark and Finland).

The interface unit must be connected to the MS in such a way that the MS can initiate mobile clearing in the case the external equipment generates the on-hook condition.

2.4.2 The interface unit may include adaptation of dialling facility from an external equipment, in conformity with the requirements for the national telephone network.

2.5 Some equipment may require a DC line current of 25 mA in order to operate.

2.6 Any AC or DC voltages generated by the interface unit as defined above must be applied to the input or output of the MS.

2.7 Automatic equipment for transmitting may be specified by the manufacturer.

2.8 The circuit between the interface unit and the external equipment can be either 2- or 4-wire. The connector types shall be approved by the type approval authority. Information about connector types is available upon request from the type approval authority/accredited test laboratory.

2.9 In data mode the audio output need not be muted after reception of frame synchronization followed by six information bits of value zero.

1) In Denmark the interface unit shall generate either a 25 Hz $\pm 2,5$ Hz signal or a 50 Hz ± 5 Hz signal.

2) In Finland the duration shall be 1000 ms ± 150 ms.

3) In Denmark and Finland the voltage must be greater than 40 V r.m.s.

2.10 To the 2-wire connector of the type approval interface unit, it is allowed to connect without any additional type approvals following types of equipment, which have been type approved for the use in public switched telephone network in the country where the MS is registered:

- modems
- telecopy equipment
- other type of data equipment including a modem type approved for use in the public switching telephone network
- equipment for speech transmission

The output power for other signals than speech shall be lower than or equal to -10 dBm. The audio band modulation method shall not be similar to or cause interference to the NMT signalling system (FFSK). E.g. CCITT modem V.23 should not be used due to regular detection of false frames at the FFSK modem of the MTX.

Any other type of the external data equipment, e.g. equipment including a non standard modem, shall be type approved for the use in the NMT and the public switching telephone network.

3. External equipment integrated with the MS

The specifications given in section 2.1-2.9 shall still be met. A suitable method for automatic call detection may be determined by the manufacturer.

4. User Manual

The manufacturer shall provide a user manual together with the interface unit. The Administration reserves its right to comment on the manual.

5. Marking of the interface unit

The interface unit shall be marked in the same way as the MS.

6. Type approvals

The interface unit shall be type approved by the type approval authority.

The user manual shall be available when type approval is applied for.

Use of external equipment in other countries than the country in which the MS is registered, is subject to national regulations.

ANNEX 8 (OPTION)

1 SPECIFICATION FOR REGISTER RECALL FUNCTION

When implemented, all requirements shall be met.

Certain subscriber facilities which are activated during the call require a register recall function ("R-button"). In conversation state (i.e. lasting from reception of frame 3b to clearing) this button may not be used for other functions. The R-function shall be accessible by a one-key operation in conversation state, i.e. it shall not be hidden under shift mode or any other multi-key operation. In any other state this button may be used for other functions.

Examples of these services invoked by register recall are:

Hold for enquiry, conference service etc.

When the R-button is activated in conversation state, the MS transmits a series of signalling frames to the MTX. The signalling frames are acknowledged from the MTX, and a dialling tone is sent. When the acknowledgement frames are detected by the MS, the dialled digits memory (DDM) shall be cleared.

The digits which then are selected on the push button set are transmitted to the MTX in a non-encrypted form if frame 5a(L=3) is received from the MTX, and in an encrypted form if frame 5a(L=11) and frame 7 (including RAND) are received. If RAND is not received in the latter case, MS clears the call.

When the first digit is received in the MTX, the dialling tone is stopped.

When a sufficient number of digits is received in the MTX, address complete is sent to the MS.

The MS will then change to speech position and clear the display. When the received digit is analyzed, the MTX will enter the selected facility or set up a connection to the dialled subscriber number.

If the subscriber presses a wrong digit button while using the register recall function, the R-button must be reactivated and the transmission of digits restarted.

Note: Automatic invocation of the "R-functionality", e.g. via addressing it from a memory location, is allowed as long as the manual operation is still possible.

2 OPTIONAL PROCEDURE

If DDM and display contain information when the R-function is activated in conversation state, the "register recall" frames shall be sent to the MTX. The frames are acknowledged and dialling tone is sent. When acknowledgement frames are detected by MS, the content in DDM shall be transmitted followed by idle frames.

When a sufficient number of digits is received in the MTX, address complete is sent to the MS.

The MS will then change to speech position and clear the display. The MTX then activates whatever is requested by the transmitted digits.

The flowchart for this function is given in Fig. 1, and the corresponding signalling schemes are given in NMT Doc 450-1.

Register Recall funktion in MS

These sequences are overruled by fixed clearing, MS on hook and autonomous time out.

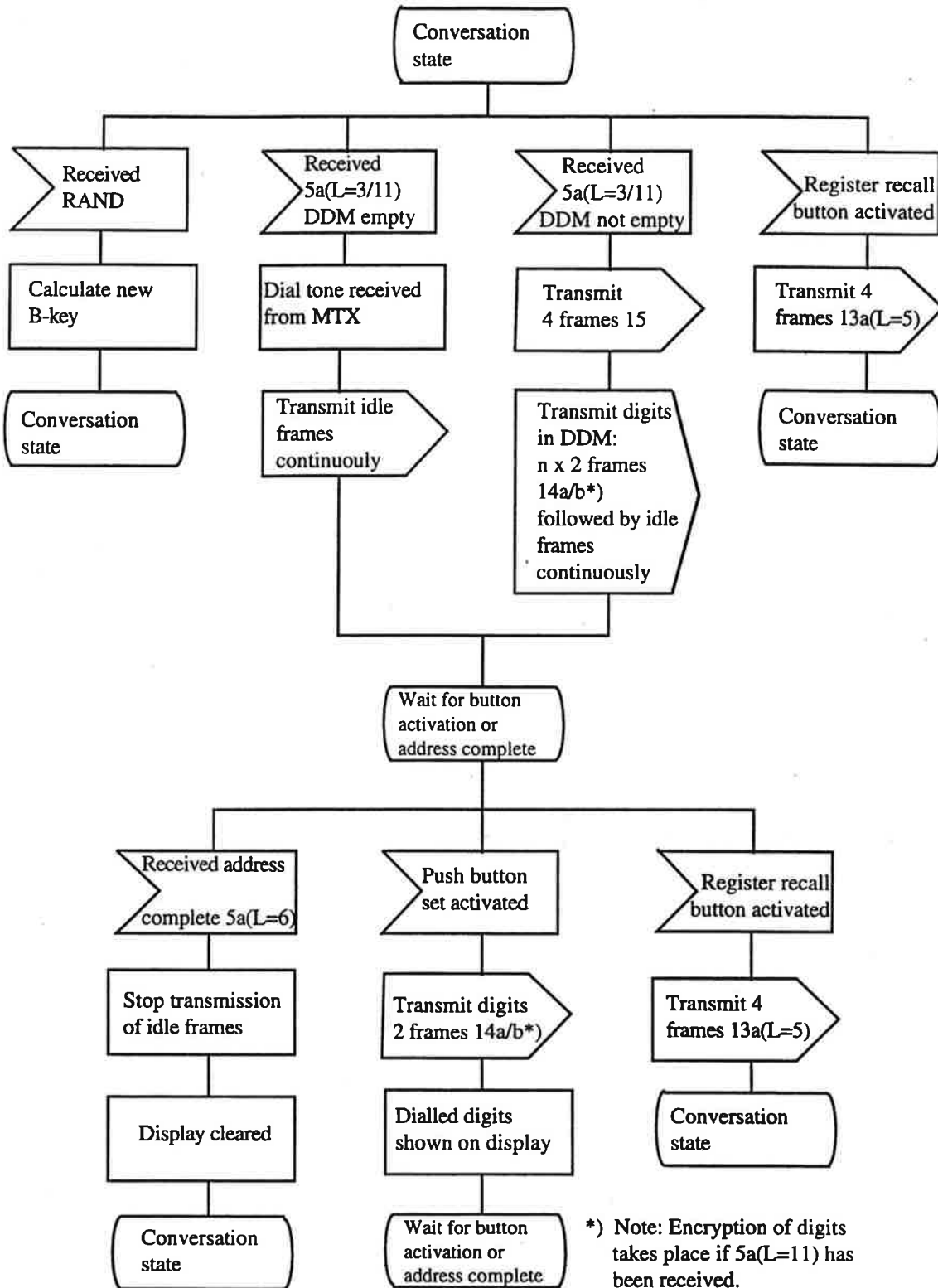

Fig. 1

ANNEX 9

MOBILE STATION FOR COMBINED USE (HMS WITH BOOSTER)

A Definition

Mobile station for combined use is a mobile station (MS), which contains a detachable unit in accordance with the definition for handheld mobile station (HMS) in Annex 3.

B Technical requirements

The detachable unit for use as handheld mobile station shall fulfil the requirements in Annex 3, paragraph B.

The mobile station for combined use shall unconditionally fulfil all requirements for ordinary mobile stations (MS).

ANNEX 11

MOBILE STATION EQUIPPED WITH MORE THAN ONE HANDSET AND/OR CONTROL UNIT

1. Definition

An MS may be equipped with more than one handset and/or control unit (called HS in this Annex).

2. Technical requirements

2.1 More than one HS, used simultaneously

It is subject to national regulations whether to permit a speech path to be opened in more than one handset at a time.

2.2 Electrical or mechanical differences

If the additional HS is not electrically and mechanically identical to the original one, but it requires the presence of the original HS, only the compliance to the following requirements has to be tested:

NMT Doc 450-3 paragraphs:

- 2.6.5 Receive volume control
- 2.6.8 Maximum sound level of handset earpiece
- 2.7 Stability loss

If the original HS includes a limiter, amplifiers etc., the additional HS shall be equipped with the same circuitry.

If it is possible to operate the MS with the original HS disconnected and the additional HS is not electrically and mechanically identical to the original one, full type approval tests shall be carried out.

If any call set-up devices are included in the HS e.g. keypad, all requirements for visual indicators have to be fulfilled.

2.3 Operation

The MS is regarded to be in "on-hook" state only if all HS are "on-hook".

The MS is regarded to be in "off-hook" state if any HS is "off-hook".