

NMT DOC.4.1981  
Nordic Mobile Telephone group

NORDIC



---

# MOBILE TELEPHONE

TECHNICAL SPECIFICATION FOR  
THE BASE STATION EQUIPMENT



# NMT-450

## NMT DOC 450-4

Base station



NORDIC MOBILE TELEPHONE

NMT

Technical specification for  
the base station equipment





1. GENERAL
  - 1.1 INTRODUCTION
  - 1.2 ABBREVIATIONS
  - 1.3 GENERAL SPECIFICATIONS
2. TEST CONDITIONS
  - 2.1 POWER SOURCES AND AMBIENT TEMPERATURES
  - 2.2 GENERAL CONDITIONS
  - 2.3 ACCURACY AT MEASUREMENTS
3. COMBINING EQUIPMENT
  - 3.1 TRANSMITTER COMBINER
  - 3.2 RECEIVER MULTICOUPLER
  - 3.3 DUPLEX-FILTER (70 W)
  - 3.4 DUPLEX-FILTER (350 W)
4. TRANSMITTER
  - 4.1 FREQUENCY RANGE
  - 4.2 NUMBER OF RF-CHANNELS
  - 4.3 FREQUENCY ERROR
  - 4.4 RF-CARRIER POWER
  - 4.5 CARRIER ON/OFF CONDITION AND CARRIER RISE/DECAY TIME
  - 4.7 INTERMODULATION ATTENUATION
  - 4.8 FREQUENCY DEVIATION
  - 4.9 SUPERVISORY SIGNAL INPUT CIRCUIT
  - 4.10 LIMITING CHARACTERISTICS OF THE MODULATOR (INCLUDING LINE INPUT CIRCUIT)
  - 4.11 CARRIER SHIFT DUE TO MODULATION
  - 4.12 ADJACENT CHANNEL POWER



- 4.13 NOISE POWER WITHIN RECEIVER CHANNEL
- 4.14 AUDIO FREQUENCY RESPONSE OF THE TRANSMITTER  
(INCLUDING LINE INPUT CIRCUIT)
- 4.15 HARMONIC DISTORTION FACTOR IN TRANSMISSION
- 4.16 RELATIVE AUDIO FREQUENCY INTERMODULATION PRODUCT  
LEVEL OF THE TRANSMITTER
- 4.17 RESIDUAL MODULATION
- 4.18 SENSITIVITY OF MODULATOR, INCLUDING CONTROL UNIT (CU)
- 4.19 INPUT IMPEDANCE
- 4.20 IMPEDANCE SYMMETRY
- 4.21 GROUP DELAY DISTORTION
- 4.22 MODULATION DUE TO VIBRATION
  
- 5. RECEIVER
  - 5.1 FREQUENCY RANGE
  - 5.2 NUMBER OF RF-CHANNELS
  - 5.3 RF-SENSITIVITY
  - 5.4 CO-CHANNEL REJECTION
  - 5.5 ADJACENT CHANNEL SELECTIVITY
  - 5.6 SPURIOUS RESPONSE REJECTION
  - 5.7 INTERMODULATION REJECTION
  - 5.8 BLOCKING
  - 5.9 SPURIOUS EMISSIONS
  - 5.10 AUDIO FREQUENCY POWER TO LINE
  - 5.11 LINE OUTPUT IMPEDANCE
  - 5.12 IMPEDANCE SYMMETRY
  - 5.13 AMPLITUDE CHARACTERISTIC OF THE RECEIVER LIMITER
  - 5.14 AM-SUPPRESSION



- 5.15 AUDIO FREQUENCY RESPONSE OF THE RECEIVER  
(INCLUDING LINE OUTPUT CIRCUIT)
- 5.16 HARMONIC DISTORTION FACTOR
- 5.17 RELATIVE AUDIO FREQUENCY INTERMODULATION PRODUCT  
LEVEL OF THE RECEIVER
- 5.18 NOISE AND HUM OF THE RECEIVER
- 5.19 GROUP DELAY DISTORTION
- 5.20 SQUELCH
- 5.21 AUDIO OUTPUT DUE TO VIBRATION
  
- 6.    SIGNALLING BETWEEN MTX AND BASE-STATION
  
- 7.    SIGNAL STRENGTH RECEIVER (SR)
  - 7.1   GENERAL
  - 7.2   SPECIAL REQUIREMENTS
  
- 8.    CONTROL UNIT
  - 8.1   BASIC FUNCTIONS
  
- 9.    SUPERVISORY UNIT (SU)
  - 9.1   BASIC FUNCTIONS
  
- 10.   RF TEST LOOP
  
- ANNEX 1.  A CALCULATION OF SOME CRITICAL PARAMETERS IN  
              COMBINING EQUIPMENT IN RELATION TO THE  
              TRANSMITTER/RECEIVER REQUIREMENTS.





## 1. GENERAL

### 1.1 INTRODUCTION

This technical specification presented as NMT Doc.4.1981 refers to base station equipment for the Nordic mobile telephone network (NMT).

A general description of the NMT system is given in NMT Doc.1.1980 or its latest edition.

This present document is a revised edition of the NMT Doc.4.1978.

The base stations will be connected to the mobile telephone exchange (MTX) through dedicated telephone lines. The base station has to meet all relevant functional requirements of the NMT system and shall fulfil the requirements in this specification.

### 1.2 ABBREVIATIONS

A	subscriber	Calling subscriber
B	subscriber	Called subscriber
BS		Base station
BSA		Base station area
CC		Calling channel
CU		Control unit
FFSK		Fast frequency shift keying
MFC		Multi frequency code signalling
MFT		Multi frequency pulsed signalling
MS		Mobile station
MTX		Mobile telephone exchange
MTXH		Home mobile telephone exchange
MTXV		Visited mobile telephone exchange
NMT		Nordic mobile telephone system
RF		Radio frequency
SF		Fixed subscriber
SLU		Switching logic unit
SM		Mobile subscriber

SR (FR)	Signal strength receiver
SU	Supervisory unit
TA	Traffic area
TAH	Home traffic area
TAV	Visited traffic area
TC	Traffic channel
VF	Voice frequency
∅ signal	Supervisory signal
TMS	Test mobile subscriber

1.3 GENERAL SPECIFICATIONS

1.3.1 Base station units

The base station may consist of the following functional units:

- Transmitter combiner
  - Receiver multicoupler
  - Duplexfilter
  - Transmitter
  - Receiver
  - Control unit (CU)
  - Signal strength receiver (SR)
  - Supervisory unit (SU)
  - RF test-loop, figure 3 and figure 4.
- } alternative 1, figure 1
- } alternative 2, figure 2

In the physical realization of the equipment it is desirable, from the maintenance point of view, that the different functional units are built up by separate modules.

The base station shall be controlled from the mobile telephone exchange through four-wire lines which carry speech and signaling.

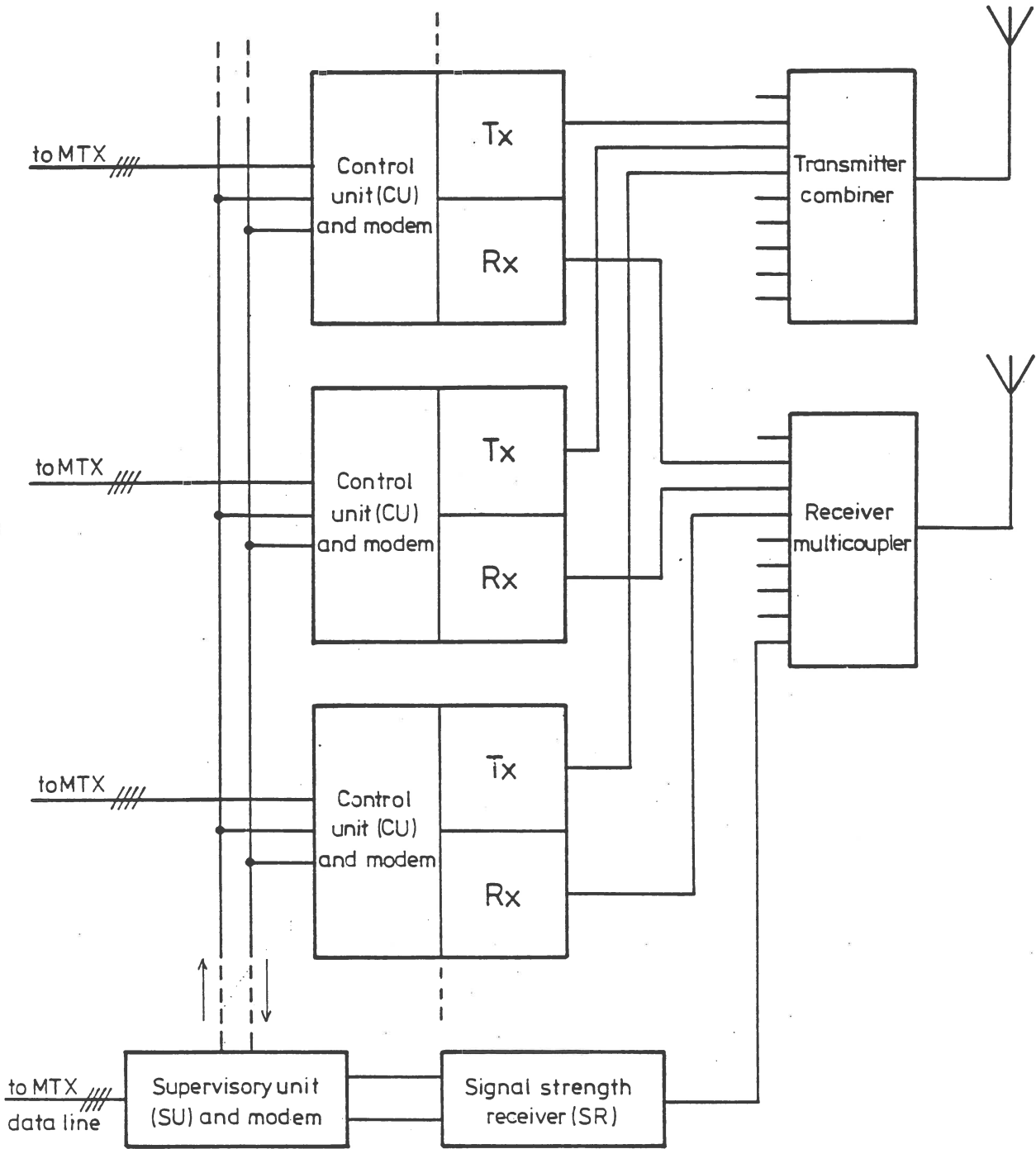

Note 1 It shall be possible to connect at least 40 channels to one supervisory unit. The maximum distance between cabinets will be 100m. See also note 1 under fig. 2.

Figure 1 Base station functional units, alternative 1.

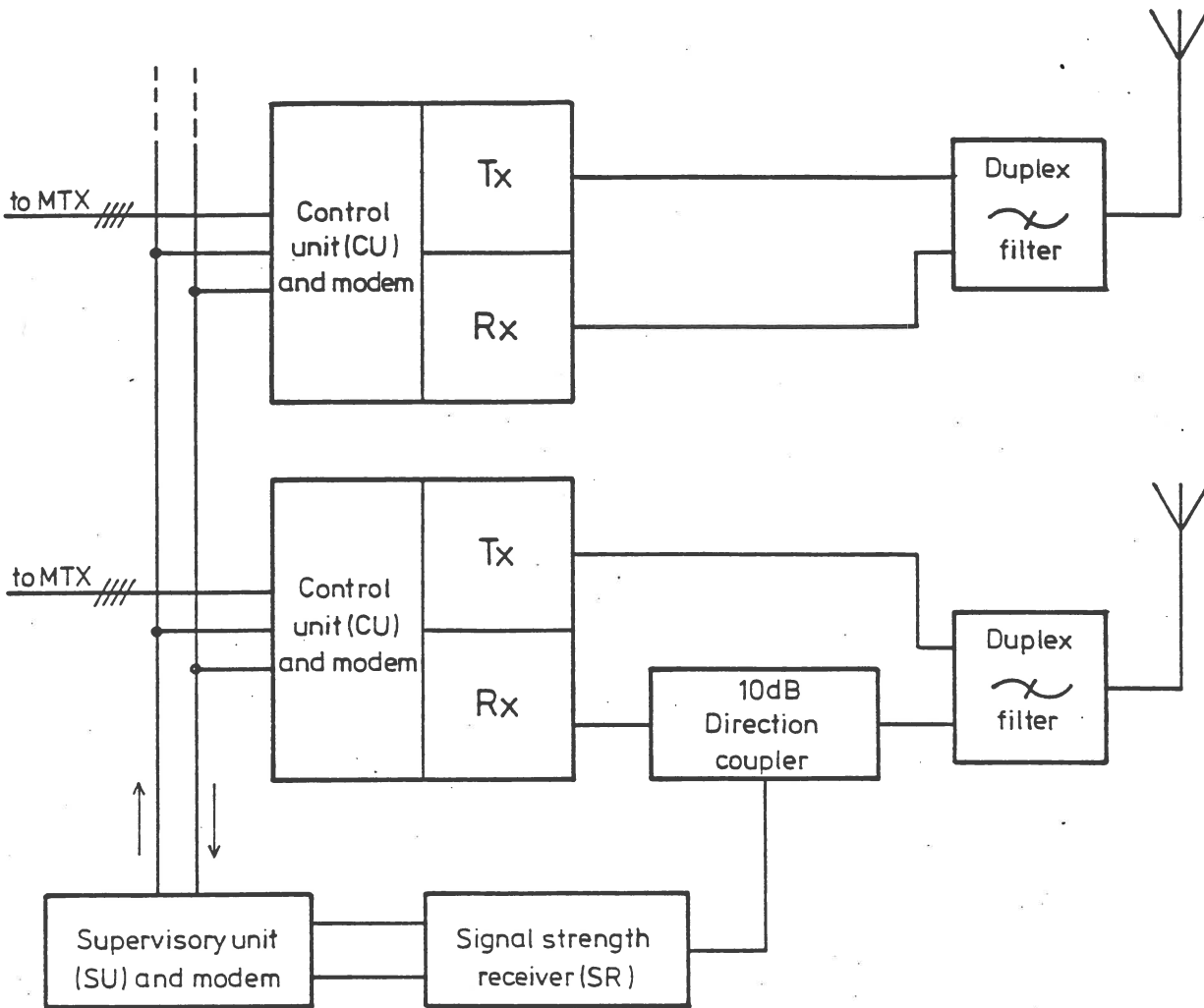

Note 1 The separate SU and modem may be deleted if its tasks are carried out by the CU and SR.

Figure 2 Base station functional units, alternative 2.

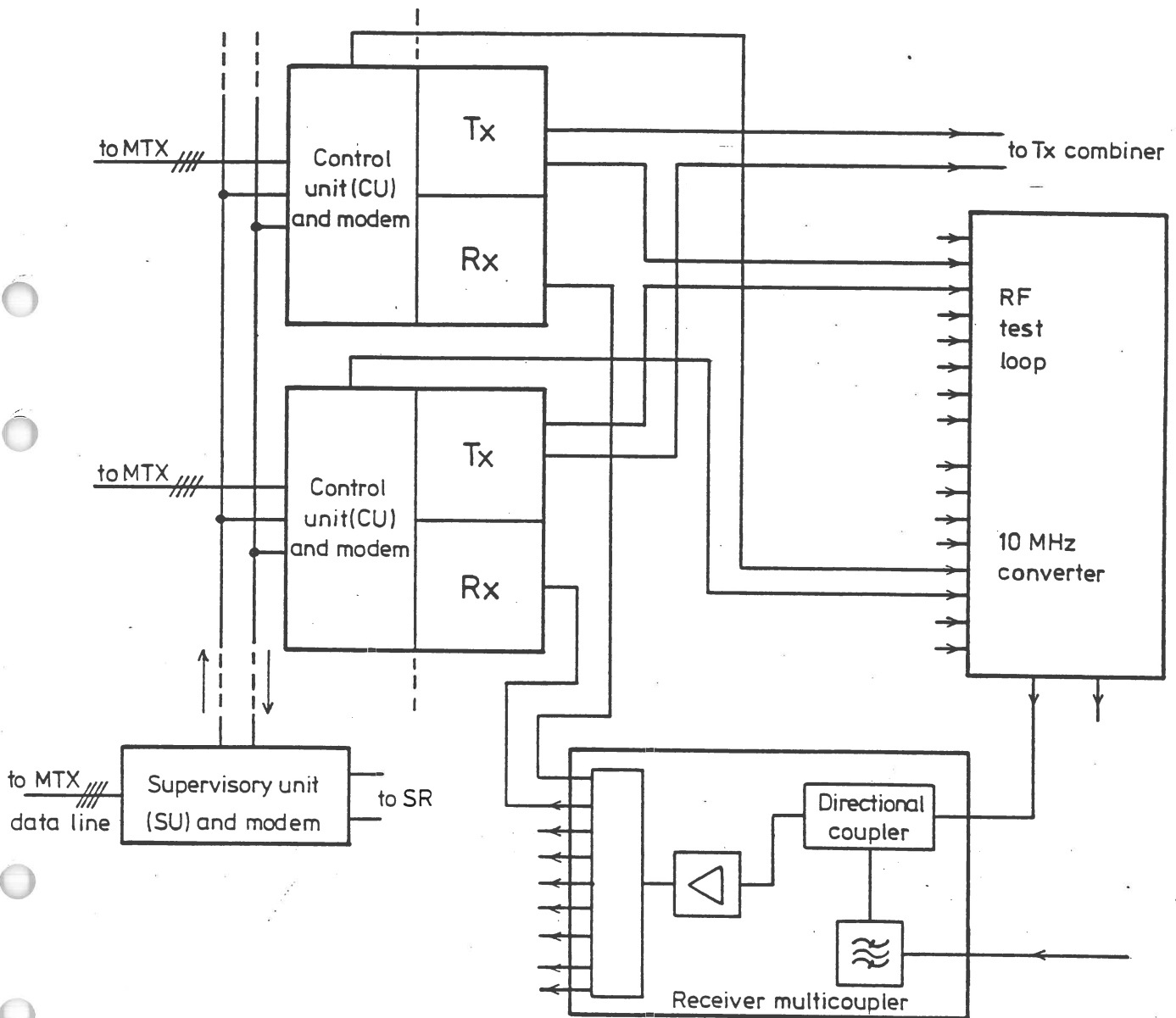
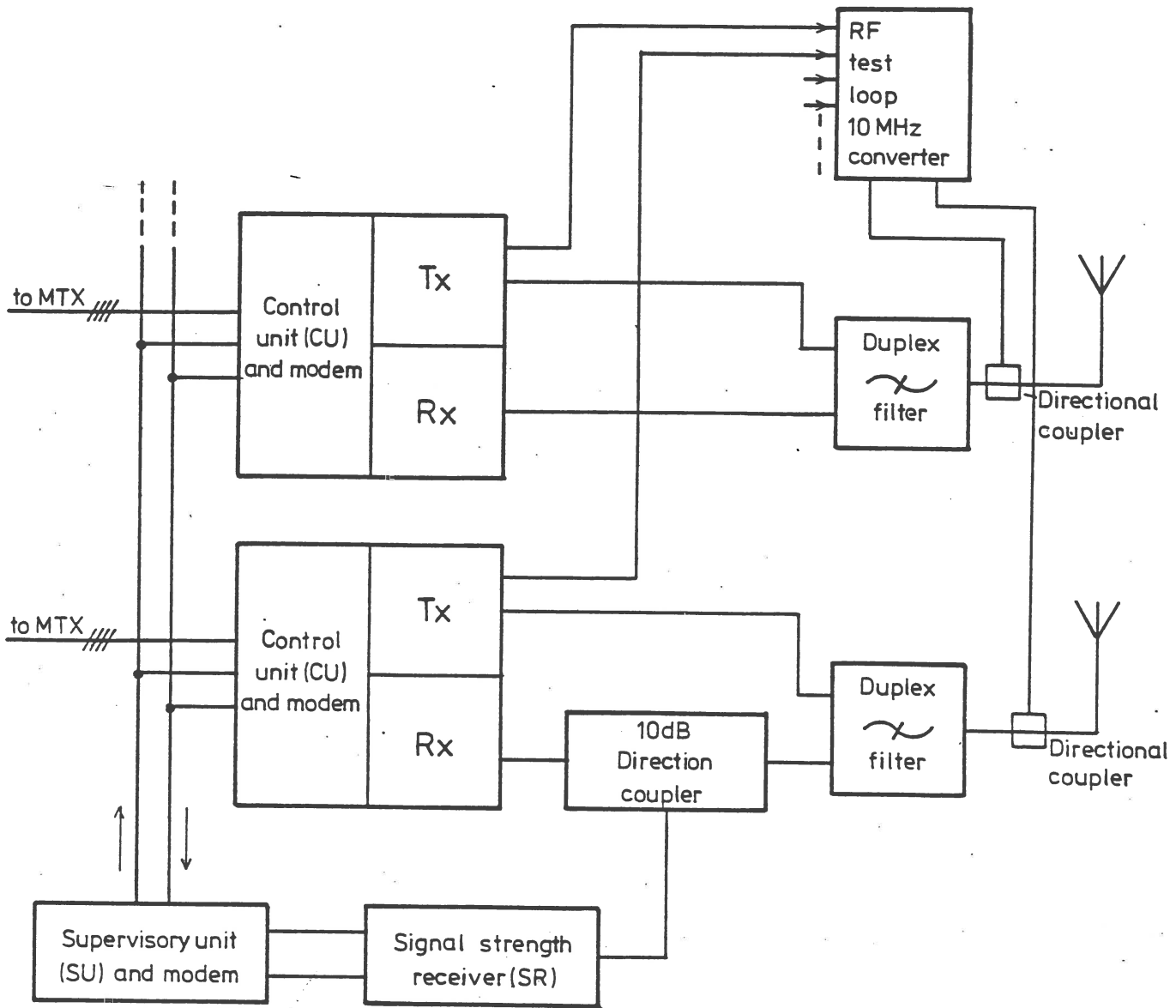

Figure 3 RF test-loop, alternative 1



Note 1 Also other alternatives may be considered.

Figure 4 RF test-loop, alternative 2

1.3.1.1 Combining equipment

- The transmitter combiner shall give the possibility to combine several transmitters to a common antenna. It shall permit simultaneous connection of up to at least 8 transmitters.
- The receiver multicoupler shall correspondingly permit connection of several receivers to a common reception antenna. Number of receiver outputs shall be at least 10.
- The duplex filter shall connect the transmitter and the receiver of one channel to a common antenna. It shall provide the attenuation between the transmitter output and the receiver input required to permit duplex operation.

1.3.1.2 Transmitter and Receiver units.

The transmitter and receiver shall provide signalling and voice transmission and reception.

1.3.1.3 Control unit (CU)

The control unit shall provide functions for each actual channel equipment and interface between MTX and the channel. It shall also be able to transfer data information between SU and MTX.

Primary functions:

- start and stop of transmitter remotely controlled from MTX;
- send channel station information back to MTX as acknowledgement for channel activation order;
- channel setting remote controlled from MTX;
- send fault alarm to MTX;
- loop connection of transmitter line input and receiver line output as ordered from MTX, or at fault in CU-modem;
- control the RF test loop for the actual channel,
- generate supervisory signal to the transmitter as ordered from MTX and detect the received supervisory signal looped in the mobile station and send the evaluated result to MTX;
- local control and service functions:  
start/stop of transmitter, channel setting, activation of squelch, RF test loop and supervisory signal, send block/de-blocking signal to MTX, test measurements.



1.3.1.4 Signal strength receiver (SR)

The signal strength receiver shall provide measurement of radio frequency signal strength on channel ordered from the supervisory unit (SU). The signal strength information shall be sent to SU.

1.3.1.5 RF test-loop

The RF test-loop shall provide a 10 MHz frequency conversion of a small portion of the transmitter output power and loop this signal to the receiver for testing purposes performed in the MTX.

The RF test-loop may be common for several channels, and the selection of channel to be looped as ordered from the MTX via the actual channel line shall be controlled by the CU.

1.3.1.6 Supervisory unit (SU)

The supervisory unit is a functional unit which shall:

- order the SR to measure the signal strength on the channel as ordered from MTX. The result shall be evaluated and information sent to MTX.
- be able to send fault alarms to MTX.
- loop connection of data line input and output as ordered from MTX, or at fault in SU-modem.

1.3.2 Radio frequency plan

The radio frequency range allocated to the Nordic Mobile Telephone service is 453,0 - 457,5/463,0 - 567,5 MHz.

The channel spacing is 25 kHz and the frequency separation between the transmit and receive channels is 10 MHz.

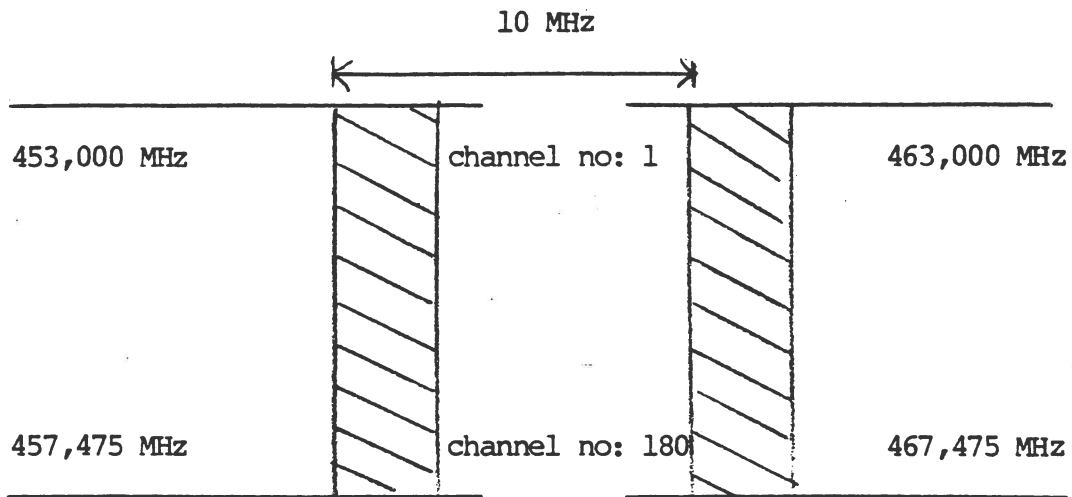

The NMT-system has 180 channels. Channel number 1 is 453,000/463,000 MHz and channel number 180 is 457,475/467,475 MHz. The high frequency segment contains the base station transmit channels. The low frequency segment contains the base station receive channels.

1.3.3 Crosstalk

The purpose of this clause is to limit the crosstalk between the transmit and receive direction of one single channel and between arbitrary channels mounted in the same transmitter and receiver cabinet.

1.3.3.1 Crosstalk between a transmitter line input and any other line terminal

The measurements shall be made between two arbitrary channels in the cabinet. The transmitters of the two channels shall be in transmit condition and connected to artificial antennas.

An audio frequency test signal with nominal input level given in paragraph 4.18.3 shall be applied to the line input of the first transmitter to give normal test modulation defined in paragraph 2.2.4.1. The second transmitter shall be unmodulated.

Each of the two receiver inputs shall be supplied with an unmodulated test signal with a level of 30 dB (1 μV)E.M.F. at a frequency equal to the nominal frequency of the receiver. The nominal audio frequency output level shall correspond to paragraph 5.10.3.

The four line terminals shall be terminated in 600 ohms resistive loads and the audio frequency levels shall be measured by a selective voltmeter connected to the line terminals.

The audio level measured at the second transmitter line input shall not exceed -60 dB relative to the signal level at the first transmitter.

The levels measured at the receiver line outputs at both channels shall not exceed -60 dB relative to the nominal audio output level.

The requirements shall be fulfilled for any combination of two channels contained in the same transmitter and receiver cabinet.

1.3.3.2 Crosstalk between a receiver line output and any other line terminal

The measurements shall be made between two arbitrary channels in the cabinet.

The transmitters of the two channels shall be in transmit condition and connected to artificial antennas. The transmitters shall be unmodulated.

The input of the first receiver shall be supplied with a test signal at a frequency equal to the nominal frequency of the receiver. The signal shall have normal test modulation as defined in paragraph 2.2.4.1 and shall have a level of 30 dB (1  $\mu$ V)E.M.F. The audio output level of the receiver shall be set to the nominal output level given in paragraph 5.10.3.

The second receiver input shall be supplied with an unmodulated test signal with a level of 30 dB(1  $\mu$ V)E.M.F at a frequency equal to the nominal frequency of the receiver.

The four-line terminals shall be terminated in 600 ohms resistive loads and the audio frequency levels shall be measured by a selective voltmeter connected to the line terminals.

The audio level measured at the second receiver line output shall not exceed -60 dB relative to the signal level at the first receiver line output.

The audio level measured at the transmitter line outputs at both channels shall not exceed -60 dB relative to the nominal input level given in paragraph 4.18.3.

The requirements shall be fulfilled for any combination of two channels contained in the same transmitter and receiver cabinet.

1.3.4 Transmitter-cabinet intermodulation components

The purpose of this clause is to limit the radio frequency intermodulation components generated by internal radiation between transmitters mounted in the same cabinet.

All transmitters in the cabinet shall be in transmit condition and unmodulated. Each transmitter shall be connected to an artificial antenna.

Any intermodulation component measured at an arbitrary transmitter output shall not exceed -70 dB relative to the corresponding transmitter carrier power except for the 5th order intermodulation components within the frequency range 453,000 to 457,500 MHz which shall not exceed -95 dB relative to the corresponding transmitter carrier power.

#### 1.3.5 Cabinet radiation

Will be specified later.

#### 1.3.6 Reliability

The equipment shall be designed for continuous operation (transmit and receive condition respectively). The mean time between failure (MTBF) for the base station equipment is specified for two groups.

Failure is in this context defined as a functional failure or a deviation from the requirements in the technical specification.

##### Group A:

Channel equipment consists of one transmitter, one receiver, one control unit and one duplex filter.

The MTBF shall be at least 8000 hours for the total channel equipment.

##### Group B:

Common equipment which means equipment common for several radio channels. These equipments are transmitter combiner, receiver multicoupler, signal strength receiver, supervisory unit, RF test-loop, common AC/DC converter and/or DC/DC converter.

For each of these individual equipments the MTBF shall be at least 40 000 hours.

The confidence level for the evaluation is fixed to be 80%.

The MTBF-figures shall be valid for a period of 10 years starting at the end of the guarantee period.

The manufacturer shall state the predicted MTBF for each group and shall by calculations show how the MTBF values are obtained.

In case of using redundancy circuits a failure (of an active component) shall not be regarded as a failure of the equipment in the MTBF calculations if the equipment is still working without a significant degradation in performance. In this case the equipment shall be provided with means for indication of failure in the active component.

### 1.3.7 Statical charging

To prevent statical charging of the equipment from the antenna, with possible damage to the equipment, the RF output/input circuits shall have a galvanic connection to earth.

### 1.3.8 Safety requirements

The equipment shall fulfil the relevant requirements in IEC Publication 215 "Safety requirements for radio transmitting equipment", category B and relevant requirements in IEC Publication 65 "Safety requirements for mains operated electronic and related apparatus for household and similar general use".

### 1.3.9 Power source

The equipment shall be capable of being supplied either directly from the mains or from an external battery with buffer. Both possibilities are desired, but only one type of power source will be in use at each base station.

- Nominal mains voltage is 220 V, 50 Hz.
- Nominal voltage for the battery is 48 V, positive pole grounded.

The power supply unit shall be provided with a fuse (fuses) and a switch or corresponding which affects to the primary side (-48 V or 220 V). Fuse(s) shall be located on the front panel.

### 1.3.10 Marking of the equipment

The function of all pilot lamps, terminals, and controls as well as the position of the controls, shall be clearly indicated on the equipment.

The equipment shall be clearly marked with the make, type designation, and serial number of production.

The marking shall be placed on the equipment in such a manner that it is easy to see when the equipment is placed in its normal position.

The marking shall be mechanically solid and durable and may, for example, be made by means of engraving, embassing or application of a metal plate.

### 1.3.11 Measuring points

For maintenance reasons the equipment (printed circuit boards) shall be provided with clearly marked measuring points, the typical measuring values of which shall be stated in the service manual.

### 1.3.12 Construction

It is preferred that the base station equipment is built to fit into a cabinet with standard 490 mm (19") rack mounting and a height of maximum 2100 mm and a depth of maximum 600 mm. The cabi-

net shall be designed in such a way that no access to the backside of the cabinet is required. It shall thus be possible to mount the cabinets back-to-back or against the wall. No unit except the cabinet shall be heavier than one man can handle.

As an option a mechanical arrangement may be required where two channel equipments (transmitter, receiver, duplex filter, control unit, supervisory unit, signal strength receiver, AC/DC or DC/DC converter) are mounted in a small rack which can be mounted on a wall.

### 1.3.13 Environmental requirements

#### 1.3.13.1 Temperature range

The equipment shall fulfil the specified requirements within the temperature range  $-10$  to  $+55^{\circ}\text{C}$ . The test conditions are specified in clause 2.1.

#### 1.3.13.2 Power source voltage

The equipment shall fulfil the specified requirements within following alternative power source voltage ranges:

- $220\text{ V} \pm 10\%$ ,  $50\text{ Hz} \pm 1\text{ Hz}$ . The equipment shall not give any malfunctions within  $220\text{ V} + 15\%$  and  $-20\%$ .
- $43$  to  $63\text{ V DC}$ , positive pole grounded.

The test conditions are specified in clause 2.1.

#### 1.3.13.3 Mains transients

The equipment shall be designed in such a way that mains transient with an amplitude of  $\pm 30\%$  from normal mains voltage  $220\text{ V}$  with a duration of maximum  $2\text{ s}$  or transients with an amplitude of  $2\text{ kV}$  and with a duration of maximum  $1\text{ ms}$  will not cause permanent defects in the equipment.

At tests a pulse generator will be used, giving  $2\text{ kV}$  transients and having an impedance of appr.  $40\text{ ohms}$ .

The transient has saw-tooth characteristics with a rise time  $10\text{ }\mu\text{s}$  and a fall time down to  $50\%$  equal to  $1\text{ ms}$ . The transient shall be superposed to the mains.

### 1.3.13.4 Transients from DC-power source

The equipment shall be able to withstand transients from the DC-power source according to Fig. 5 without permanent defects.

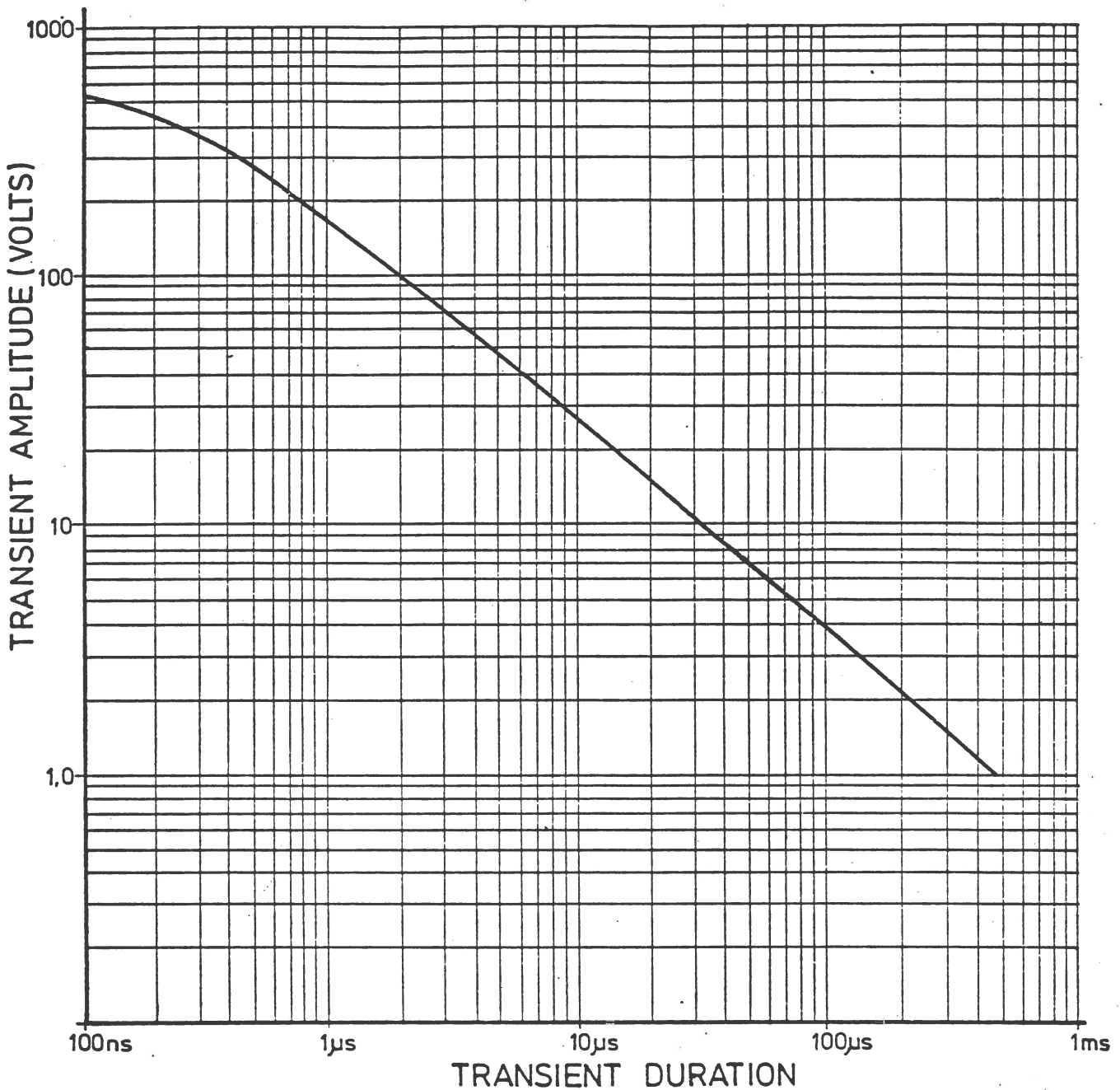

Figure 5 Permitted transient voltage amplitude and durations from DC-power source with battery back-up.

### 1.3.13.5 Noise from DC-power source

The equipment shall fulfil all specifications with noise up to 93 V rms within the frequency range 10 to  $3 \times 10^7$  Hz from the DC-power source.



1.3.13.6 Over-voltage at line input/output

Necessary protection against damages caused by overvoltage applies at line input/output circuits shall be made as to withstand:

a) Impulsive voltage

Amplitude: 1500 V  
Risetime: 10  $\mu$ s (1/2 amplitude)  
Falltime: 700  $\mu$ s (1/2 amplitude).

The voltage shall be applied between the two wires which constitute the transmitter line input or the receiver line output as well as between one of the wires and earth.

b) Mains voltage, 50 Hz

Amplitude: 1000 Veff  
Duration: 500 ms

The voltage shall be induced between one of the wires and earth.

c) Mains voltage, 50 Hz

Amplitude: 350 Veff  
Duration: 500 ms

The voltage shall be induced between the two wires which constitute the transmitter line input or the receiver line output. Generator impedance shall for case a) be appr. 40 ohms and for case b) and c) 125 ohms.

1.3.13.7 Malfunctions

The base station equipment shall not malfunction at mains interruption, power start-up, mains transients, mains frequency offset +5 Hz or DC-power source transients.

1.3.13.8 Bump test, non operating

The test shall be carried out in accordance with the recommendations of IEC publ. 68-2-29 (1968) Test Eb, Bump. The pulse shall be halfsine of 6 ms duration and 245 m/s<sup>2</sup> peak acceleration. The equipment shall be tested in three mutually perpendicular directions of the six possible attitudes, making a total of 1000 bumps in each direction.

The equipment shall be tested as discrete units. During the test the equipment shall be nonoperative. Applicable checks shall be made immediately after completing the test.

1.3.14 Power supply radiation

Interference voltage shall fulfil the requirements according to IEC recommendation no. 43, Publication 7a.

1.3.15 Acoustic noise

The acoustic noise from the equipment shall be measured according to ISO 3743. The radiated sound power from the equipment shall not exceed  $L_w$  60 dB(A) relative 1 pW.

If the noise is of impulse type or contains audible tones, the radiated sound power from the equipment shall not exceed  $L_w$  50 dB(A) relative 1 pW.

1.3.16 Noise from DC-power supply against DC-power source with battery back-up

The maximum allowed noise voltage from each equipment unit except the rectifier is given in Fig. 6. The limits are r.m.s. values measured with a spectrum analyzer on the DC supply terminals of the unit.

In the frequency range of 100-5000 Hz Fig. 6 represents the limit of the maximum voltage of the largest noise component. The total noise contribution from the equipment unit shall not exceed 0.1 mV measured with a psophometer on the DC supply terminals of the unit.

The measuring instruments are specified in Table 1.

The measuring arrangement is shown in Fig. 7. The battery conductions (DC bus bars) are equivalated by a series connection of a resistor of 0,1 ohm and an inductor of 0,1 mH. The battery shall have a capacity of typically 150 Ah/10 h. In place of an accumulator battery a voltage source with high internal resistance in parallel with a capacitor of 10 000  $\mu$ F may be used.

Measuring instrument	Specification
Phophometer	Input impedance: 10 kohms Weighting curve: CCITT Rec. P. 53A (vol. V)
Spectrum	Input impedance: 100 kohms Selective bandwidth: 10 Hz (0 - 1 kHz) 30 Hz (1 - 50 kHz) 3 kHz (over 50 kHz) Reading: r.m.s. voltage

Table 1. Specification of measuring instruments

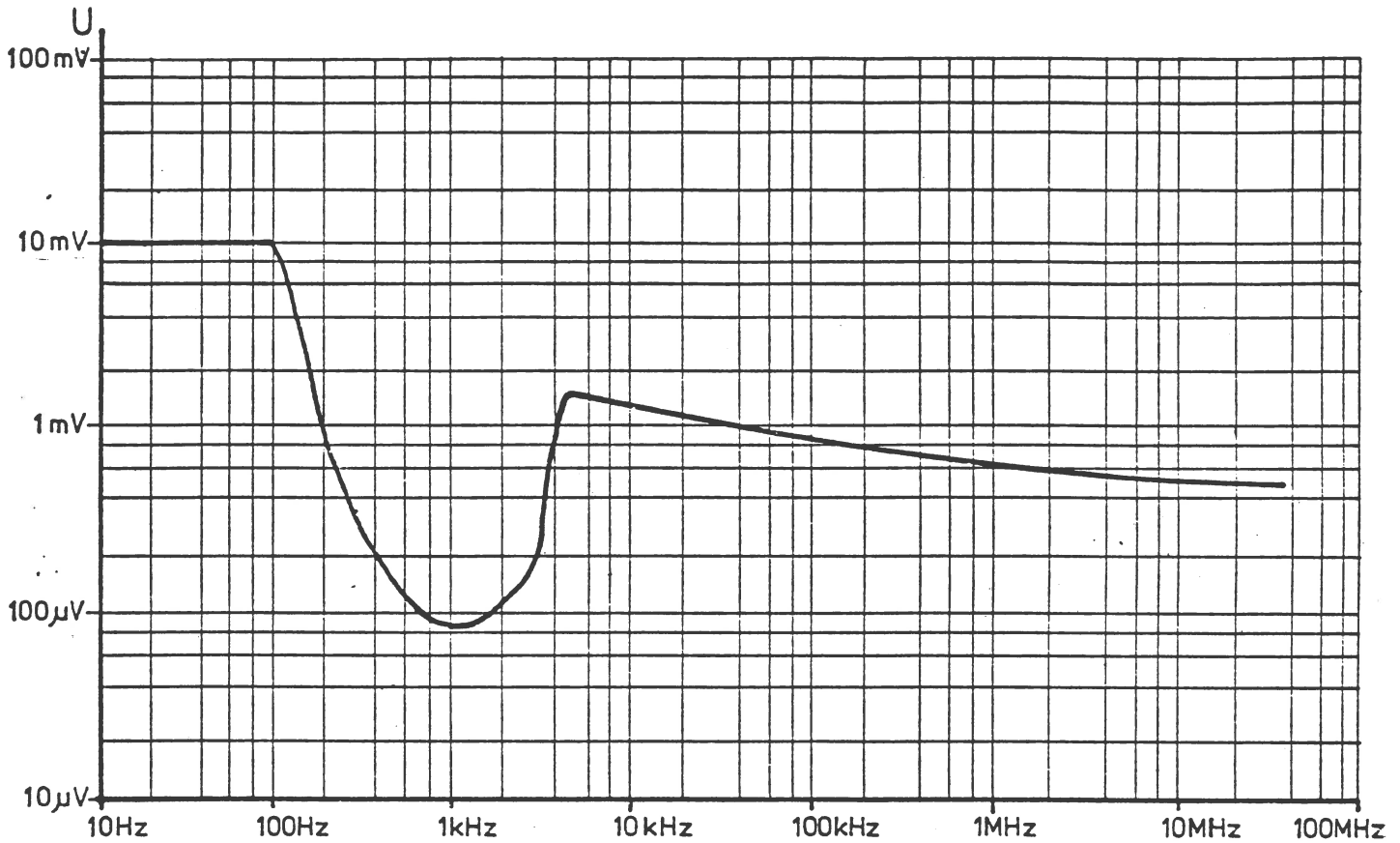

Figure 6 Spectral distribution of the maximum allowed noise from individual equipment units except the rectifier on the battery supply terminals of the unit.

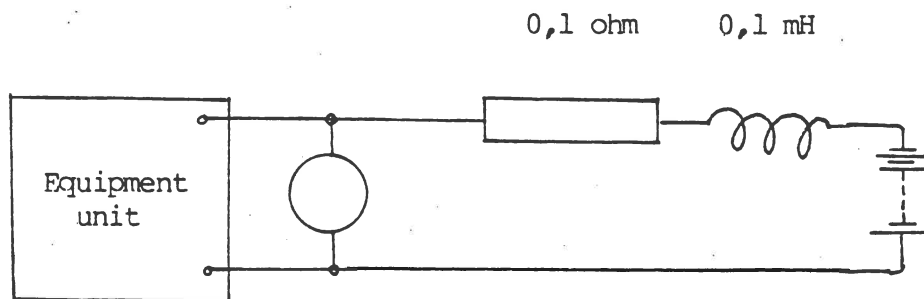

Fig. 7 Measuring arrangement for the measurement of noise from individual equipment units except the rectifier

1.3.17 Hysteresious function of DC-power supply

To protect against undesired functions at battery discharging the power supply shall have the hysteresious stated below:

41 V + 2 V for switch off and

46 V + 1 V for switch on.

2 TEST CONDITIONS

2.1 POWER SOURCES AND AMBIENT TEMPERATURES

2.1.1 Application of test conditions

The test conditions and procedures shall be as specified in 2.1.2 to 2.1.5.

2.1.2 Test power source

During the tests the power source of the equipment shall be replaced by a test power source, capable of producing normal and extreme test voltages as specified in 2.1.3.2 and 2.1.4.2.

The internal impedance of the test power source shall be low enough for its effect on the test results to be negligible. For the purpose of tests, the voltage of the power source shall be measured at the input terminals of the equipment. During the tests, the power source voltage shall be maintained within a tolerance of +3% relative to the voltage at the beginning of each test.

2.1.3 Normal test conditions

2.1.3.1 Normal temperature and humidity

The normal temperature and humidity conditions for tests shall be any convenient combination of temperature and humidity within the following ranges:

Temperature +15°C to +35°C  
Relative humidity 20% to 75%

2.1.3.2 Normal test power source

2.1.3.2.1 Mains voltage

The normal test voltage for equipment to be connected to the mains shall be 220 V, 50 Hz +1 Hz.

2.1.3.2.2 Battery power source with buffer

The normal test voltage for equipment to be supplied from a DC-power source shall be 53 V, positive pole grounded.

2.1.4 Extreme test conditions

2.1.4.1 Extreme temperatures

For tests at extreme temperatures, measurements shall be made in accordance with the procedures specified in Clause 2.1.5 at the temperatures of  $-10^{\circ}\text{C}$  and  $+55^{\circ}\text{C}$ .

2.1.4.2 Extreme test voltage

2.1.4.2.1 Mains voltage

The extreme test voltage for equipment to be connected to the AC-mains source shall be the upper and lower limits of 220 V  $\pm 10\%$ .

2.1.4.2.2 Battery power source with buffer

The extreme test voltage for equipment to be connected to a DC-power source shall be 63 V and 43 V, positive pole grounded.

2.1.5 Procedure for tests at extreme temperatures

Before measurements are made the equipment shall have reached thermal balance in the test chamber. The equipment shall be in continuous operation (transmit or receive condition, respectively).

If the thermal balance is not checked by measurements, a temperature stabilizing period of at least one hour, or such period as may be decided by the testing authority, shall be allowed. The sequence of measurements shall be chosen, and the humidity content in the test chamber shall be controlled so that excessive condensation does not occur.

2.2 GENERAL CONDITIONS

2.2.1 Continuous operation

The base station equipment shall be designed for continuous operation (transmit or receive condition, respectively). In connection with acceptance test and before measurements are made, a continuous operation test of 200 hours at normal test condition is foreseen.

2.2.2 Artificial antenna

Tests on the transmitter and transmitter combiner shall be carried out with a non-reactive non-radiating load of 50 ohms connected to the antenna terminals.

### 2.2.3 Arrangements for test signals at the line input of the transmitter

The transmitter audio-frequency modulation signal shall be supplied by a generator connected to the line input. The nominal impedance of the line input circuit shall be 600 ohms resistive.

### 2.2.4 Modulation

#### 2.2.4.1 Normal test modulation

For normal test modulation, the modulation frequency shall be 1,0 kHz and the resulting peak to peak frequency deviation shall be +3,0 kHz. The test signal shall be substantially free from amplitude modulation.

#### 2.2.4.2 Normal data test modulation

Normal data test modulation is defined as the carrier frequency modulated with idle frames (6 or 15), see NMT Doc. 1 to give a mean peak to peak frequency deviation of +3,5 kHz. This corresponds to actual measured peak deviation (1800 Hz tone) of 4,2 kHz.

The audio level for the datasignal is thus -2,2 dB below the audio level for 1000 Hz tone to give normal test modulation of +3,0 kHz.

### 2.2.5 Arrangements for test signals applied to the receiver input

Sources of test signals for application to the receiver input shall be connected in such a way that the impedance presented to the receiver input is 50 ohms.

This requirement shall be met irrespective of whether one or more signals are applied to the receiver simultaneously.

The levels of the test signals shall be expressed in terms of the E.M.F. at the receiver input terminals.

The effects of any intermodulation products and noise produced in the signal generators should be negligible.

### 2.2.6 Psophometric filter

The psophometric filter, which is used in some of the test measurements, shall fulfil the requirements specified in CCITT Recommendation P.53A (Psophometer for Commercial Telephone Circuits).

### 2.2.7 Receiver squelch circuit

The receiver squelch circuit shall be made inoperative for the duration of the tests (with exception for the tests concerning the squelch circuit itself).



## 2.2.8 Test site and general arrangements for measurements involving the use of radiated fields

### 2.2.8.1 Test site

The test site shall be on a reasonably level surface or ground.

At one point on the site, a ground plane of at least 5 metres diameter shall be provided. In the middle of this ground plane, a non-conducting support, capable of rotation through 360° in the horizontal plane, shall be used to support the test sample at 1.5 metres above the ground plane. The test site shall be large enough to allow the erection of a measuring or transmitting antenna at a distance of  $\lambda/2$  or 3 metres whichever is the greater. The distance actually used shall be recorded with the results of the test carried out on the site.

Sufficient precautions shall be taken to ensure that reflections from extraneous objects adjacent to the site and ground reflections do not degrade the measurement results.

### 2.2.8.2 Test antenna

The test antenna is used to detect the radiation from both the test sample and the substitution antenna, when the site is used for radiation measurements; where necessary, it is used as a transmitting antenna, when the site is used for the measurement of receiver characteristics. This antenna is mounted on a support such as to allow the antenna to be used in either horizontal or vertical polarization and for the height of its centre above ground to be varied over the range 1 - 4 metres. Preferably test antenna with pronounced directivity should be used. The size of the test antenna along the measurement axis shall not exceed 20% of the measuring distance.

For radiation measurements, the test antenna is connected to a test receiver, capable of being tuned to any frequency under investigation and of measuring accurately the relative levels of signals at its input. When necessary (for receiver measurements) the test receiver is replaced by a signal source.

### 2.2.8.3 Substitution antenna

The substitution antenna shall be a  $\lambda/2$  dipole, resonant at the frequency under consideration, or a shortened dipole, calibrated to the  $\lambda/2$  dipole. The centre of this antenna shall coincide with the reference point of the test sample it has replaced. This reference point shall be the volume centre of the sample when its antenna is mounted inside the cabinet, or the point where an external antenna is connected to the cabinet.

The distance between the lower extremity of the dipole and the ground shall be at least 30 cm.

The substitution antenna shall be connected to a calibrated signal generator when the site is used for radiation measurements and to a calibrated measuring receiver characteristics. The signal generator and the receiver shall be operating at the frequencies under investigation and shall be connected to the antenna through suitable matching and balancing networks.

2.2.8.4 Alternative indoor site

When the frequency of the signals being measured is greater than 80 MHz, use may be made of an indoor site. If this alternative site is used, this shall be recorded in the test report.

The measurement site may be a laboratory room with a minimum area of 6 metres by 7 metres and at least 2,7 metres in height.

Apart from the measuring apparatus and the operator, the room shall be as free as possible from reflecting objects other than the walls, floor and ceiling.

The site arrangement is in principle shown in Fig. 8.

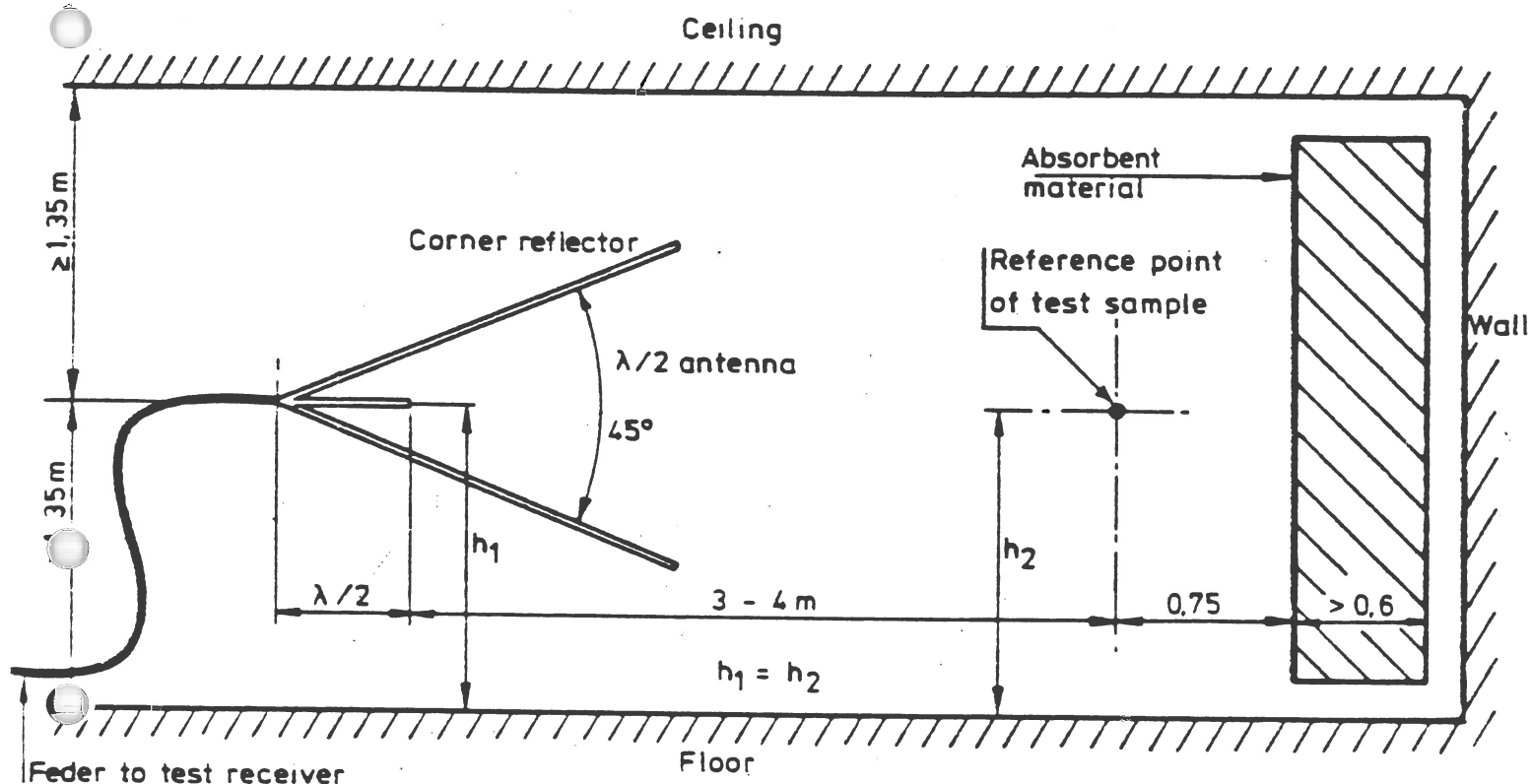

FIGURE 8

Indoor site arrangement  
(shown for horizontal polarization)

The potential reflections from the wall behind the equipment under test are reduced by placing a barrier of absorbent material in front of it. The corner reflector around the test antenna is used to reduce the effect of reflections from the opposite wall and from the floor and ceiling in the case of horizontally polarized measurements.

Similarly, the corner reflector reduces the effects of reflections from the side walls for vertically polarized measurements.

For the lower part of the frequency range (below appr. 175 MHz) no corner reflector or absorbent barrier is needed.

For practical reasons, the  $\lambda/2$  antenna in Fig. 1 may be replaced by an antenna of constant length, allowing it to be used at frequencies corresponding to a length between  $\lambda/2$  and  $\lambda$ , as long as the sensitivity is sufficient. In the same way the distance of  $\lambda/2$  to the apex may be varied.

The test antenna, test receiver, substitution antenna and calibrated signal generator are used in a way similar to that of the general method.

To ensure that errors are not caused by the propagation path approaching the point at which phase cancellation between direct and the remaining reflected signals occurs, the substitution antenna shall be moved through a distance of +10 cm in the direction of the test antenna as well as in the two directions perpendicular to this first direction. If these changes of distance cause a signal change of greater than 2 dB, the test sample should be resited until a change of less than 2 dB is obtained.

2.3 ACCURACY AT MEASUREMENTS

2.3.1	<u>D.C. voltage</u>	<u>+1%</u>
2.3.2	<u>A.C. mains voltage</u>	<u>+3%</u>
2.3.3	<u>A.C. mains frequency</u>	<u>+0,5%</u>
2.3.4	<u>Audio-frequency voltage, power, etc.</u>	<u>+0,5%</u>
2.3.5	<u>Audio-frequency</u>	<u>+0,1%</u>
2.3.6	<u>Distortion and noise, etc. of audio frequency generators</u>	<u>+0,5%</u>
2.3.7	<u>Radio frequency</u>	<u>+20 Hz</u>
2.3.8	<u>Radio-frequency voltage</u>	<u>+2 dB</u>
2.3.9	<u>Radio-frequency field strength</u>	<u>+3 dB</u>
2.3.10	<u>Radio-frequency carrier power</u>	<u>+5%</u>
2.3.11	<u>Impedance of artificial loads, combining units, cable, plugs, attenuators, etc.</u>	<u>+5%</u>
2.3.12	<u>Source impedance of generators and input impedance of measuring receivers</u>	<u>+10%</u>
2.3.13	<u>Attenuation by attenuators</u>	<u>+0,5 dB</u>
2.3.14	<u>Temperature</u>	<u>+1°C</u>
2.3.15	<u>Humidity</u>	<u>+5%</u>

### 3 COMBINING EQUIPMENT

A calculation of some critical parameters in the combining equipment in relation to the transmitter/receiver-requirements in clause 4 and 5 is given in Annex 1.

#### 3.1 TRANSMITTER COMBINER

This clause states the minimum performance requirements for a transmitter combining equipment, the purpose of which is to connect a number of radio transmitters to a common antenna.

##### 3.1.1 Number of transmitters

The equipment shall permit the simultaneous connection of up to at least 8 transmitters. The requirements of this clause shall be fulfilled for any number, from 1 to at least 8, of transmitters being connected to the transmitter combiner and being in operation or not.

##### 3.1.2 Frequency range

The frequency range shall be at least 463,000 - 467,500 MHz.

##### 3.1.3 Frequency separation

The combiner shall be able to combine transmitters with a frequency separation down to 175 kHz. It is however desired that the combiner is designed in such a way that no restrictions are made on the transmitter frequency separation.

##### 3.1.4 Input and output impedances

The nominal input and output impedances shall be 50 ohms non-symmetric.

##### 3.1.5 Voltage standing wave ratio (VSWR)

The voltage standing wave ratio (VSWR) at the output terminal (antenna-terminal) shall not exceed 1,5 and at all input terminals not exceed 1,3. At extreme test conditions the VSWR shall not exceed 1,8 at the output terminal and 1,5 at the input terminals.

##### 3.1.6 Connectors

The connectors at the inputs shall be of type N (female). The output connector shall be of type 7/16 (female).

##### 3.1.7 Carrier power

The maximum carrier power available from each transmitter to be connected to the combiner inputs in 50 W + 1 dB according to clause 4.4.

- If the combiner is designed as a passive network the power loss from any one of the input terminals to the output terminal shall not exceed 3,5 dB at normal test conditions and 4,5 dB at extreme test conditions.
- In case of an active combiner the power of each individual carrier measured at the output terminal of the combiner shall not be less than -3,5 dB to 50 W. At extreme test conditions the power shall not differ more than +1 dB relative to the power at normal test conditions.

### 3.1.8 Load test

Transmitters shall be simultaneously applied at all the input terminals of the combiner, each transmitter having an output corresponding to the specified carrier power at the output terminal of the combiner according to clause 3.1.7.

- The transmitter combiner shall then be submitted to a load test with continuous transmission for a period of 2 hours. The change in the carrier power at the output terminal shall not exceed 2 dB during the load test when the output terminal is loaded with a resistive impedance giving a VSWR of 2. The test shall be carried out at normal test conditions.
- Furthermore the equipment shall be capable of withstanding, without being damaged, a load test when the output terminal of the combiner is loaded with an arbitrary load, including short circuit or open circuit at the output terminal for a period of 30 minutes.

### 3.1.9 Intermodulation attenuation

The power of any intermodulation product generated by the simultaneously applied transmitters connected to the input terminals of the equipment shall be attenuated at least  $55 \text{ dB} + A_T$  below each transmitter carrier power as measured at the input terminal of the combiner.  $A_T$  is the intermodulation attenuation for the transmitters connected to the combiner inputs. (See clause 3.1.12 and 4.7)

In case of an active combiner, the power of any intermodulation product shall not exceed -70 dB relative to each transmitter power at the combiner output except for the 5th order intermodulation products within the frequency band 453,0 to 457,5 MHz which to each transmitter carrier power as measured at the combiner output, and shall further be attenuated as stated in clause 3.1.12.

### 3.1.10 Spurious emissions

The power of any spurious emissions, except for intermodulation products as specified in paragraph 3.1.9, generated in the transmitter combiner (circulators, amplifiers etc.) shall not exceed 0,25  $\mu\text{W}$  at normal test conditions and 1,0  $\mu\text{W}$  at extreme conditions. The definition and method of measurements are in accordance with clause 4.6.

3.1.11 Noise power within receiver channel

In case of an active combiner the noise power within any receiver channel, measured at the output of the internal amplifier, shall not exceed 2 nW.

The definition and method of measurements are in accordance with clause 4.12.

3.1.12 Attenuation within the receiver frequency band

The combiner shall provide an attenuation not less than 45 dB within the frequency band 453,000 to 457,500 MHz, measured between any combiner input terminal and the combiner output terminal.

In case of an active combiner, the attenuation shall be measured between any amplifier output and the combiner output.

This attenuation is in addition to the requirements specified in paragraph 3.1.9, 3.1.10 and 3.1.11.

3.1.13 Test features

The transmitter combiner shall be provided with instruments for reading carrier power at the output terminal, and reflected power from the antenna.

If active components are used in the combiner, fault alarms such as power failure shall be given to the control unit (CU).

Furthermore the transmitter combiner shall give fault alarm (two levels) to the control unit at unallowable high standing wave ratio at the output of the combiner (antenna fault). The settings for antenna fault alarms shall be adjustable between VSWR 1,2 and 2,0. The VSWR alarm level shall not vary more than +10% from the setting level within the transmitter frequency band.

3.1.14 Interface between transmitter combiner and control unit

The alarm output from transmitter combiner shall be connected to the control units (CU) by three wires. One of the wires shall be a common return wire and it may be connected to ground in the radio equipment cabinet. The alarms shall be given by closing relay circuits. In the table of signals below closed circuit in transmitter combiner is indicated by one (1) and an open circuit by zero (0).

Transmitter combiner alarm	code
no alarm	00
level 1	01
level 2	11

It shall be possible to connect up to ten control units to a transmitter combiner alarm circuit.

3.1.15 Power supply to alarm circuits in transmitter combiner

The power supply voltage to the combiner shall be either +14 V +2 V or +24 V +2 V. The current consumption shall not exceed 170 mA. This power shall be supplied from the radio equipment cabinet.

3.2 RECEIVER MULTICOUPLER

3.2.1 Number of receivers

The equipment shall permit connection of up to at least 10 receivers. The requirements of this specification shall be fulfilled for any number, from 1 to at least 10 receivers connected.

3.2.2 Frequency range

The frequency range shall be at least 453,000 - 457,500 MHz.

3.2.3 Input and output impedances

The nominal input and output impedances shall be 50 ohms non-symmetric.

3.2.4 Voltage standing wave ratio (VSWR)

The VSWR shall not exceed 1,5 at all terminals at normal test conditions and 1,8 at extreme test conditions.

3.2.5 Connectors

The connectors at all terminals shall be of type N (female).

### 3.2.6 Input filter

The receiver multicoupler shall be provided at the input with a filter which has an attenuation characteristics as shown below.

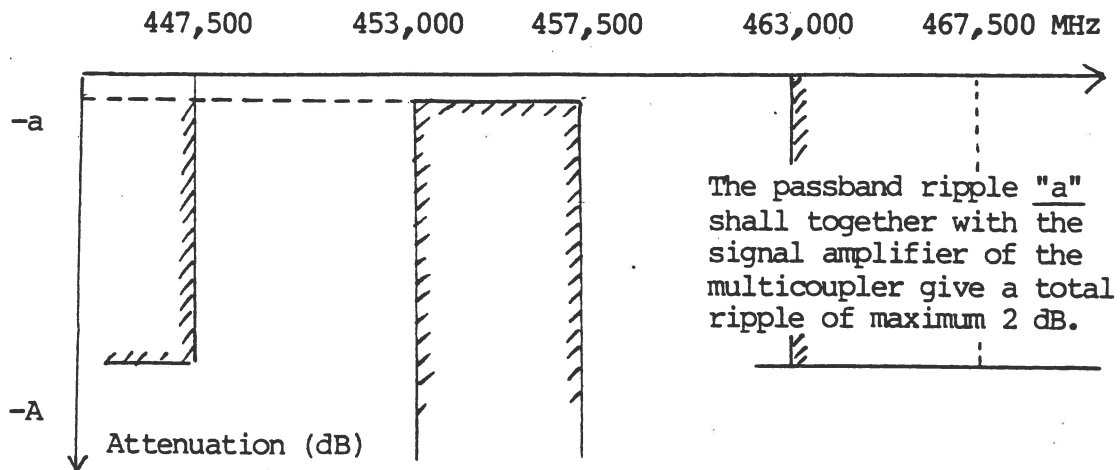

A is equal to -60 dB at normal test conditions and -55 dB at extreme test conditions.

### 3.2.7 Net gain in the passband

The net gain from the input terminal to any one of the multicoupler output terminals shall be  $1 \pm 1$  dB within the frequency range specified in paragraph 3.2.2.

### 3.2.8 Isolation between multicoupler outputs

The isolation between arbitrary multicoupler outputs shall not be less than 25 dB.

### 3.2.9 Noise factor

The noise factor for the multicoupler shall not exceed 6 dB.

### 3.2.10 Intermodulation

Intermodulation products of odd orders, generated from two input signals within the filter's passband with the level 95 dB (1  $\mu$ V) E.M.F., shall not exceed -60 dB relative to the level of each disturbing signal at the multicoupler output.

### 3.2.11 Blocking

#### 3.2.11.1 Definition:

The blocking of the receiver multicoupler denotes the ability of the multicoupler to distribute a low level signal in the presence of a high level signal.



## 3.2.11.2 Method of measurements:

Two signal generators are connected to the input terminal of the receiver multicoupler. The frequency of the two signals shall be within the frequency range specified in paragraph 3.2.2.

- a) The level of the first test signal shall be set to 20 dB (1  $\mu$ V)E.M.F. The level at the output of the multicoupler shall be measured using a measuring receiver tuned to the frequency of the signal.
- b) Thereafter the level of the first test signal shall be increased by 3 dB.
- c) The level of the second test signal shall then be increased until the level of the first test signal at the output of the multicoupler (and at the input of the measuring receiver) has been decreased to the same level as measured according a) above.
- d) The level of the second test signal at the input of the multicoupler shall be measured.

## 3.2.11.3 Requirements:

The level of the second test signal shall not be less than 110 dB (1  $\mu$ V)E.M.F.

3.2.12 Ability to withstand overvoltage

The receiver multicoupler shall withstand without being damaged a continuous input voltage of 2 V E.M.F. within the frequency range specified in paragraph 3.2.2.

3.2.13 Susceptibility to the output terminals not in use

The requirements of clause 3.2 shall be fulfilled irrespective of whether output terminals not in use are terminated with a load or not.

3.2.14 Test failures

The receiver multicoupler shall give fault alarm to the control unit (CU) in case of power failure or amplifier failure.

3.2.15 RF test loop input

The receiver multicoupler shall be provided with an input terminal for connection to RF test loop. See also chapter 10.

## 3.3 DUPLEX - FILTER (70 W)

3.3.1 Frequency range

Transmitter 463,000 - 467,500 MHz

Receiver 453,000 - 457,500 MHz.

3.3.2 Duplex-separation

The separation between the transmit and receive frequencies for a particular channel is 10 MHz.

3.3.3 Duplex-filter bandwidth

The bandwidth corresponding to the insertion loss specified in clause 3.3.8 and 3.3.10 shall not be less than 4,5 MHz.

3.3.4 Input and output impedances

The nominal input and output impedances shall be 50 ohms non-symmetric.

3.3.5 Voltage standing wave ratio (VSWR)

The voltage standing wave ratio shall not exceed 1,3 at all terminals at normal test conditions and 1,5 at extreme test conditions.

At the measurement of standing wave ratio of one terminal, the other two terminals shall be connected to a resistive load of 50 ohms.

3.3.6 Connectors

The connectors at all terminals shall be of type N (female).

3.3.7 Carrier power capability

The duplex-filter shall be able to handle at least 70 W carrier power at the transmitter input.

3.3.8 Attenuation in the transmitter branch

The attenuation in the transmitter branch (transmitter input to antenna output) shall be in accordance with the characteristic below.

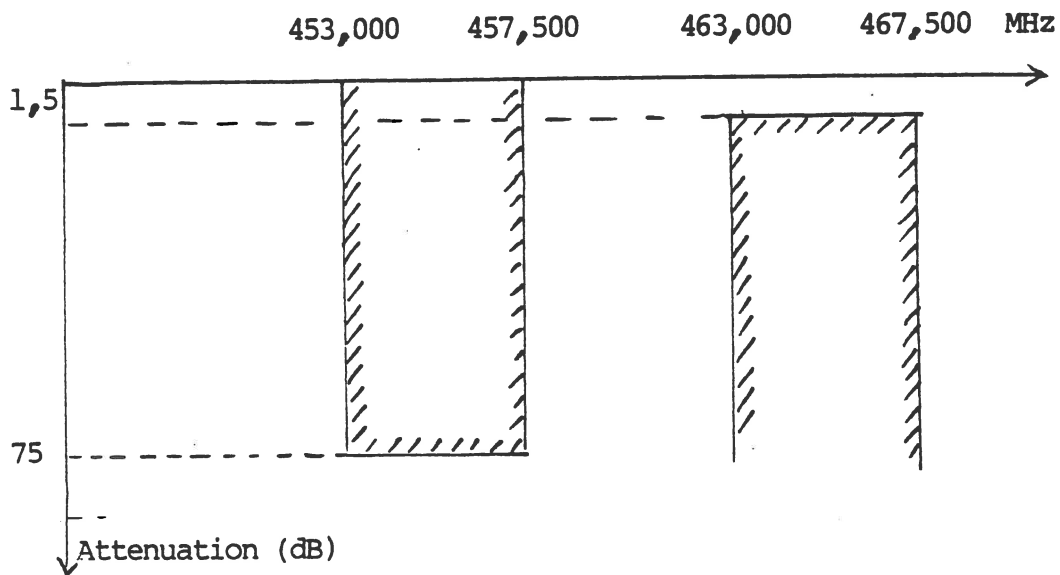

The insertion loss in the transmitter branch shall not exceed 1,5 dB within the specified transmitter range 463,000 - 467,500 MHz the insertion loss of the circulator in paragraph 3.3.9 being included. The insertion loss at extreme test conditions shall not exceed 2,0 dB.

3.3.9 Circulator in the transmitter branch

In connection with the duplex-filter a circulator is required to attenuate at least 25 dB in the direction from the antenna to the transmitter, of at least the transmitter frequency range 463,0 - 467,5 MHz.

3.3.10 Attenuation in the receiver branch

The attenuation in the receiver branch (antenna input to receiver output) shall have a bandpass characteristic as shown below.

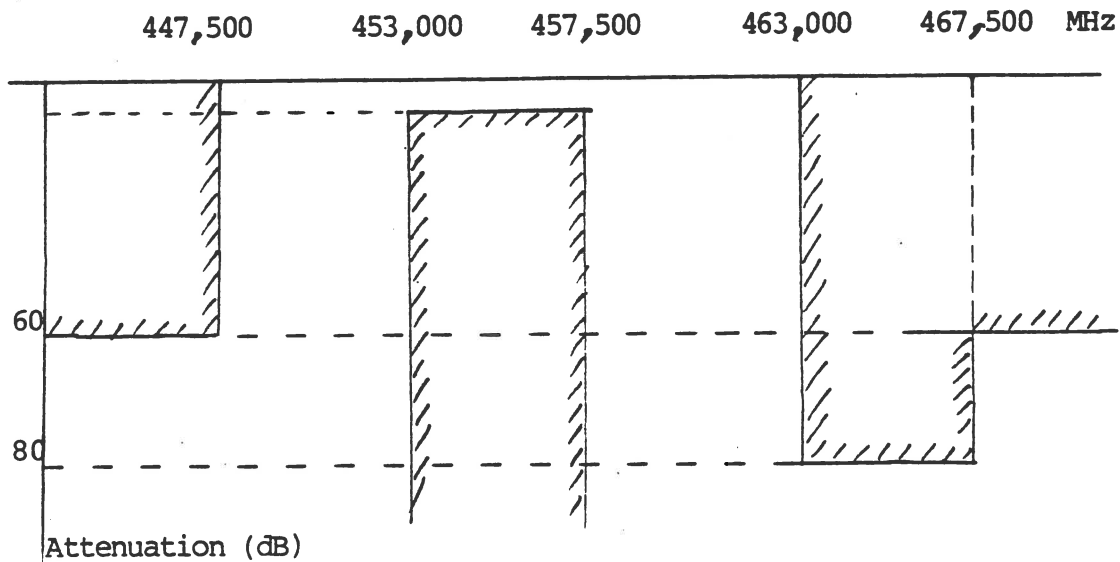

The insertion loss in the receiver branch shall not exceed 2 dB within the specified receiver range 453,000 - 457,500 MHz. The insertion loss at extreme test conditions shall not exceed 2,5 dB.

### 3.3.11 Antenna fault alarm circuit

The duplex-filter shall have the alarm circuit according to paragraph 3.1.13.

## 3.4 DUPLEX FILTER (350 W)

### 3.4.1 Frequency range

Transmitter: 463,000 - 467,500 MHz.

Receiver: 453,000 - 457,500 MHz.

### 3.4.2 Duplex separation

The separation between the transmit and receive frequencies for a particular radio channel is 10 MHz.

### 3.4.3 Duplex filter bandwidth

The bandwidth corresponding to the insertion loss specified in clauses 3.4.5 and 3.4.10 shall not be less than 4,5 MHz.

### 3.4.4 Input and output impedances

The nominal input and output impedances shall be 50 ohms non-symmetric.

3.4.5 Voltage standing wave ratio (VSWR)

The voltage standing wave ratio shall not exceed 1,3 at all terminals at normal test conditions and 1,5 at extreme test conditions.

At the measurement of standing wave ratio of one terminal, the other two terminals shall be connected to a resistive load of 50 ohms.

3.4.6 Connections

The transmitter input terminal and the antenna output terminal shall be of type 7/16 (female). The receiver output terminal shall be of type N (female).

3.4.7 Carrier power capability

The duplex filter shall be able to handle at least 350 W carrier power measured at the transmitter input terminal.

3.4.8 Attenuation in the transmitter branch

The attenuation in the transmitter branch (between transmitter input terminal and antenna output terminal) shall fulfil the requirements in the figure below.

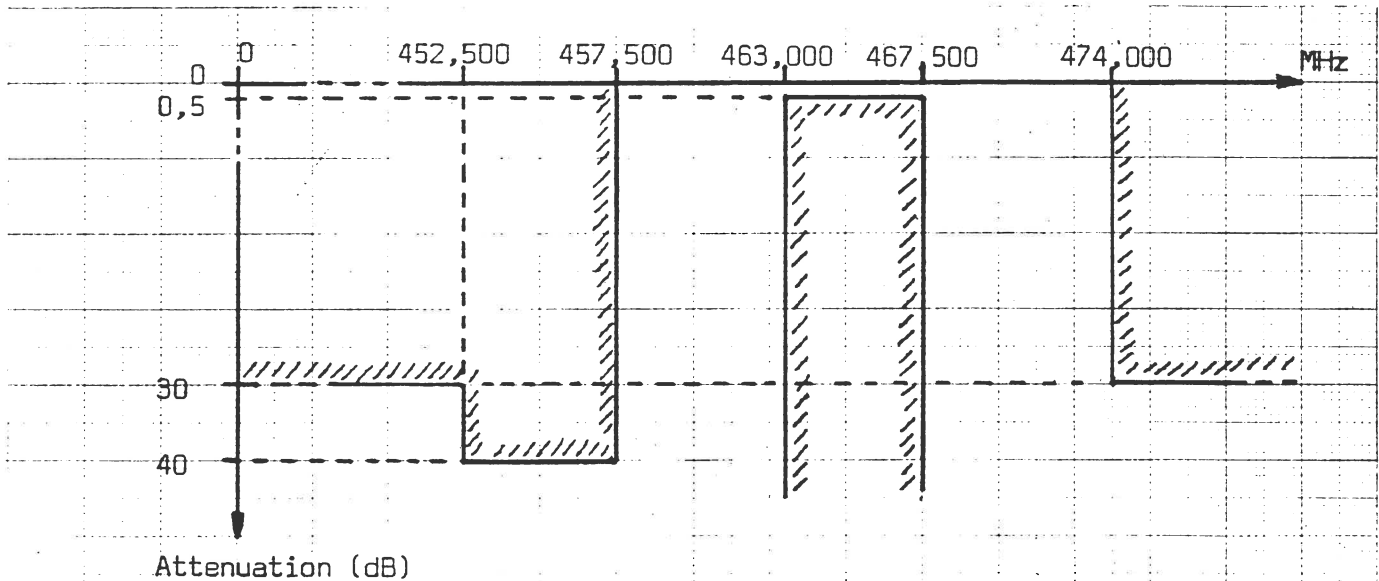

3.4.9 Attenuation between transmitter and receiver

The attenuation between transmitter input terminal and receiver output terminal shall fulfil the requirements in the figure below.

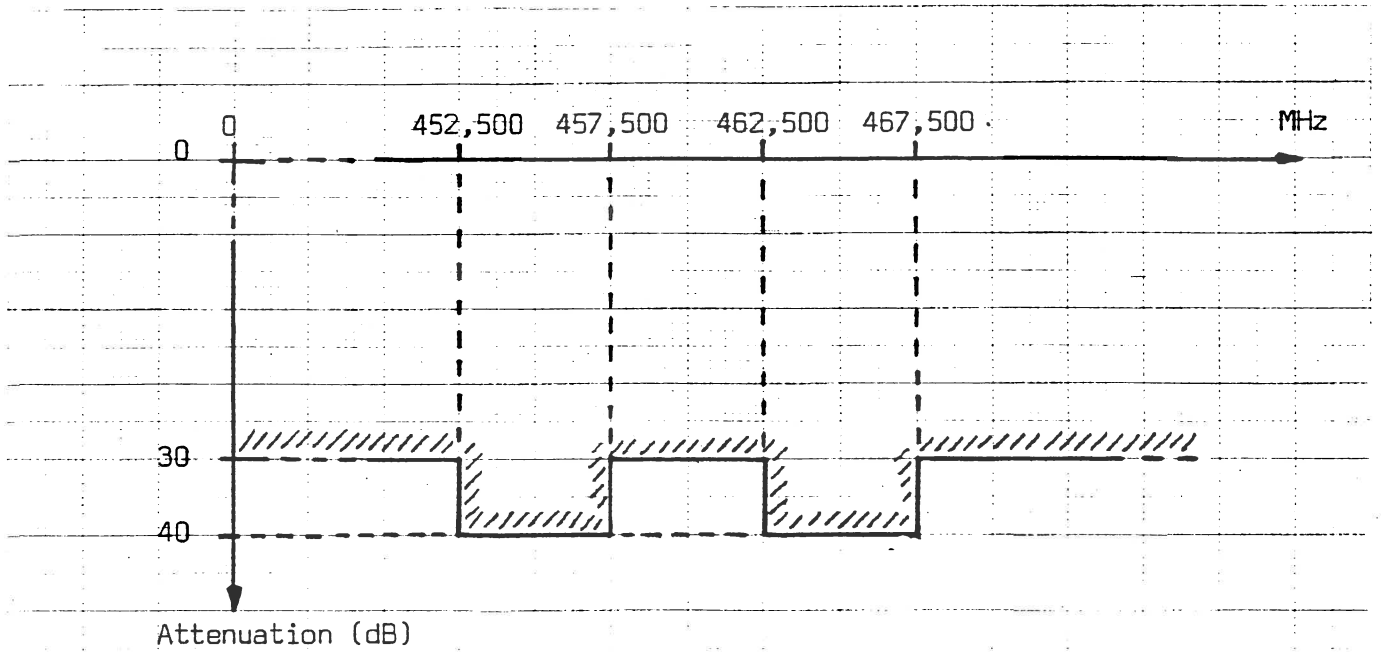

3.4.10 Attenuation in the receiver branch

The attenuation in the transmitter branch (between antenna input terminal and receiver output terminal) shall fulfil the requirements in the figure below.

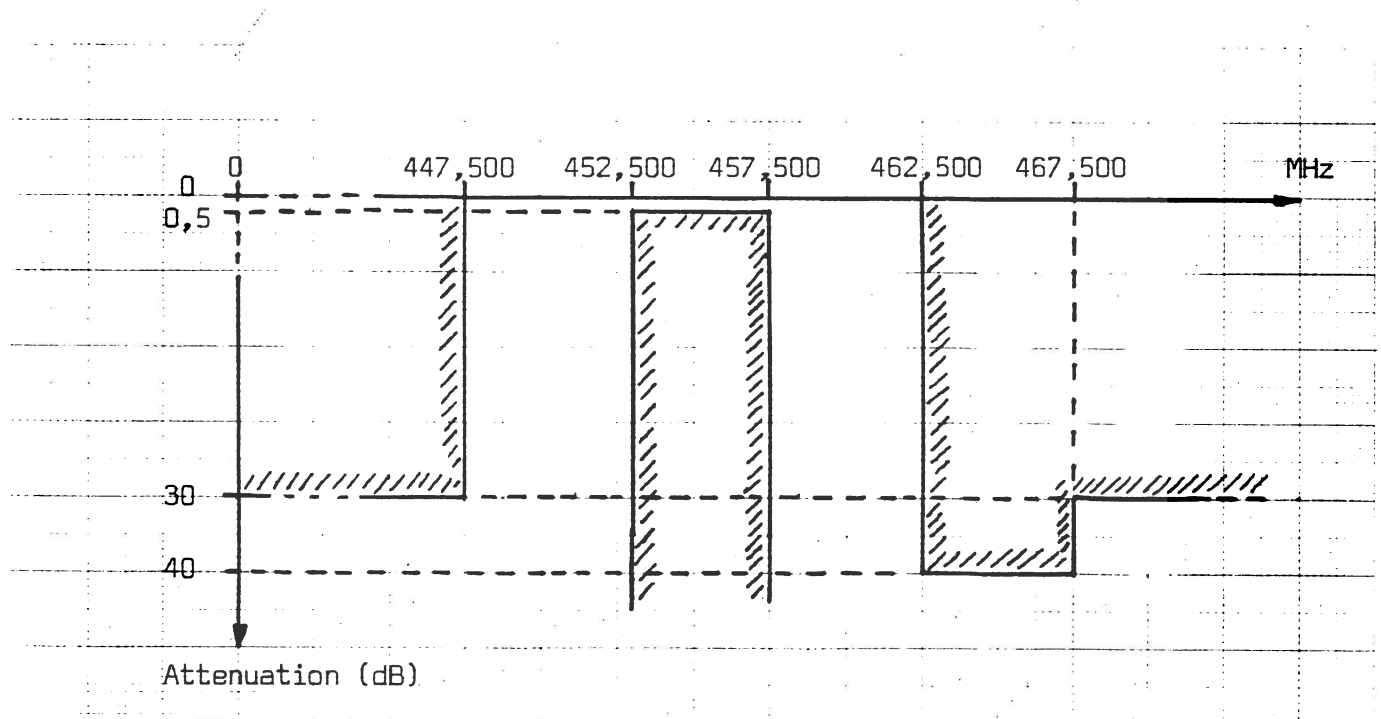

#### 3.4.11 Antenna fault alarm circuit

The duplex filter shall be provided with the alarm circuit according to paragraphs 3.1.13 to 3.1.15.

These shall be considered as functional requirements for the whole antenna combining arrangement. Therefore the alarm circuit fulfilling the functional requirements may physically be a separate unit.

#### 3.4.12 Spurious and intermodulation products emissions

In the antenna combining arrangement with 350w duplex filter including antenna fault alarm circuit, the level of the spurious emissions and intermodulation products at the receiver output terminal shall not exceed -30 dB relative to the levels stated in paragraphs 3.1.9 and 3.1.10.

## 4 TRANSMITTER

### 4.1 FREQUENCY RANGE

Transmitter frequency range shall be 463,000 - 467,475 MHz. Channel separation shall be 25 kHz.

### 4.2 NUMBER OF RF CHANNELS

The transmitter shall be capable of being set to any one of the 180 channels in the frequency range specified in clause 4.1.

The channel setting shall be possible in two different ways:

- locally by means of channel selector on the control unit (CU).
- remotely from the MTX via the control unit (CU).

The channel setting order from MTX shall override the local channel setting.

### 4.3 FREQUENCY ERROR

#### 4.3.1 Definition

The frequency error of the transmitter is the difference between the measured carrier frequency and its nominal value.

#### 4.3.2 Method of measurement

The carrier frequency shall be measured in the absence of modulation with the transmitter connected to an artificial antenna.

The measurements shall be repeated with modulation specified in clause 4.11.

#### 4.3.3 Requirements

The frequency error of the transmitter shall not exceed  $\pm 1,0$  kHz.

This requirement includes the effect of aging for a period of one year.

The amount of annual aging shall be stated by the manufacturer.

This requirement shall be fulfilled also during the carrier rise time and decay time specified in clause 4.5.



4.4 RF-CARRIER POWER

4.4.1 Definition

The transmitter carrier power is the mean power delivered to the artificial antenna during a radio frequency cycle, without modulation.

4.4.2 Method of measurement

The transmitter shall be connected to an artificial antenna and the power delivered to this artificial antenna shall be measured.

4.4.3 Requirements

The nominal output power shall be 50 W into 50 ohms unbalanced.

Under normal test conditions and independent of selected channel the carrier output power shall be within +1,0 dB of the nominal output power.

Under extreme test conditions the carrier output power shall be within +1 dB and -2 dB of the nominal output power.

4.4.4 Load test

The transmitter shall be submitted to load tests, continuous transmission, for a period of 2 hours.

- The change in the transmitter output power shall not exceed 2 dB during a load test when the transmitter is loaded with resistive impedance at the output terminal giving a voltage standing wave ratio (VSWR) of 2. The test shall be carried out at normal test conditions.
- Without being damaged, the equipment shall be able to withstand a load test when the transmitter is loaded with a resistive impedance giving a voltage standing wave ratio of 2. The test shall be carried out at extreme test conditions.

Furthermore the equipment shall be capable of withstanding, without being damaged, a load test when the transmitter is loaded with an arbitrary load, including short circuit or open circuit at the output terminal for at least one minute.

4.5 CARRIER ON/OFF CONDITION AND CARRIER RISE/DELAY TIME

4.5.1 Definition

Carrier off conditions: Transmitter output power below 0,25  $\mu$ W.

Carrier on conditions: Transmitter output power within 2 dB relative to the steady-state output power value.

- Carrier rise time: Elapsed time between the end of the control signal start transmitter from the MTX and the moment the carrier on condition is obtained.
- Carrier decay time: Elapsed time between the end of the control signal stop transmitter from the MTX and the moment carrier off condition is obtained.

#### 4.5.2 Method of measurement

The carrier rise time and the carrier decay time.

The transmitter shall be connected to an artificial antenna. The time elapsed from the end of received frame 20 A(15) to the moment the transmitter has reached the carrier on condition is measured.

The time elapsed from the end of received frame 20 A(0) to the moment the transmitter has reached the carrier off conditions is measured.

#### 4.5.3 Requirements

In the carrier off condition, the carrier output power shall not exceed 0,25  $\mu$ W.

The carrier rise time shall not exceed 138 ms measured from the end of the order frame.

### 4.6 SPURIOUS EMISSIONS

#### 4.6.1 Definition

Spurious emissions are emissions at frequencies other than those of the carrier and sidebands associated with normal modulation.

The level of spurious emissions shall be measured as:

- their conducted power in an artificial antenna and
- their effective radiated power when radiated by the cabinet and structure of the equipment (also called "cabinet radiation").

#### 4.6.2 Method of measuring conducted over level

Conducted spurious emissions shall be measured as the power of and discrete signal delivered into a 50 ohms load. This may be done by connecting the transmitter output through an attenuator to a spectrum analyser or selective voltmeter, or by monitoring the relative levels of the spurious signals delivered to an artificial antenna.

- a) The transmitter shall be unmodulated and the measurements made over at least the frequency range 100 kHz to 2000 MHz except for the channel on which the transmitter is intended to operate and its adjacent channels.

- b) The measurements shall be repeated with the transmitter modulated with normal test modulation and the transmitter connected to a load with VSWR = 2.

The phase angle of the load impedance shall be varied in the range  $0^\circ - 360^\circ$  at the carrier frequency.

- c) The measurements in case a) shall be repeated in the carrier off condition.

#### 4.6.3 Method of measuring the effective radiated power

- a) On a test site, fulfilling the requirements of paragraph 2.2.8, the sample shall be placed at the specified height on a nonconducting support. The transmitter shall be operated without modulation at the carrier power specified in paragraph 4.4.3, delivered to an artificial antenna.

Radiation of any spurious components shall be detected by the test antenna and receiver, over at least the frequency range 30 - 2000 MHz, except for the channel on which the transmitter is intended to operate and its adjacent channels. At each frequency at which a component is detected, the transmitter shall be rotated to obtain maximum response and the effective radiated power of that component determined by a substitution measurement.

The measurements shall be repeated with the test antenna in the orthogonal polarisation plane.

- b) The measurements shall be repeated with the transmitter modulated by normal test modulation.
- c) The measurements in case a) shall be repeated in the carrier off condition.

#### 4.6.4 Requirements

For cases a) and b) the power of any spurious emission in the specified range of frequencies shall not exceed  $0,25 \mu\text{W}$ , except on the second adjacent channel ( $\pm 50 \text{ kHz}$ ) where the spurious emission shall not exceed  $1,0 \mu\text{W}$ . At extreme test conditions the spurious emission shall not exceed  $1,0 \mu\text{W}$  including second adjacent channel.

For case c) the spurious emission shall not exceed  $2,0 \mu\text{W}$ .

### 4.7 INTERMODULATION ATTENUATION

#### 4.7.1 Definition

For the purpose of this specification the intermodulation attenuation is a measure of the capacity of a transmitter to inhibit the generation of signals in its non-linear elements caused by the presence of the carrier and an interfering signal reaching the transmitter via its antenna.

4.7.2 Method of measurement

The output of the transmitter under test shall be connected to a signal source via a coupling device, presenting to the transmitter a load with an impedance of 50 ohms.

The coupling device can consist of a circulator, one port of which is to be connected by a coaxial cable to the output terminal of the transmitter, the second port is to be correctly terminated (nominal value 50 ohms). This termination is to be provided with means for connection to a selective measuring device (e.g. a spectrum analyser). The third port of the circulator is to be connected to the test signal source by means of an isolator.

Alternatively, the coupling device may consist of a resistive attenuator, which may be combined with an isolator, one end to be connected to the output terminal of the transmitter by coaxial cable and the other end to be connected to the test signal source. A selective measuring device is to be connected to the transmitter end of the attenuator by means of a sampling probe, giving the required attenuation.

The transmitter under test and the test signal source shall be physically separated in such a way that the measurement is not influenced by direct radiation. The test signal shall be unmodulated and the frequency shall be within 1 - 7 neighbouring channels above the frequency of the transmitter under test. The frequency shall be chosen in such a way that the intermodulation components to be measured do not coincide with other spurious emissions. The test signal power level shall be adjusted to -30 dB relative to the carrier power level of the transmitter, both levels being measured at the output of the transmitter. The power level of the test signal shall be measured at the transmitter end of the coaxial cable, when disconnected from the transmitter and then correctly matched (nominal value 50 ohms).

The output power of the transmitter shall be measured directly at the output terminal connected to an artificial antenna.

With the transmitter switched on in an unmodulated condition the levels of the transmitter carrier and the intermodulation components are compared by means of the selective measuring device.

The length of the coaxial cable between the transmitter output and the coupling device shall be varied until the maximum level of the intermodulation component considered is obtained.

This measurement shall be repeated with the test signal at a frequency within 1 - 7 neighbouring channels below the transmitter frequency.

The measurement shall be repeated with the transmitter frequency and the test signal frequency selected in such a way that 5th order component will be the receiver frequency band (453,000 - 457,475).

When the above measurements are performed, precautions must be taken, so that non-linearities in the selective measuring device do not influence the results appreciably. Furthermore it should be ensured that intermodulation components, which may be generated in

the test signal source, are sufficiently reduced, e.g. by means of a circulator.

The intermodulation attenuation is expressed as the ratio in dB of the test signal power level to the power level of an intermodulation component.

#### 4.7.3 Requirements

The intermodulation attenuation shall be at least 15 dB for any intermodulation component except for the 5th order intermodulation component within the frequency range 453,000 to 457,475 MHz which shall be attenuated by at least 40 dB.

#### 4.8 FREQUENCY DEVIATION

The frequency deviation is the maximum difference between the instantaneous frequency of the modulated radio frequency signal and the carrier frequency alone.

##### 4.8.1 Maximum permissible frequency deviation

###### 4.8.1.1 Definition

The maximum permissible frequency deviation is the maximum value of frequency deviation stipulated in these specifications.

###### 4.8.1.2 Method of measurement

The frequency deviation shall be measured at the output of the transmitter connected to an artificial antenna, by means of a deviation meter capable of measuring the maximum deviation, including that due to any harmonics and intermodulation products which may be generated in the transmitter.

The modulation frequency shall be varied. The level of the test signal at the line input shall be 20 dB above the level giving normal test modulation.

###### 4.8.1.3 Requirements

The maximum permissible frequency deviation shall be +4,7 kHz.

#### 4.9 SUPERVISORY SIGNAL INPUT CIRCUIT

A separate supervisory signal input shall be provided. The supervisory signal shall not pass through the limiter.

The supervisory signal stated in paragraph 8.1.4 (about 4000 Hz) shall give a frequency deviation of +(0,3 ± 0,03) kHz.

#### 4.10 LIMITING CHARACTERISTIC OF THE MODULATOR (INCLUDING LINE INPUT CIRCUIT)

##### 4.10.1 Definition

The limiting characteristic of the modulator expresses the transmitter's capability of being modulated to a frequency deviation close to the maximum permissible frequency deviation as defined in paragraph 4.8.1.

##### 4.10.2 Method of measurement

A test signal with a frequency of 1000 Hz shall be applied to the line input circuit of the transmitter.

- a) The level shall be adjusted so that the frequency deviation is  $\pm 3,0$  kHz. The level is then increased by 6 dB and the frequency deviation is again measured.
- b) The level shall be adjusted so that the frequency deviation is  $\pm 1,0$  kHz. The level is then increased by 20 dB and the frequency is again measured.

The measurements shall be carried out under normal test conditions and extreme test conditions.

##### 4.10.3 Requirements

- a) The frequency deviation shall be at least  $\pm 4,0$  kHz.
- b) The frequency deviation shall be between  $\pm 4,3$  kHz and 4,7 kHz.

#### 4.11 CARRIER SHIFT DUE TO MODULATION

##### 4.11.1 Definition

Carrier shift due to modulation expresses symmetry of the limiter and modulator of the transmitter.

##### 4.11.2 Method of measurements

The carrier frequency of the transmitter without modulation shall be measured.

Then a signal with a frequency of 1000 Hz shall be applied to the line input circuit of the transmitter. The level shall be adjusted so that the frequency deviation is  $\pm 4,0$  kHz.

The average radio frequency shall be measured again.

4.11.3 Requirements

The average value of the radio frequency shall not shift more than +200 Hz from its unmodulated value.

4.12 ADJACENT CHANNEL POWER

4.12.1 Definition

The adjacent channel power is that part of the total power output of a transmitter under defined conditions of modulation, which falls within the bandwidth of a receiver of the type normally used in the system and operating in either of the adjacent channels. This power is the sum of the mean power produced by the modulation, hum and noise of the transmitter.

4.12.2 Method of measurement

The adjacent channel power shall be measured with a power measuring receiver which conforms to paragraph 4.12.4. The transmitter shall be operated at the carrier power determined in clause 4.4. The output of the transmitter shall be linked to the input of the receiver by a connecting device such that the impedance presented to the transmitter is 50 ohms and the level at the "receiver" input is appropriate.

The transmitter shall be simultaneously modulated with a signal of 1250 Hz and the supervisory signal (4000 Hz + 0,3 kHz deviation).

The signal of 1250 Hz shall be adjusted to a level 20 dB higher than that required to produce +3,0 kHz deviation (without supervisory signal). The "receiver" shall be tuned to the nominal frequency of the transmitter and the variable attenuator in the "receiver" shall be adjusted to a value p dB such that a meter reading of the order of 5 dB above the "receiver" noise level is obtained.

The "receiver" shall then be tuned to the nominal frequency of one of the adjacent channels and the variable attenuator shall be adjusted to a value q dB such that the same meter reading is obtained.

The measurement shall be repeated with normal data test modulation (paragraph 2.2.4.2).

The ratio of adjacent channel power to carrier power is the difference between the attenuator settings p and q. The adjacent channel power is determined by applying this ratio to the carrier power.

The measurement shall be repeated for the other adjacent channel.

4.12.3 Requirements

The adjacent channel power shall not exceed a value of -70 dB relative to the carrier power of the transmitter.

4.12.4 Specifications for the power measuring receiver

The power measuring receiver shall consist of a mixer, a crystal filter, a variable attenuator, an amplifier and an r.m.s. volt meter - all connected in cascade - and a local oscillator. The local oscillator may consist of a signal generator.

The bandwidths of the filter shall be as follows:

6 dB bandwidth	16 kHz (+ 1,6 kHz)
70 dB "	35 kHz (+ 3,5 kHz)
90 dB "	50 kHz (+ 5,0 kHz)

The attenuator shall cover a minimum range of variation of 90 dB in 1 dB-steps.

The maximum error of the calibration of the attenuator shall be + 0,5 dB.

The noise factor of the amplifier shall not exceed 4 dB and its amplitude/frequency characteristic shall not vary by more than 1 dB within the 6 dB bandwidth of the crystal filter.

If the attenuation of the crystal filter is less than 90 dB outside the range specified in the second column above the amplitude/frequency of the amplifier shall be such that the resultant of the crystal filter and amplifier attenuations is not less than 90 dB.

The r.m.s. voltmeter shall indicate, at maximum deviation, the r.m.s. value on non-sinusoidal signals having a peak amplitude to r.m.s. amplitude ratio of up to at least 10. It is not necessary for the voltmeter to be calibrated.

The measuring equipment shall be such that the accuracy of the power measurements will be better than 1,5 dB even if the input level of the receiver is increased by up to 100 dB above the minimum signal level measurable.

The noise level of the local oscillator in relation to its signal level shall not exceed -90 dB in a band which is 16 kHz wide and centered on a frequency separated from the carrier by 25 kHz.

4.13 NOISE POWER WITHIN RECEIVER CHANNEL

4.13.1 Definition

The noise power within receiver channel is that part of the total power output of a transmitter, which falls within the bandwidth of a receiver of the type normally used in the system and operating within the frequency range of the receiver.

4.13.2 Methods of measurement

The receiver channel noise power shall be measured with a power measuring receiver which corresponds to paragraph 4.12.4.

The transmitter shall be operated at the carrier power determined in clause 4.4.



The output of the transmitter shall be linked to the input of the receiver in such a way that the impedance presented to the transmitter is 50 ohms and the level of the transmitter carrier, attenuated at least 55 dB by a "stop filter", is appropriate at the receiver input.

The transmitter shall be set to channel 1 (463,000 MHz) and shall be unmodulated. The "receiver" shall be tuned over the frequency range 453,000 MHz to 457,475 MHz and the noise power of the transmitter shall be measured.

The measurements shall be repeated with the transmitter set to channel 81 (465,000 MHz).

The measurements shall be repeated with the transmitter set to channel 180 (467,475 MHz).

4.13.3 Requirement

The noise power within any receiver channel shall not exceed 2,0 nW.

4.14 AUDIO FREQUENCY RESPONSE OF THE TRANSMITTER (INCLUDING LINE INPUT CIRCUIT)

4.14.1 Definition

The audio frequency response is the frequency deviation of the transmitter carrier as a function of modulation frequency at a constant level of the modulation signal.

4.14.2 Method of measurement

A modulation signal at a frequency of 1000 Hz and adjusted to such level that a frequency deviation of +1,0 kHz is obtained, is applied to the transmitter. The frequency of the modulation signal is then varied between 300 Hz and 25 kHz, its level being kept constant. The connection values of frequency deviation and modulation frequency shall be determined. The measurement shall be made without the supervisory signal.

4.14.3 Requirement

The audio frequency response shall be within the limits shown in the figure below.

Frequency deviation relative to x 1kHz at constant input level

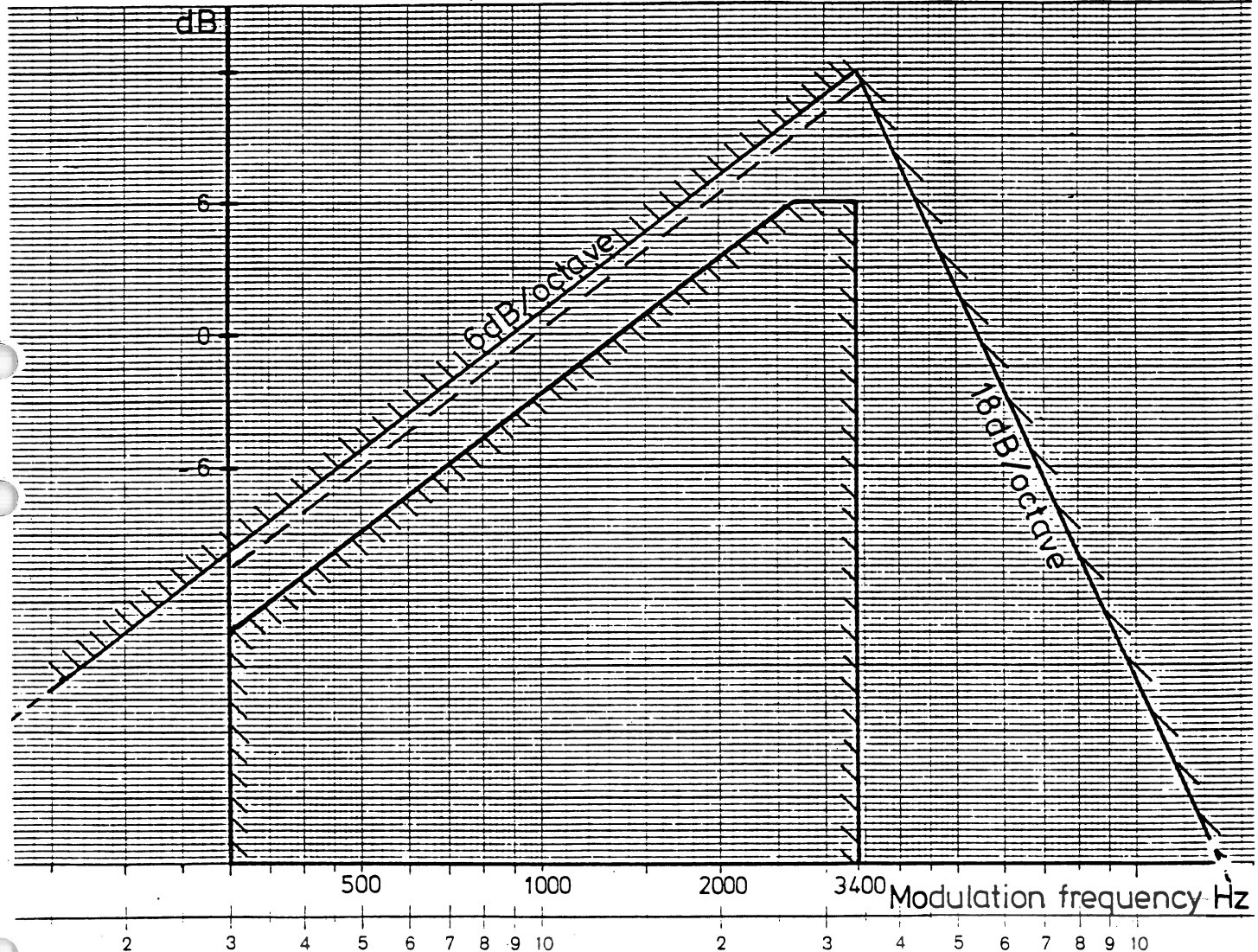

4.15 HARMONIC DISTORTION FACTOR IN TRANSMISSION

4.15.1 Definition

The harmonic distortion factor of a transmitter modulated by an audio frequency signal is defined as the ratio, expressed as a percentage, of the r.m.s. voltage of all the harmonic components of the fundamental audio frequency to the total r.m.s. voltage of the signal after linear demodulation.

With the method described below, when a distortion meter is used, the hum and noise components are included in the distortion measurement.

4.15.2 Method of measurement

The radio frequency signal produced by the transmitter is applied, by means of a suitable coupler, to a linear demodulator equipped with a de-emphasis network of 6 dB per octave.

The radio frequency signal shall be modulated successively at frequencies of 300, 500 and 1 000 Hz with a frequency deviation of +3,0 kHz. The audio input level shall be within the range given in paragraph 4.18.3 (or corresponding ranges when modulating frequencies are 300 or 500 Hz).

The harmonic distortion factor of the audio frequency signal is measured at all the frequencies given above.

4.15.3 Requirement

The harmonic distortion factor shall not exceed 5%.

4.16 RELATIVE AUDIO FREQUENCY INTERMODULATION PRODUCT LEVEL OF THE TRANSMITTER

4.16.1 Definition

The relative intermodulation product level is the ratio, expressed in decibels, of

- the level of an unwanted modulation component of the output signal caused by the presence of two modulating signals as a result of nonlinearity in the transmitter to
- the level of one of the wanted modulation signals measured at the output of the transmitter.

4.16.2 Method of measurement

a) Connect the equipment as shown in the following figure

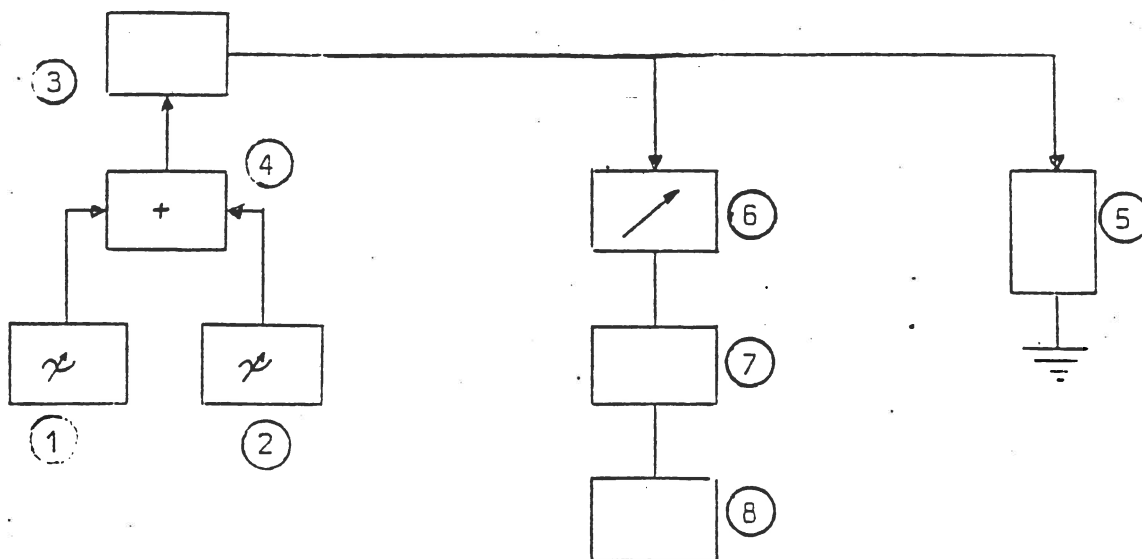

1. Audio frequency generator A
2. Audio frequency generator B
3. Transmitter under test
4. Audio frequency combining unit
5. Test load
6. Coupler/attenuator
7. Deviation meter
8. Audio frequency selective voltmeter.

b) In the absence of an output from audio frequency generator B, adjust the audio frequency generator A for produce +2,3 kHz frequency deviation at a modulating frequency  $F_2$  of 1600 Hz.

Record the output level of the audio frequency signal generator. The output level shall be within a range corresponding to the level range given in paragraph 4.18.3.

c) Reduce the output of generator A to zero and adjust the output of generator B to produce +2,3 kHz frequency deviation at a modulating frequency  $F_2$  of 1600 Hz.

d) Restore the output of generator A to the level recorded according b) and measure the relevant intermodulation products with the selective voltmeter.

The deviation meter shall be provided with a de-emphasis network of 6 dB per octave.

4.16.3 Presentation of results

Calculate the ratio, in decibels, of the levels of the intermodulation products measured in step (d), to the level of the wanted signal at 1000 Hz.

4.16.4 Requirement

The relative intermodulation product level shall not exceed -20 dB.

4.17 RESIDUAL MODULATION

4.17.1 Definition

The residual modulation of the transmitter is the ratio, expressed in dB, of the audio frequency noise level produced after radio frequency signal demodulation in the absence of modulation by the wanted signal, by the spurious effects of the power supply system, by the modulator or by other causes, to the audio frequency level produced by normal test modulation applied to the transmitter.

4.17.2 Method of measurement

- a) The normal test modulation, defined in paragraph 2.2.4, is applied to the transmitter. The RF signal produced by the transmitter is applied by means of a suitable coupler to a linear demodulator.

The demodulator is equipped with a de-emphasis network of 6 dB per octave.

All precautions shall be taken to prevent the measurement results from being affected by emphasis at the low audio frequencies of the internal linear demodulator noise.

Measurements shall be carried out on the demodulator output signal by means of an r.m.s. voltmeter equipped with psophometric filter network described in CCITT Recommendation P.53.A.

The modulation is then removed and the level of the residual audio frequency output signal is again measured.

- b) The same method as a) above but with the psophometric filter at the output.

In this case the measurements are carried out by means of a peak-to-peak voltmeter.

4.17.3 Requirement

For case a) the residual modulation shall not exceed -50 dB.

For case b) the residual modulation shall not exceed -30 dB.

4.18 SENSITIVITY OF MODULATOR, INCLUDING CONTROL UNIT (CU) AND MODEM

The transmitter line input terminal at the control unit (CU) shall be provided with a six-way socket link and test connector with double U-link plug according to IEC publication 130-12 IEC SO4/P03 to make it possible to break the line for maintenance measurements.

4.18.1 Definition

This characteristic expresses the ability of the transmitter to be sufficiently modulated when an audio frequency signal corresponding to the mean normal speech level is applied at the line terminal of CU.

4.18.2 Method of measurement

An audio frequency test signal of 1000 Hz is applied at the transmitter line input terminal. The level of the test signal is adjusted until  $\pm 3,0$  kHz deviation is obtained.

The audio frequency signal level under these conditions is the sensitivity of modulator.

4.18.3 Requirement

The sensitivity of modulator shall be settable in steps of 1 dB or less (or continuously) between -23 dBm and -3 dBm.

The nominal input level is -10 dBm.

## 4.19 INPUT IMPEDANCE

Input impedance measured at line input terminal in the frequency range 300-3400 Hz shall not deviate from  $600 \angle 0^\circ$  ohm by more than what corresponds to a reflection attenuation of 15 dB.

$$\text{Reflection attenuation} = 20 \log_{10} \left| \frac{Z_1 + Z_2}{Z_1 - Z_2} \right|$$

where  $Z_1$  = line input impedance

$$Z_2 = 600 \angle 0^\circ \text{ ohm}$$

## 4.20 IMPEDANCE SYMMETRY

The impedance unbalance attenuation measured at line input terminal shall not be less than:

46 dB in the frequency range 300 - 600 Hz

50 dB in the frequency range 600 - 3400 Hz.

The unbalance attenuation shall be measured as shown in the figure below.

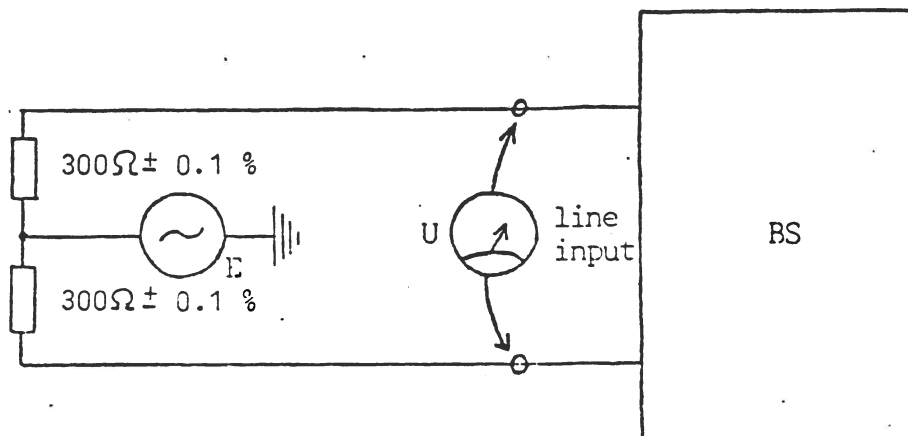

$$\text{Impedance unbalance attenuation} = 20 \log_{10} \frac{E}{U} \text{ dB.}$$

## 4.21 GROUP DELAY DISTORTION

### 4.21.1 Definition

Group delay distortion is the maximum difference between the shortest and the longest delay time within a specified modulation frequency range.

### 4.21.2 Method of measurement

An audio frequency test signal is applied at the line input terminal. The RF signal produced by the transmitter is applied by means of a suitable coupler to a linear demodulator.

All precautions shall be taken to prevent the measurement result from being affected by group delay distortion in the demodulator.

The frequency of the audio frequency test signal shall be varied while the frequency deviation is maintained constant  $\pm 1,0$  kHz and the delay time shall be measured.

The measurement may be carried out by means of a group delay measuring set according to CCITT Recommendation O.81.

### 4.21.3 Requirements

The group delay distortion shall not exceed:

200  $\mu$ s within the frequency range 600 - 3000 Hz but not

60  $\mu$ s within the frequency range 900 - 2100 Hz.

4.22 MODULATION DUE TO VIBRATION

4.22.1 Definition

Modulation due to vibration denotes the ability of the transmitter to withstand influence on the radio frequency output signal by mechanical vibrations.

4.22.2 Method of measurement

The radio frequency signal produced by the transmitter shall be applied, by means of a suitable coupler, to a deviation meter. A resistance equal to the normal input impedance of the transmitter shall be applied to the transmitter input. No modulation signal shall be applied to the transmitter.

In transmit condition, the transmitter shall then be vibrated in each of 3 directions:

15 - 4000 Hz	1 m/s <sup>2</sup>
sweep rate	1 octave per minute.

During the vibration the frequency deviation of the transmitter output signal shall be measured.

4.22.3 Requirement

The frequency deviation due to vibration shall not exceed ±0,3 kHz at any vibration frequency.



5 RECEIVER

For the purpose of simulating duplex operation, all requirements under section 5 shall be fulfilled with an unwanted signal of carrier frequency 10 MHz above the nominal frequency of the receiver and with the level 80 dB (1  $\mu$ V) E.M.F. measured at the receiver input. The unwanted signal shall be modulated with a 400 Hz tone to a frequency deviation of  $\pm 3,0$  kHz. A transmitter according to section 4 of this specification may be used as the unwanted signal source.

5.1 FREQUENCY RANGE

Receiver frequency range shall be 453,000-457,475 MHz. Channel separation shall be 25 kHz.

5.2 NUMBER OF RF-CHANNELS

The receiver shall be capable of being set to any of the 180 channels in the frequency range specified in clause 5.1.

The channel setting shall be possible in two different ways:

- locally, by means of channel selector on the control unit (CU)
- remotely from the MTX via the control unit (CU).

The channel setting order from MTX shall override the local channel setting.

5.3 RF-SENSITIVITY

5.3.1 Definition

The sensitivity of the receiver is the minimum level of signal (E.M.F.) at the input of the receiver which at the nominal frequency of the receiver and with normal test modulation (2.2.4) of the signal will produce the nominal audio frequency output level (paragraph 5.10.3) and a SND/ND ratio of 20 dB, measured at the line output terminal of the receiver through a psophometric filter.

Note 1. - The SND/ND ratio is the ratio of signal+noise+distortion to noise+distortion.

Note 2. - The frequency characteristics of the 1 kHz bandstop filter used in SND/ND measurement shall be such that at the output the attenuation at 1 kHz will be at least 40 dB and that at 2 kHz it shall not exceed 0,6 dB. The filter characteristic shall be flat within 0,6 dB over the ranges of 20 Hz to 500 Hz and 2 kHz to 4 kHz. In the absence of modulation, the filter shall not attenuate the total noise output power by more than 1 dB at the radio-frequency output of the receiver.

5.3.2 Method of measurement

A signal at the nominal frequency of the receiver and with normal test modulation, according to paragraph 2.2.4, shall be applied to the receiver input. An audio frequency output load and a distortion meter incorporating a 1 kHz band-stop filter and a psophometric telephone weighting network shall be connected to the receiver line output terminal. The test signal input level shall be reduced until a SND/ND ratio of 20 dB is obtained. Where possible, audio-frequency power control shall be adjusted to give the nominal output level at the line output terminal. If this is not possible, the input level is increased until the output power is adjustable to the nominal output level. The test signal input level under these condition is the sensitivity of the receiver.

Under extreme test conditions a variation of the receiver output power of +1 dB from the value obtained under normal test conditions may be allowed.

5.3.3 Requirements

The sensitivity shall not exceed -2 dB (1  $\mu$ V)E.M.F. under normal test conditions, and 0 dB (1  $\mu$ V)E.M.F. under extreme test conditions.

5.4 CO-CHANNEL REJECTION

5.4.1 Definition

The co-channel rejection is a measure of the capability of the receiver to receive a wanted modulated signal without exceeding a given degradation due to the presence of an unwanted modulated signal, both signals being at the nominal frequency of the receiver.

5.4.2 Method of measurement

Two input signals shall be applied to the receiver via a combining network. The wanted signal shall have normal test modulation. The unwanted signal shall have normal test frequency of 400 Hz to a frequency deviation of +3,0 kHz. Both input signals shall be at the nominal frequency of the receiver and the measurement shall be repeated for displacements of the unwanted signal up to +3,4 kHz.

Initially the unwanted signal shall be switched off and the level of the wanted signal shall be adjusted to +1 dB (1  $\mu$ V)E.M.F.. The unwanted signal shall then be switched on.

The level of the unwanted signal shall be adjusted until the SND/ND ratio, measured at the line output terminal of the receiver through the psophometric filter, is reduced to 20 dB.

The co-channel rejection is expressed as the ratio in dB of the level of the unwanted signal to the level of the wanted signal at the receiver input for which SND/ND = 20 dB at the receiver line output terminal occurs.

### 5.4.3 Requirements

The co-channel rejection ratio at any of the specified signal displacement shall not be less than -8 dB.

## 5.5 ADJACENT CHANNEL SELECTIVITY

### 5.5.1 Definition

The adjacent channel selectivity is a measure of the capability of the receiver to receive a wanted modulated signal without exceeding a given degradation due to the presence of an unwanted signal which differs in frequency from the wanted signal by an amount equal to the channel separation.

### 5.5.2 Method of measurement

Two signals shall be applied to the receiver via a combining network. The wanted signal shall be at the nominal frequency of the receiver and be modulated with normal test modulation. The unwanted signal shall be at the nominal frequency of the upper adjacent channel and be modulated with a 400 Hz tone to a frequency deviation of +3,0 kHz.

Initially the unwanted signal shall be switched off and the level of the wanted signal shall be adjusted to 1 dB (1  $\mu$ V)E.M.F.. The unwanted signal shall then be switched on and its level adjusted until the SND/ND ratio, measured at the receiver line output terminal through the psophometric filter, is reduced to 20 dB.

The measurement shall be repeated with the unwanted signal at the nominal frequency of the lower adjacent channel.

The adjacent channel selectivity shall be expressed as the lower value of the level in dB (1  $\mu$ V)E.M.F. of the unwanted signal for the upper and lower adjacent channels.

### 5.5.3 Requirement

The adjacent channel selectivity shall not be less than 75 dB (1  $\mu$ V)E.M.F. under normal and not less than 70 dB (1  $\mu$ V)E.M.F. under extreme test conditions.

## 5.6 SPURIOUS RESPONSE REJECTION

### 5.6.1 Definition

The spurious response rejection is a measure of the capability of the receiver to discriminate between the wanted modulated signal at the nominal frequency and unwanted modulated signal at any other frequency at which a response is obtained.

### 5.6.2 Method of measurement

Two input signals shall be applied to the receiver via a combining network. The wanted signal shall be at the nominal frequency of the receiver and be modulated with normal test modulation. Initially the unwanted signal shall be switched off and the wanted input signal adjusted to 1 dB (1  $\mu$ V)E.M.F.. The unwanted signal shall be switched on and modulated with a 400 Hz tone to a frequency deviation of +3,0 kHz. The input level of the unwanted signal shall be 96 dB (1  $\mu$ V)E.M.F. and its frequency shall be varied at least from 100 kHz to 2000 MHz.

At any frequency at which a response is obtained, the input level of the unwanted signal shall be adjusted until the SND/ND ratio, measured at the line output terminal of the receiver through the psophometric filter, is 20 dB.

The spurious response rejection shall be expressed as the level in dB (1  $\mu$ V)E.M.F. of the unwanted signal at the receiver input when the SND/ND ratio of 20 dB, as mentioned above, is obtained.

### 5.6.3 Requirement

The spurious response rejection shall not be less than 80 dB (1  $\mu$ V) E.M.F. for all frequencies except frequencies within the wanted channel and the adjacent channels.

## 5.7 INTERMODULATION REJECTION

### 5.7.1 Definition

The intermodulation rejection is a measure of the capability of the receiver to receive a wanted signal without exceeding a given degradation due to the presence of two unwanted highlevel signals.

### 5.7.2 Method of measurement

Three signals shall be applied to the receiver via a combining network. The wanted signal A shall be at the nominal frequency of the receiver and be modulated with normal test modulation. The unwanted signal B shall be tuned to a frequency 50 kHz above the frequency of the wanted signal and shall be unmodulated. The unwanted signal C shall be tuned to a frequency 100 kHz above the frequency of the wanted signal and be modulated with a 400 Hz tone to a frequency deviation of +3,0 kHz.

The level of the wanted signal A shall be adjusted to 1 dB (1  $\mu$ V) E.M.F.. The levels of the two unwanted signals B and C shall be maintained equal and increased in level until the SND/ND ratio, measured at the line output terminal of the receiver through the psophometric filter, is 20 dB.

The frequencies of signals B and C may be slightly adjusted to get maximum degradation of the SND/ND ratio and their levels adjusted again until the SND/ND ratio is again 20 dB.

The measurement shall be repeated with the two unwanted signals B and C tuned to 50 kHz and 100 kHz respectively below the frequency of the wanted signal.

The intermodulation rejection shall be expressed as the level in dB (1  $\mu$ V)E.M.F. of the unwanted signals at the receiver input when the SND/ND ratio of 20 dB, as mentioned above, is obtained.

5.7.3 Requirement

The intermodulation rejection shall not be less than 80 dB (1  $\mu$ V) E.M.F.

5.8 BLOCKING

5.8.1 Definition

Blocking is a change (generally a reduction) in the wanted output power of the receiver of a reduction of the SND/ND ratio due to an unwanted signal at another frequency.

5.8.2 Method of measurement

Two input signals shall be applied to the receiver via a combining network. The wanted signal shall be at the nominal frequency of the receiver and shall have normal test modulation. Initially the unwanted signal shall be switched off and the input level of the wanted signal shall be adjusted to 1 dB (1  $\mu$ V) E.M.F.

The output power of the wanted signal at the line output terminal of the receiver shall be adjusted to the nominal output level (paragraph 5.10.3). Then the unwanted signal shall be switched on. The unwanted signal shall be unmodulated, and its frequency shall be varied between +1 MHz and +10 MHz, and also between -1 MHz and -10 MHz, relative to the nominal frequency of the receiver. The input level of the unwanted signal, at all frequencies in the specified ranges, shall be adjusted so that the unwanted signal causes:

- a) a reduction of 3 dB in the audio frequency output power of the wanted signal, or
- b) a reduction of the SND/ND ratio to 20 dB, measured through a psophometric filter,

whichever occurs first.

This input level is the blocking level at the frequency concerned.

5.8.3 Requirement

The blocking level for any frequency within the specified ranges shall not be less than 100 dB (1  $\mu$ V)E.M.F. except at frequencies where spurious responses are found.

5.9 SPURIOUS EMISSIONS

5.9.1 Definition

Spurious emissions are any emissions from the receiver.

The level of spurious emissions shall be measured as:

- a) their conducted power in an artificial antenna and
- b) their effective radiated power when radiated by the cabinet and structure of the equipment (also called "cabinet radiation").

5.9.2 Method of measuring the conducted power

Conducted spurious emissions shall be measured as the power of any discrete signal at the input terminal of the receiver. The receiver input terminal is connected to a spectrum analyzer or selective voltmeter having an input impedance of 50 ohms, and the receiver is switched on.

If the measuring receiver is not calibrated in terms of absolute power, the power of any detected components shall be determined by a substitution method using a signal generator.

The measurement shall be carried out within at least the frequency range 100 kHz to 2000 MHz.

5.9.3 Method of measuring the effective radiated power

On a test site fulfilling the requirements of 2.2.8 the sample shall be placed at the specified height on a non-conducting support. The receiver shall be operated from a power source via a radio-frequency filter to avoid radiation from the power leads. The antenna terminal shall be connected to a 50 ohms resistive load.

Radiation of any spurious components shall be detected by the test antenna and measuring receiver over at least the frequency range from 30 MHz to 2000 MHz.

At each frequency at which a spectral component is detected, the sample shall be rotated to obtain maximum response and the effective radiated power of that component shall be determined by a substitution measurement.

The measurement shall be repeated with the test antenna in the orthogonal polarization plane.

5.9.4 Requirement

The power of any spurious emission in the measured range of frequencies shall not exceed 2,0 nW except within the frequency range from 453,0 MHz to 457,5 MHz where the conducted power shall not exceed 0,025 pW and the effective radiated power shall not exceed 10 pW.

## 5.10 AUDIO FREQUENCY POWER TO LINE

The receiver line output terminal at the control unit (CU) shall be provided with a six-way socket link and test connector with double U-link plug according to IEC publication 130 - 12 IEC SO4/PO3 to make it possible to break the line for maintenance measurements.

A separate output for the supervisory signal shall be available to feed the supervisory signal detector in the control unit. The supervisory signal output shall not be affected by squelch operation.

5.10.1 Definition

This characteristic expresses the ability of the receiver to deliver sufficient audio power to the line.

5.10.2 Method of measurement

A test signal at a level of 60 dB (1  $\mu$ V)E.M.F. at the nominal frequency of the receiver and having normal test modulation shall be applied to the receiver input.

The audio output power shall be measured at the line output terminal to a 600 ohms resistive load.

5.10.3 Requirement

The audio power at the line output terminal shall be settable in steps of 1 dB or less (or continuously) between -25 dBm and -5 dBm.

The nominal output level is -10 dBm.

## 5.11 LINE OUTPUT IMPEDANCE

The impedance measured at the line output terminal in the frequency range 300-3400 Hz shall not deviate from  $600/0^\circ$  ohms by more than what corresponds to a reflection attenuation of 15 dB.

$$\text{Reflection attenuation} = 20 \log_{10} \left| \frac{Z_1 + Z_2}{Z_1 - Z_2} \right| \text{ dB}$$

Where  $Z_1$  = line output impedance

$$Z_2 = 600/0^\circ \text{ ohms.}$$

## 5.12 IMPEDANCE SYMMETRY

The impedance unbalance attenuation to earth measured at the line output terminal shall not be less than:

- 46 dB in the frequency range 300 - 600 Hz
- 50 dB in the frequency range 600 - 3400 Hz.

The unbalance attenuation shall be measured as shown in the figure below.

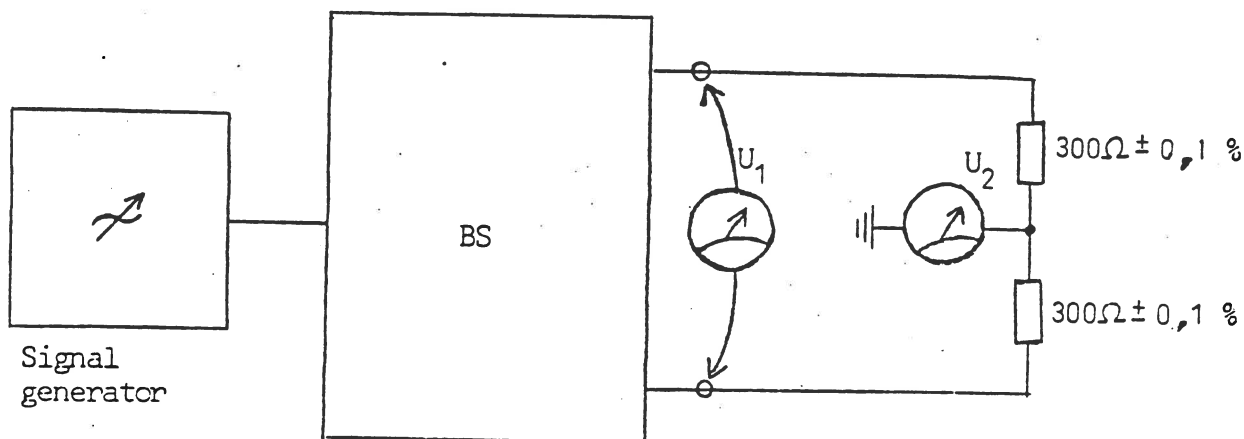

The impedance unbalance attenuation is  $20 \log_{10}(U_1/U_2)$  dB.

When performing the measurement, a test signal at a level of 60 dB (1  $\mu$ V)E.M.F. at the nominal frequency of the receiver and having normal test modulation shall be applied to the receiver input.

## 5.13 AMPLITUDE CHARACTERISTICS OF THE RECEIVER LIMITER

5.13.1 Definition

The amplitude characteristics of the receiver limiter is the relationship between the radio frequency input level of a specified modulated signal and the audio power at the receiver line output terminal.

5.13.2 Method of measurement

A test signal at a level of -2 dB (1  $\mu$ V)E.M.F. at the nominal frequency of the receiver and having normal test modulation shall be applied to the receiver input. The audio frequency power at the line output shall be adjusted to a level within the range given in paragraph 5.10.3. The input signal shall be increased to 100 dB (1  $\mu$ V)E.M.F., and the audio frequency output level shall again be measured.



### 5.13.3 Requirement

For the specified range of radio frequency input level, the change in the audio power at the line output terminal shall not exceed 2 dB between the minimum and maximum output power.

## 5.14 AM-SUPPRESSION

### 5.14.1 Definition

AM-suppression is the capability of the receiver to suppress amplitude modulated signals. It is expressed as the ratio in dB of the audio power at the line output terminal with normal test modulation to the audio power with a specified amplitude modulation.

### 5.14.2 Method of measurement

A test signal at a level of 20 dB (1  $\mu$ V) and 60 dB (1  $\mu$ V)E.M.F. at the nominal frequency of the receiver shall be applied to the receiver input successively. The signal shall initially have normal test modulation and the line output power shall be set to the nominal output level. The normal test modulation shall then be replaced by amplitude modulation to 30% with a 1000 Hz tone. The audio power shall again be measured. It may be necessary to make this measurement with a selective voltmeter.

### 5.14.3 Requirement

The AM-suppression shall not be less than 30 dB.

## 5.15 AUDIO FREQUENCY RESPONSE OF THE RECEIVER (INCLUDING LINE OUTPUT CIRCUIT)

### 5.15.1 Definition

The audio frequency response of the receiver expresses the variations in the audio power at the line output terminal as a function of the modulation frequency of the input signal.

### 5.15.2 Method of measurement

A test signal at a level of 60 dB (1  $\mu$ V)E.M.F. at the nominal frequency of the receiver and having normal test modulation shall be applied to the receiver input.

The audio power shall be adjusted to a level within the range given in paragraph 5.10.3. This setting shall not be altered during the test.

The frequency deviation at 1000 Hz shall then be reduced to  $\pm 1,0$  kHz and maintained constant while the modulation frequency is varied at least between 300 Hz and 5000 Hz.

The measurement is repeated with the test signal successively at plus and minus 2,5 kHz from the nominal frequency of the receiver.

5.15.3 Requirement

The audio frequency response shall be within the limits as shown in the figure below.

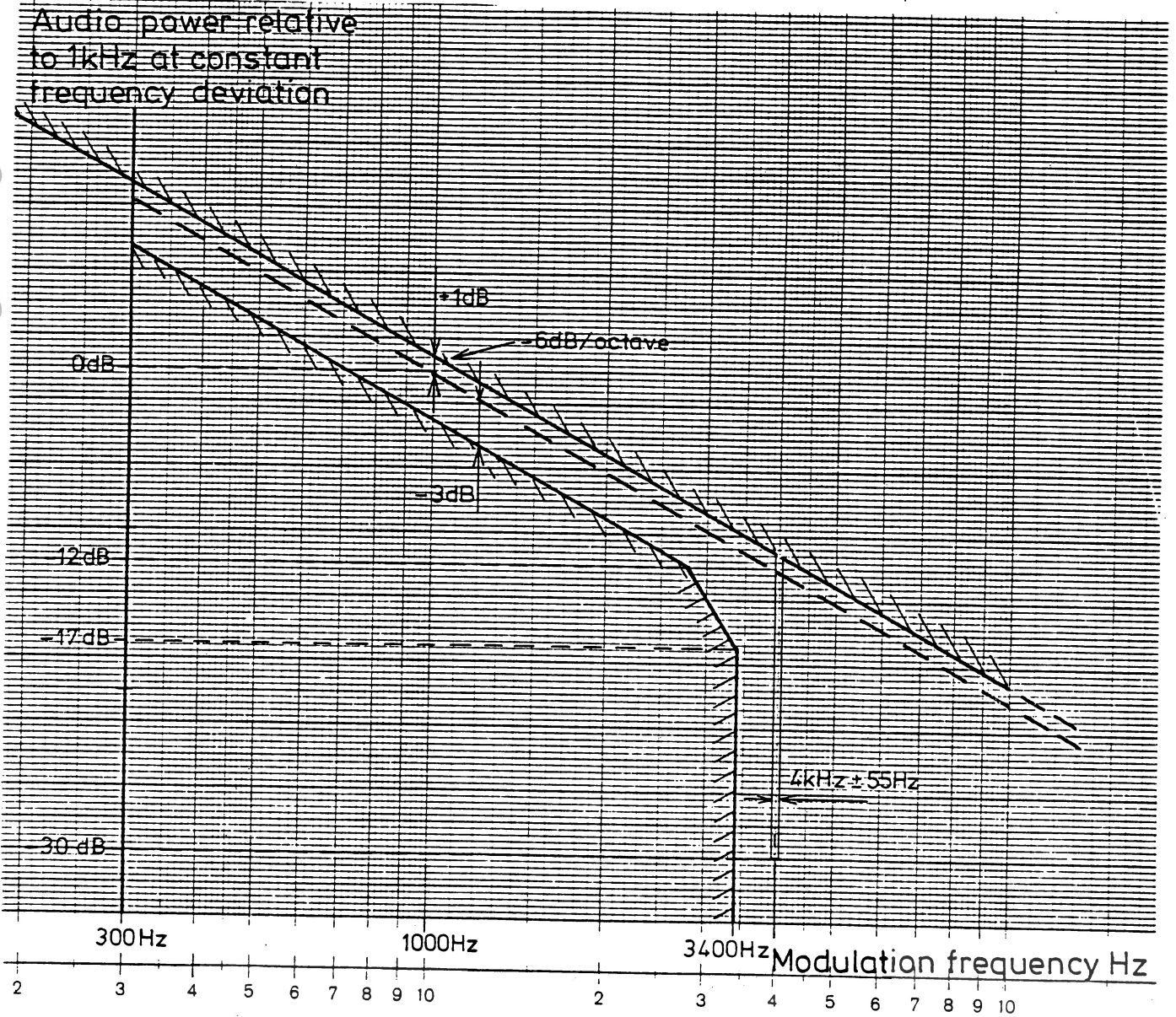

5.16 HARMONIC DISTORTION FACTOR

5.16.1 Definition

The harmonic distortion factor at the line output of the receiver is defined as the ratio, expressed as a percentage, of the r.m.s. voltage of all the harmonic components of the fundamental audio frequency to the total r.m.s. line output voltage.

With the method of measurement described on the next page, in case a distortion meter is used, the hum and noise components are included in the distortion measurement.

5.16.2 Method of measurement

Test signals of 60 dB (1  $\mu$ V)E.M.F. and 100 dB (1  $\mu$ V)E.M.F. at the nominal frequency of the receiver shall be applied successively to the receiver input.

In each measurement the audio power at the line output terminal shall be adjusted to deliver a level within the range given in paragraph 5.10.3 (or corresponding ranges when modulating frequencies are 300 or 500 Hz) to a resistive 600 ohms load.

The test signal shall be modulated successively with 300, 500 and 1000 Hz tones to  $\pm 3,0$  kHz frequency deviation and the harmonic distortion is measured at each frequency.

Under extreme test conditions, tests shall be carried out at the nominal frequency of the receiver as well as at plus and minus 2,5 kHz from the nominal frequency. In this case the input signal is modulated only with a 1000 Hz tone to a frequency deviation of  $\pm 3,0$  kHz.

5.16.3 Requirement

At all audio frequencies used in the measurement and under all test conditions the harmonic distortion factor shall not exceed 5%.

5.17 RELATIVE AUDIO FREQUENCY INTERMODULATION PRODUCT LEVEL OF THE RECEIVER

5.17.1 Definition

The relative intermodulation product level is the ratio, expressed in decibels, of the level of an unwanted component of the output signal caused by the presence of two unmodulating signals as a result of nonlinearity in the receiver to the level of the greater of the wanted output signals measured at the line output terminal.

5.17.2 Method of measurement

a) Connect the equipment as shown in the figure below.

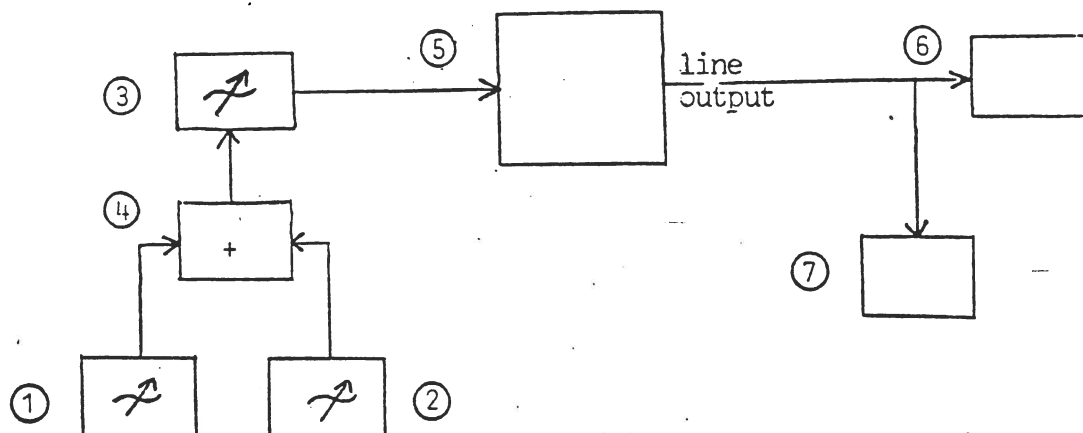

1. Audio-frequency generator A
2. Audio-frequency generator B
3. Radio-frequency signal generator
4. Audio-frequency combining unit
5. Receiver under test
6. Audio-frequency test load
7. Audio-frequency selective voltmeter.

- b) Adjust the radio-frequency test signal to the nominal frequency of the receiver and the test signal level successively to 20 dB, 60 dB (1  $\mu$ V)E.M.F.
- c) In the absence of an output from audio-frequency generator B, adjust the audio-frequency generator A to produce a  $\pm 2,5$  kHz frequency deviation at a modulation frequency of 1000 Hz. Adjust the audio power at the line output terminal to a level within a range corresponding to the level range given in paragraph 5.10.3. Record the output level of the generator A.
- d) Reduce the output of generator A to zero and adjust the output of generator B to produce a  $\pm 2,5$  kHz frequency deviation at a modulation frequency of 1600 Hz.
- e) Restore the output of generator A to the level recorded to c) and measure the level of the 1000 Hz component and of the intermodulation products at the line output terminal.

5.17.3 Requirement

The relative audio frequency intermodulation product level shall not exceed -20 dB.

## 5.18 NOISE AND HUM OF THE RECEIVER

### 5.18.1 Definition

The "noise and hum" of the receiver is the ratio, expressed in decibels, of the audio frequency noise and hum level resulting from the spurious effects of the power supply system or from other causes, to the audio frequency level produced by RF-signals as specified below and applied to the receiver input.

### 5.18.2 Method of measurement

- a) A test signal at a level of 30 dB (1  $\mu$ V)E.M.F. at the nominal frequency of the receiver and having normal test modulation shall be applied to the receiver input. A 600 ohms resistive load and a psophometric filter shall be connected at the line output terminal. The audio power at the line output terminal shall be adjusted to a level within the range given in paragraph 5.10.3.

The output voltage is measured with an r.m.s. voltmeter.

The modulation is then removed and the audio power measurement is repeated.

- b) The same method as in case a) above, but without the psophometric filter and using a peak-to-peak voltmeter for the measurement.
- c) The measurement according to a) above shall be repeated at a level of A dB (1  $\mu$ V)E.M.F.

### 5.18.3 Requirement

In case a) the receiver "noise and hum" ratio shall not exceed -50 dB.

In case b) the receiver "noise and hum" ratio shall not exceed -30 dB.

In case c) the receiver "noise and hum" ratio shall not exceed -BB dB.

## 5.19 GROUP DELAY DISTORTION

### 5.19.1 Definition

Group delay distortion is the maximum difference between the shortest and the longest delay time within a specified modulation frequency range.

### 5.19.2 Method of measurement

A test signal at a level of 60 dB (1  $\mu$ V)E.M.F. at the nominal frequency of the receiver shall be applied to the receiver. The signal shall be modulated by an audio frequency test signal.

All precautions shall be taken to prevent the measurement from being affected by the group delay distortion in the signal generator.

The frequency of the audio frequency test signal shall be varied while the frequency deviation is maintained constant at  $\pm 3,0$  kHz and the delay time is measured at the line output terminal.

The measurement may be carried out by means of a group delay measuring set according to CCITT Recommendation O.81.

### 5.19.3 Requirement

The group delay distortion shall not exceed:

200  $\mu$ s within the frequency range 600 - 3000 Hz but not  
60  $\mu$ s within the frequency range 900 - 2100 Hz.

## 5.20 SQUELCH

### 5.20.1 Squelch opening and closing levels

The squelch opening level measured with an RF test signal with normal test modulation shall be -2 dB (1  $\mu$ V)E.M.F.  $\pm 1$  dB at normal test conditions.

The squelch opening level shall be adjustable from the front of the receiver cabinet. The adjustment range for squelch opening level shall be at least -2 dB to +6 dB relative to the above mentioned opening level setting.

The squelch closing level shall be 1 to 2 dB below the opening level.

At extreme test conditions the opening and closing level shall not differ by more than 2 dB from the levels at normal test conditions.

The squelch opening and closing levels shall not vary by more than  $\pm 2$  dB from the levels obtained with an unmodulated test signal under conditions of receiving a test signal having  $\pm 3$  kHz deviation and with a carrier offset of  $\pm 2,5$  kHz. The modulation frequency shall be varied between 300-3400 Hz. The supervisory signal shall be included during the measurement.

It shall be possible to switch the squelch on and off locally from the control unit.

## 5.20.2 Squelch opening and closing delays

### 5.20.2.1 Definition

The squelch opening and closing delays are the intervals between the time of occurrence of a specified increase or decrease of a modulated radiofrequency input-signal level and the time when the voltage at the line output is 50% of its steady-state unsquelched value.

### 5.20.2.2 Squelch control by data signal

Single frame data signalling from MTX shall switch the squelch function in and out. Frame 20 A (3) and frame 20 A (11) shall switch the squelch function out. Frame 20 A (0) and frame 20 A (12) shall switch the squelch function in.

### 5.20.2.3 Method of measurement

An oscilloscope shall be connected to the line output terminal connected to a 600 ohms resistive load, and an electrically-operated, single-step attenuator having at least a 30 dB difference in attenuation shall be connected between the radio-frequency signal generator and the receiver.

The operating time of an attenuator shall be short compared with the expected squelch opening and closing times.

The signal generator shall be modulated with normal test modulation.

With the 30 dB step attenuator at the low attenuation value, the test signal shall be adjusted to the nominal frequency of the receiver and to a level of 1 dB above the actual squelch opening level. The measurement shall be repeated at a higher RF-level.

The synchronizing pulse for the calibrated horizontal sweep of the oscilloscope shall be derived from the attenuator activating signal.

The state of the step attenuator shall then be changed from low to high attenuation and after that back to low attenuation again. Record the squelch opening and closing delays  $t_o$  and  $t_c$  respectively as the interval between the attenuator activating signal and the time at which the voltage at the line output terminal has reached 50% of its steady-state unsquelched value (see figure below).

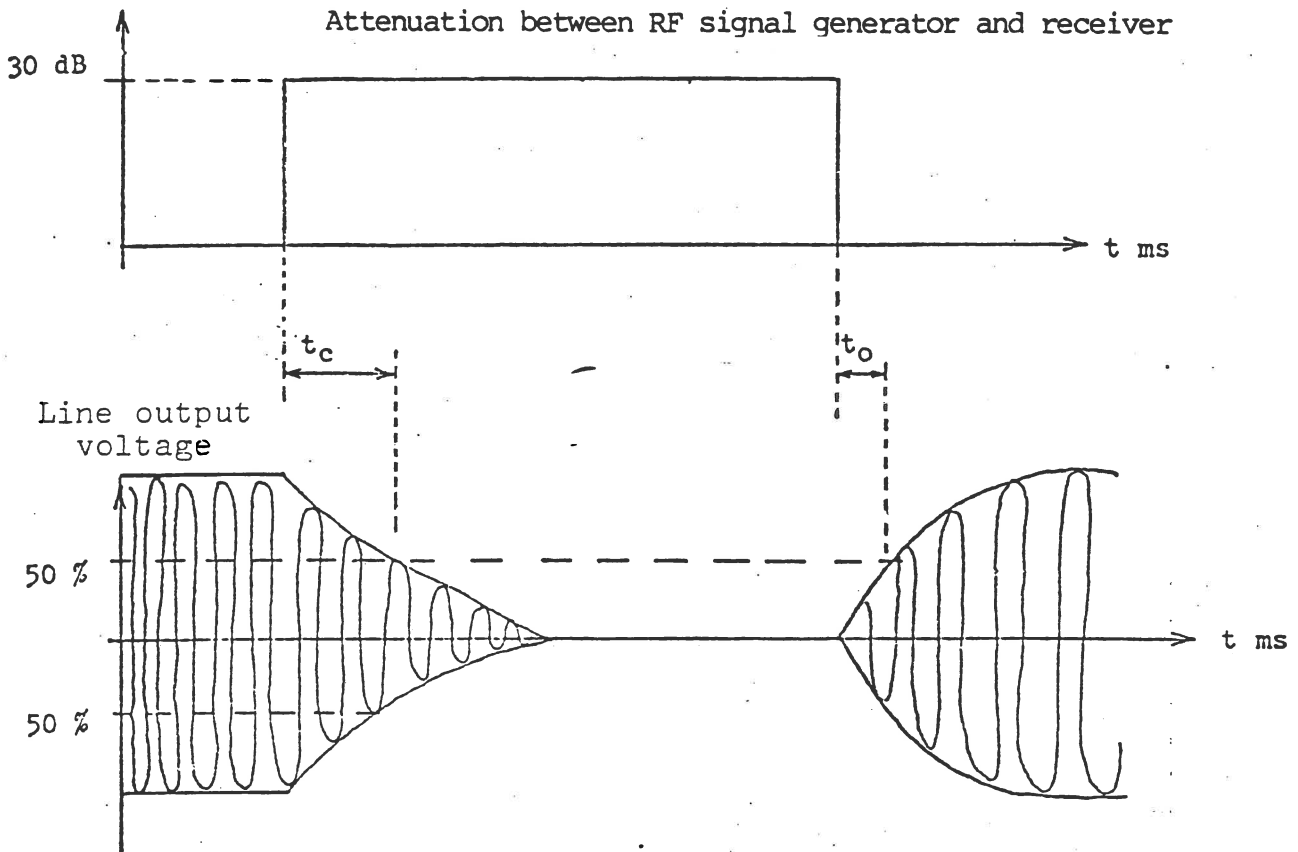

5.20.2.4 Requirement

Opening and closing delays shall be:

$$\text{Opening delay } t_0 = 5 \begin{matrix} +1 \\ -4 \end{matrix} \text{ ms}$$

$$\text{Closing delay } t_c = 150 \pm 30 \text{ ms.}$$

5.21 AUDIO OUTPUT DUE TO VIBRATION

5.21.1 Definition

Audio output due to vibration denotes the ability of the receiver to withstand influence on a received radio frequency signal by mechanical vibrations.

5.21.2 Method of measurement

A test signal at a level of 30 dB (1 μV) E.M.F. at the nominal frequency of the receiver having normal test modulation shall be applied to the receiver input. A 600 ohms resistive load shall be connected to the line output terminal. The audio power shall be adjusted to a level within the range given in paragraph 5.10.3.

The level of the output signal shall be measured by an r.m.s. voltmeter and the measured level shall be recorded.



The receiver shall then be vibrated in each of 3 directions.

15 - 4000 Hz	1 m/s <sup>2</sup>
sweep rate	1 octave per minute

During the vibration the radio frequency test signal shall be unmodulated and the level of the receiver output signal shall be measured.

5.21.3 Requirement

The audio power at any vibration frequency shall not exceed -20 dB relative to the audio power at normal test modulation without vibration.

6

SIGNALLING BETWEEN MTX AND BASE STATION

The signalling between MTX and BS can be divided into two different types:

- individual remote control of each radio channel such as start and stop of transmitter, channel setting, start and stop of supervisory signal and fault alarm via channel line and CU.
- remote control of signal strength measurements as controlled by SU.

The signalling between MTX and SU shall be possible both via a separate data line and via any of the channel lines through the CU. Data signal levels at BS are specified in NMT Doc.1, clause 4.6. The specified levels correspond to the normal data test modulation, see paragraph 2.2.4.2 in this document.

The requirement for the bit error rate of the demodulator in the BS modem shall be according to fig. 4.6.7 in NMT Doc.1 with the values for S/N ratio increased by 3 dB. The requirements shall also be fulfilled at a group delay distortion according to the figure below.

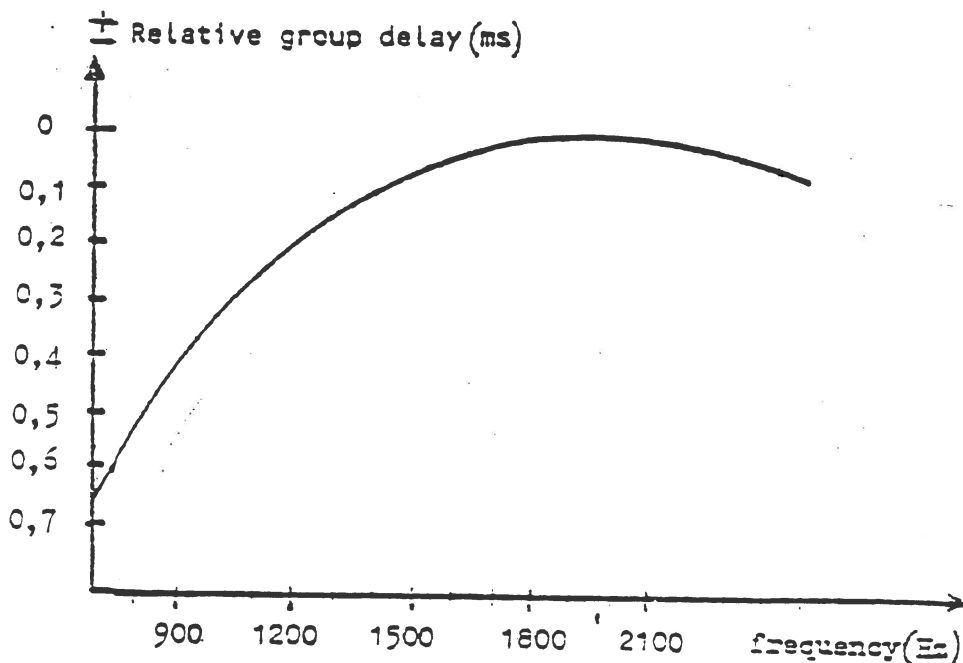

For further information about the signalling system refer to NMT Doc.1.

7 SIGNAL STRENGTH RECEIVER (SR)

## 7.1 GENERAL

The base station is equipped with an all-channel signal strength measuring receiver which is controlled from the MIX via the supervisory unit (SU) at the base station. The SU receives the measuring command (frame 21b or 21c) and switches the SR to channel  $N_a N_b N_c$  ordered by MIX.

Besides the requirements in this section 7, the Signal strength receiver (SR) shall fulfil the requirements in section 5 "Receiver".

## 7.2 SPECIAL REQUIREMENTS

7.2.1 Channel setting

The channel setting of the SR shall be remotely controlled from the SU.

7.2.2 Channel switching time

The switching time between arbitrary channels shall not exceed 40 ms (see clause 9.1.1) as defined in the figure below.

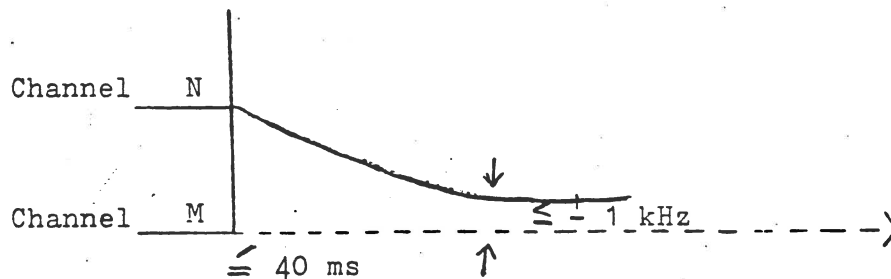

Note: M and N may be any of the base station receive frequencies.

7.2.3 Signal strength measurement output

The signal strength measurement output ( $R_{out}$ ) as a function of the RF input signal level  $U_{RF}$  shall have an analog logarithmic characteristic as below:

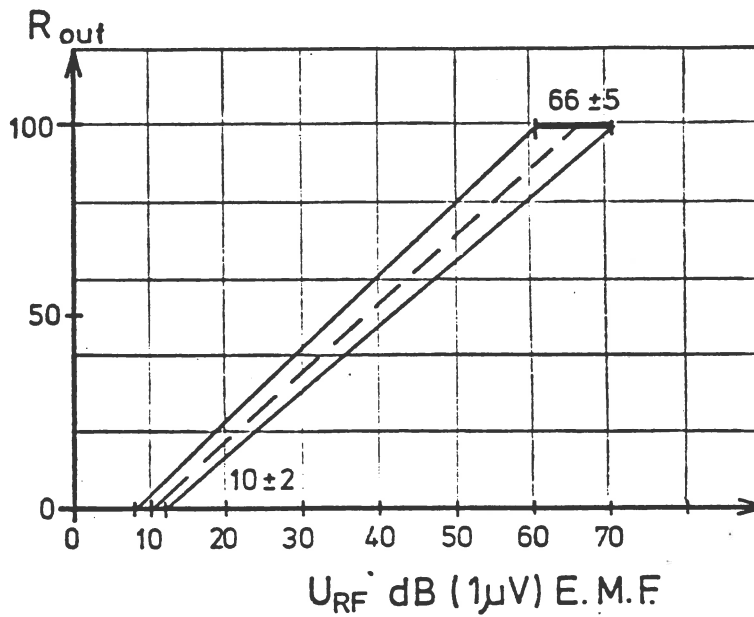

All the values below  $10 \pm 2$  dB (1  $\mu$ V)E.M.F. shall be sent as 0% and all the values above  $66 \pm 5$  dB (1  $\mu$ V)E.M.F. shall be sent as 100% to the MTX.

At RF-signal levels below squelch opening level according to clause 5.20 (at squelch closed condition).

$$R_{out} = 0$$

The integration time of the signal strength output shall not exceed 1 ms.

8 CONTROL UNIT (CU)

8.1 BASIC FUNCTIONS

The control unit shall provide functions for the actual channel, and be interface between MTX and channel equipment. The CU shall also be able to transfer data information between SU/SR and MTX. Data signalling from SU/SR to MTX (frames 26 and 28) shall be transferred by that CU which is latest used by MTX for the signal strength measurement order.

In the signalling from CU to MTX the channel number  $N_1N_2N_3$  shall be in accordance to the channel number used by MTX in frame 20 A(15) start transmitter. The first three bits in  $N_1$  and  $N_a$  shall have the value 011 in the signalling towards MTX. If the channel number register is empty (e.g. after power start up) the channel number  $N_1=N_2=N_3=14$  or the number copied from the local channel number switch shall be used.

If an acknowledgement to an order from MTX is specified, it shall have been sent within 200 ms measured from the end of the order frame.

At signalling from CU to MTX the radio receiver speech output shall be muted. The signalling from MTX to CU is allowed to pass to the mobile stations.

8.1.1 Channel activation ordered by MTX

The CU shall activate the channel equipment as ordered by MTX in frame 20 and send the acknowledgement (frame 25) according to NMT Doc.1, clause 4.3.3.6.

The acknowledgement shall be response on the received order regardless of the actual state of the BS.

8.1.2 Management/maintenance ordered by MTX

The CU shall activate the BS equipment as ordered by MTX in frame 22. See NMT Doc.1, clauses 4.3.3.7 and 4.3.3.8.

8.1.3 Fault alarms via CU

The coding and meaning of the alarms are specified in NMT Doc.1, clause 4.3.3.9.

One frame 15 (idle) shall be sent before frame 28 (alarm) for synchronization purposes. There shall be no space between the frames.

When sending frame 28 containing blocking (V1(6)) the BS shall idle the channel. This corresponds to reception of frame 20 A (0).

### 8.1.3.1 NMT alarms

When a fault occurs, the CU shall send fault alarm once to MTX (one frame 28) at:

- Antenna fault, inter alia the VSWR at the TX-combiner output or transmitter output, exceeds a preset level. There shall be two levels and they shall be adjustable within the VSWR range (1,2 - 2,0). The alarm interface between CU and transmitter combiner is specified in paragraph 3.1.14.

Note 1: See clause 3.1.13 "Test features".

Note 2: Fault alarm shall be sent on all channels which are connected to this transmitter combiner.

- Transmitter fault level 1, when the carrier output power is below a preset level 1. The level 1 shall be adjustable within the range (-15 dB, -3 dB) relative to nominal output power.
- Transmitter fault level 2, inter alia when:
  - the carrier output is below a preset level 2. The level 2 shall be adjustable within the range (-15 dB, -3 dB) relative to normal output power.
  - the synthesized frequency is unlocked (not during channel switching time and power start-up period).
  - any of the DC-voltages is below a preset level.
- Receiver fault, inter alia when:
  - the synthesized frequency is unlocked (not during channel switching and power start-up period)
  - any of the DC-voltages is below a preset level.
- Receiver multicoupler fault, inter alia when power-failure or amplifier failure occurs.

Note 1 See clause 3.2.14.

Note 2 Fault alarm shall be sent on all channels which are connected to this receiver multicoupler.

- Power supply fault, inter alia when the voltage is below a preset level.

Note 1 The fault alarm shall be sent on all channels which are connected to this power supply.

Note 2 Power supply fault shall not cause any other alarms.

- CU fault, if possible.

Note See clause 8.1.6.

- Supervisory signal test loop fault alarm according to paragraph 8.1.5.3.
- SU/SR faults, see chapter 9.

### 8.1.3.2 House alarms

In addition to alarms above shall following alarms be sent to MTX:

- Mains break-down alarm;
- Mains break-down at channel with battery back-up;
- Mains return alarm,
- Fire alarm;
- Intruder alarm;
- Obstruction light alarm.

It shall be possible to take in use at least two spare house alarms which are coded as  $V_1(10)V_2(1)V_3(6)$  and  $V_1(10)V_2(1)V_3(7)$ .

The interface for house alarms shall be the same as for transmitter combiner by means of relay contacts (alarm = relay closed). The relay contacts are mostly not connected to ground. The mains break-down alarm relay contact will be closed within 30 ms from the mains break-down.

The alarms concerning mains break-down at the base station shall be sent to MTX on all the lines which are influenced of the fault. The information in frame 28 includes order to MTX to block the channel,  $V_1(6)V_2(1)V_3(1)$ . That is, at base station, without battery back-up this alarm shall be sent on all the lines.

At some base station sites it may be used battery back-up for some of the channels and SU/SR. In the case "mains break-down alarm on channel with battery back-up" ( $V_1(10)V_2(1)V_3(5)$ ) shall be sent on the corresponding lines.

As an alternative at the base station channels with battery back-up, the following meanings of the alarms may be used:

- Mains break-down alarm: the battery voltage is below 48 V
- Mains return alarm: the battery voltage has returned above 48 V.

At mains interruptions the BS shall automatically restart when the mains return (see also clause 1.3.13.7). If the BS has sent a blocking alarm the mains return alarm shall be sent when the mains return. The same shall happen when the power is switched on.

The mains break-down shall not cause any other alarm but the one indicating the original failure.

### 8.1.3.3 External alarms

It shall be possible to take in use at least four spare external alarms which are coded as  $V_1(10)V_2(8)V_3(X)$ , where  $X = 8 \dots 11$ .

The interface for external alarms shall be the same as for transmitter combiner by means of relay contacts (alarm = relay closed). The relay contacts are mostly not connected to ground.

#### 8.1.3.4 Alarm indication

At least NMT alarms sent to MTX shall be indicated at the base station. The indication should point out the faulty units.

All the alarm indicators shall be red. Two level alarms may be indicated by a single indicator, if level one alarm is flashing and level two alarm is continuous.

All the alarm indications shall be reset by order from MTX (frame 22) or by local control. If the fault(s) remains, the CU shall repeat the alarm(s) (on frame 28) to the MTX. This makes it possible to see if an alarm state has been changed.

#### 8.1.4 Channel setting, remotely controlled from MTX

The CU shall set the frequency in accordance to the digits  $N_1N_2N_3$  in frame 20 A(15) "Start BS transmitter". If  $N_1N_2N_3$  falls outside the NMT band (channels 1-180), the transmitter shall not be started. In this case, the order shall not be acknowledged.

#### 8.1.5 Supervisory signal ( $\emptyset$ -signal)

##### 8.1.5.1 Generation

The CU shall generate the supervisory signal as ordered from the MTX (Frame 20 A(3) Start, A(12) Stop). The frequencies ( $f_{\emptyset}$ ) used for the supervisory signal are given below. The frequency setting of the supervisory signal shall be remotely controlled from MTX (frame 20) or by local setting.

Frequency 1	$3955 \pm 10$ Hz
2	$3985 \pm 10$ Hz
3	$4015 \pm 10$ Hz
4	$4045 \pm 10$ Hz.

The frequency deviation shall be  $\pm(0,3 \pm 0,03)$  kHz.

The time between the end of send supervisory signal order and the setting of the  $\emptyset$ -signal shall be max. 50 ms. In the case of a change in the  $\emptyset$ -signal frequency a response of max. 100 ms is accepted.

##### 8.1.5.2 Detection

The CU shall detect the supervisory signal, looped in the mobile station and shall evaluate its signal-to-noise ratio and compare it with limits which correspond to signal-to-noise ratios S/N, psophometrically measured at normal test modulation in speech channel given below.



Limit S/N ratio in speech channel (psophometric)

- 1 30 dB (adjustable between 10 and 40 dB)
- 2 -5 dB (adjustable between -10 and 0 dB.)

Note 1 When testing the limit setting, the speech channel shall be unmodulated.

After evaluation stated below, one of the following messages shall be sent to MTX:

S/N ratio in speech channel	Message to MTX (one frame only)
Above 1st limit for more than 3 s during the last 10 s.	No message shall be sent
Below 1st limit for more than 7 s during the last 10 s but above 2nd limit for more than 1 s period during the last 20 s.	Received $\emptyset$ -signal below 1st limit but above 2nd limit. Frame 25 A(7).
Not above 2nd limit for more than 1 s during the last 20 s.	Received $\emptyset$ -signal below 2nd limit. Frame 25 A(8)

Note 2 Message shall be sent to MTX when an alarm limit is passed and repeated after 20 s periods as long as the evaluated value does not pass an alarm limit again.

If no supervisory signal on the transmitted  $\emptyset$ -signal frequency (S/N ratio in speech channel below limit 2) is received within 3 s after reception of the command "send  $\emptyset$ -signal" from MTX, frame 25 A(8) shall be sent to MTX.

The supervisory detector shall measure the S/N of the looped  $\emptyset$ -signal. The  $\emptyset$ -signal shall be measured within the frequency range  $f_{\emptyset} \pm 10$  Hz (3 dB bandwidth), and the noise at least within the frequency range  $f_{\emptyset} \pm 100$  Hz but not outside the frequency range 3800 to 4200 Hz (35 dB bandwidth).

#### 8.1.5.3 $\emptyset$ -signal test loop

The  $\emptyset$ -signal test loop is intended for testing the  $\emptyset$ -signal generator and detector. At the test the generator output shall be connected to the detector input. If an unnormal  $\emptyset$ -signal level or S/N ratio is measured, supervisory signal failure alarm (frame 28) shall be sent to MTX. When the supervisory signal is not activated, the  $\emptyset$ -signal test loop shall be connected.

#### 8.1.6 Channel line loop

The CU shall loop the transmitter line input to the corresponding receiver line output as ordered from the MTX (frame 20 A(5)) and at faults in the CU. The attenuation in the loop connection shall not

exceed 0,5 dB. The loop shall also be connected when the power is not applied to CU (with modem) but not before a possible alarm frame has been sent.

The attenuation in the loop connection shall not exceed 0,5 dB.

The group delay distortion in the loop connection shall not exceed 40 µs within the frequency range 900 - 2100 Hz.

The channel line loop shall be connected/disconnected within 100 ms after received order.

8.1.7 Local control

The CU shall provide local controls as

- start and stop of transmitter;
- channel setting of transmitter and receiver;
- squelch on/off of receiver;
- activating RF test loop;
- activating Ø-signal and selection of Ø-signal frequency;
- resetting alarms;
- sending blocking/deblocking order to MTX (frame 28). Locally blocked channel shall be indicated.

Some of the local controls may be placed on other base station units.

The indicator colours on BS unit panels shall be as follows:

Alarms	red
Tx-carrier	green
Squelch open	green
Power on	yellow
Local blocking sent to MTX	red
RF-test-loop on	red

The signalling from the MTX shall override the local control.

8.1.8 Line test connectors

The CU-panel or modem panel shall be provided with a line test socket/connector according to IEC Publication 130-12IEC-S04/PO3 (see paragraph 5.10).

8.1.9 Service functions

Measurements with built-in instruments shall be possible for active circuits and supply voltages. In addition to important functional values the built-in instruments shall show e.g.

- transmitter output power;
- reflected power from the antenna/combiner;
- received RF-level;

- receiver discriminator;
- line input and output levels. The instrument shall indicate the average value in all voltage level measurements.

The measuring accuracy shall be better than +5%.

The instruments may be common for several transmitters and receiver units. It shall be possible to measure the  $\emptyset$ -signal frequency and level via terminals on one of the panels. The base station shall be equipped with handset and terminals for audio control. The handset shall be equipped with a push-to-talk switch.

### 8.1.10 Control unit flow chart

Example of handling the channel activation order (frame 20)

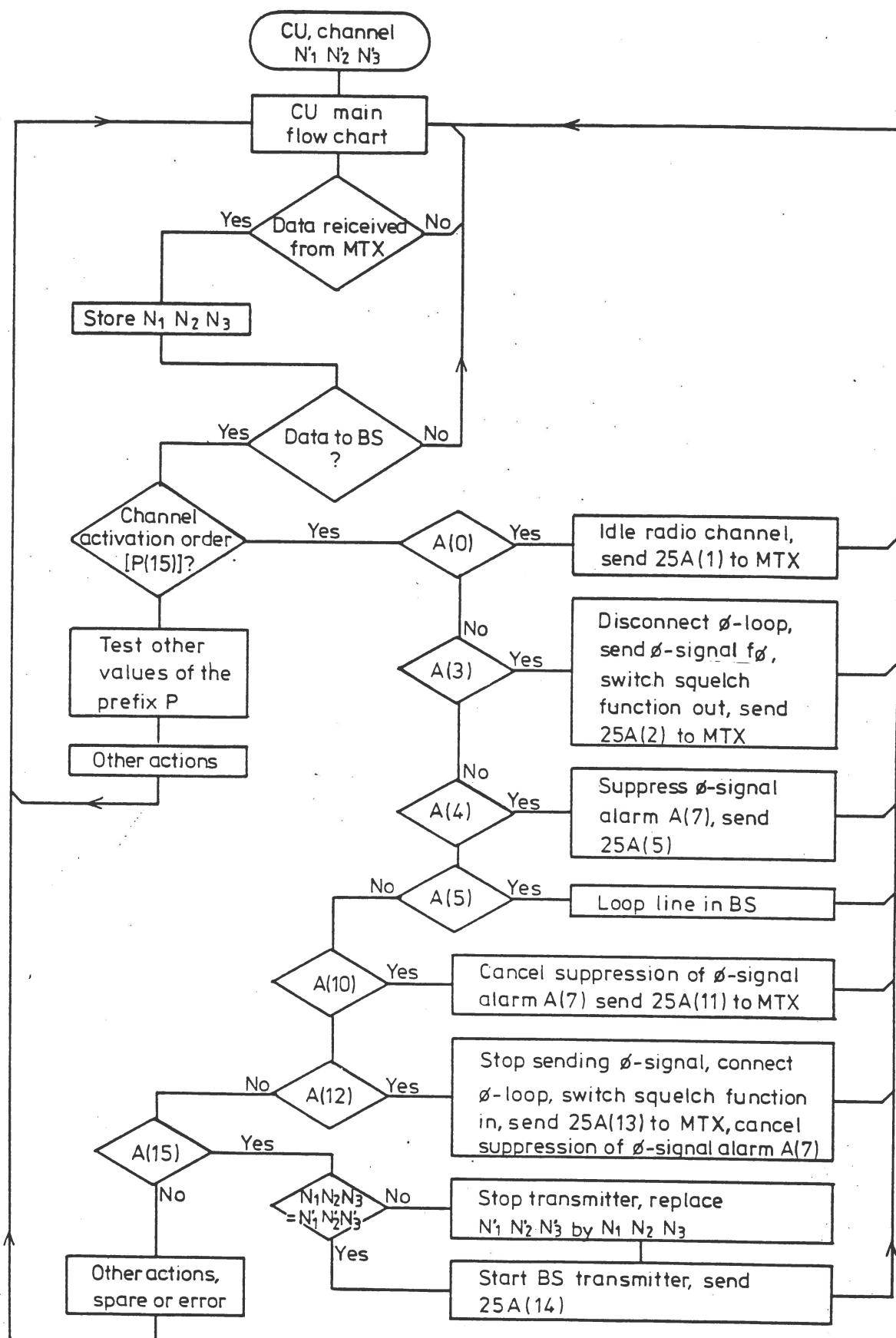

9 SUPERVISORY UNIT (SU)

9.1 BASIC FUNCTIONS

The SU provides function for signal strength measurements and interface between the signal strength receiver on the one side and MTX or CU on the other side. The SU shall not be used for communication between MTX and MS.

9.1.1 Signal strength measurements

SU receives the measuring order from MTX via channel line and CU or via data line and switches the SR to the ordered channel  $N_a N_b N_c$  (frame 21b or 21c) according to section 7.

The average signal strength shall be measured for a time period of  $100 + 20/-5$  ms and shall be quantified in 64 levels. At 100% of  $R_{out}$  the coding shall be 0011 1111 ( $R_1(3)R_2(15)$ ) and at 0% of  $R_{out}$  0000 0000 ( $R_1(0)R_2(0)$ ). The quantified binary value for the RF-signal level shall be sent to MTX. The tolerance of the A/D converter shall not exceed  $\pm 1\%$  FS (full scale)  $\pm 1/2$  LSB (least significant bit).

The total time for SR channel switching and evaluation of the average signal strength value shall not exceed 138 ms (one frame).

The signal strength measurement result (frame 26) shall have been sent from base station equipment to MTX within 415 ms (3 frames) measured from the end of received signal strength measurement order (frame 21b or 21c) at the base station.

Measurement orders may be given in a continuous string of frames 21b or 21c. In that case also the measurement results shall be sent to the MTX as a continuous string of frames 26. There shall be no space between the frames and the results must be sent in the same order as the corresponding measurement orders have come.

Signal strength measurement results shall be sent to MTX via the same line which was latest used by MTX for signal strength measurement order.

9.1.2 Fault alarm via SU

When a fault occurs, the SU shall send a fault alarm once to MTX (one frame 28) at:

- SU fault, if possible;

Note: see clause 9.1.4, Data line loop.

- signal strength receiver fault, inter alia when:

--the synthesized frequency is unlocked (not during channel switching time and power start-up-period);

--any of the DC-voltages is below a preset level.

At least fault alarms listed above and sent to MTX shall be indicated at the base station. The indication should point out the faulty units.

One frame 15 (idle) shall be sent before frame 28 (alarm) for synchronization purposes. There shall be no space between the frames.

In case there is no separate data line, the SR and SU alarm shall be sent via that CU through which the measuring orders are received.

If the fault alarm is sent via CU on channel line, blocking order V<sub>1</sub>(6) shall be replaced by V<sub>1</sub>(12).

9.1.3 (Deleted)

9.1.4 Data line loop

At faults in SU (including the data line modem) the data line input shall be connected to the data line output. The loop shall also be connected when the power is not applied to SU (with modem) but not before a possible alarm frame has been sent. On the other hand the loop shall be connected/disconnected within 100 ms after received order (frame 20A(5)/20A(0)).

The attenuation in the loop connection shall not exceed 0,5 dB.

The group delay distortion in the loop connection shall not exceed 40  $\mu$ s within the frequency range 900 - 2100 Hz. If there is an indication of the "loop-on" condition, it shall be red.

Data line test connector

9.1.5

The SU-panel or modem panel shall be provided with a line test socket/connector according the IEC Publication 130 - 12 IEC - S04/PO3 (see paragraph 8.1.8)

10

RF TEST LOOP

The RF test loop is intended for testing each individual channel equipment one at a time.

The RF test loop consists inter alia of an oscillator with a frequency of 10 MHz and a mixer by means of which the transmitter frequency can be converted to the corresponding receiver frequency.

The attenuation in the RF test loop shall be such as to give a level of 8 dB(1  $\mu$ V)EMF at the receiver input. The level shall be adjustable within the range 3 dB(1  $\mu$ V) to 13 dB(1  $\mu$ V)EMF.

When the RF test loop is not activated, the signal level measured at the receiver input shall not exceed -27 dB(1  $\mu$ V)EMF at any frequency.

The RF test loop shall be controlled by the MTX via actual channel line and CU. The measurement itself is performed by MTX. The RF test loop may be common for several equipments.

The output from the transmitter to the RF test loop shall be available for local measurements of carrier frequency. The level at this output shall be -20 dBm +1,5 dB.

The RF test loop shall be connected/disconnected within 100 ms after received order.

It is recommended that there are two lamp indicators on the RF test loop. One yellow indicator indicates that the unit has power and one red indicator indicates that the RF test loop is activated.

## ANNEX 1

A CALCULATION OF SOME CRITICAL PARAMETERS IN THE COMBINING EQUIPMENT (Clause 3) IN RELATION TO THE TRANSMITTER/RECEIVER - REQUIREMENTS (Clause 4 and 5).



1. Summary of RF-requirements for TRANSMITTER (clause 4)

	dBm	dB/1 uV EMI
1 a. (§4.4) RF-carrier power: $P_{out} = 50W \pm 1 \text{ dB}, \dots$	+ 47	
1 b. (§4.5) Carrier off condition for		
$f = f_0: \leq 0,25 \text{ uW}, \dots$	- 36	
$f \neq f_0: \leq 2 \text{ nW}, \dots$	- 57	
$f_0$ is nominal transmitter frequency.		
1 c. (§4.6) Spurious emissions at :		
100kHz-2000MHz : $\leq 0,25 \text{ uW}, \dots$	- 36	
except $f_0 \pm 50\text{kHz}$ : $\leq 1,0 \text{ uW}, \dots$	- 30	v
1 d. (§4.7) Intermod. attenuation:		
$A_T \geq 15 \text{ dB},$		
$A_{T5} (453,0-457,5\text{MHz}) \geq 40 \text{ dB}$		
that is $f_1 - f_2 \geq 2,75 \text{ MHz}.$		
1 e. (§4.12) Adjacent channel power: $\leq -70 \text{ dB}/P_{out} \dots$	- 23	
$f_0 \pm 25 \text{ kHz}.$		
1 f. (§4.13) Noise power within receiver-band		
453,0 - 457,5 MHz: $\leq 2 \text{ nW}, \dots$	- 57	

2. Summary of RF-requirements for RECEIVER (clause 5)

		dBm	dB/1uV EMI
2 a. (§5.3)	RF-sensitivity : $\leq - 2$ dB/1 uV EMF,....	- 115	- 2
2 b. (§5.4)	Co-channel rejection: $\geq - 8$ dB/rel. 3a,..	- 123	- 10
2 c. (§5.5)	Adjacent channel select.: $\geq 75$ dB/1uV,.... $f_0 \pm 25$ kHz, $f_0$ is nominal receiver freq.	- 38	+ 75
2 d. (§5.6)	Spurious response rejection: $\geq 80$ dB/1uV,.. 100kHz-2000MHz.	- 33	+ 80
2 e. (§5.7)	Intermodulation response for unwanted test signals at $f_0 \pm x$ , $x \geq 50$ kHz: $\geq 80$ dB/1uV,.....	- 33	+ 80
2 f. (§5.8)	Blocking or desensitization: $\geq 100$ dB/1uV,.. $f_0 \pm 1$ MHz to $f_0 \pm 10$ MHz.	- 13	+100
2 g. (§5.9)	Spurious emissions at 453,0-457,5MHz : $\leq 0,025$ pW,.....	- 106	
	100kHz-2000MHz elsewhere : $\leq 2$ nW,...	- 57	

1981-11-19

———— Requirements to Transmitter.

- - - - Requirements to Receiver.

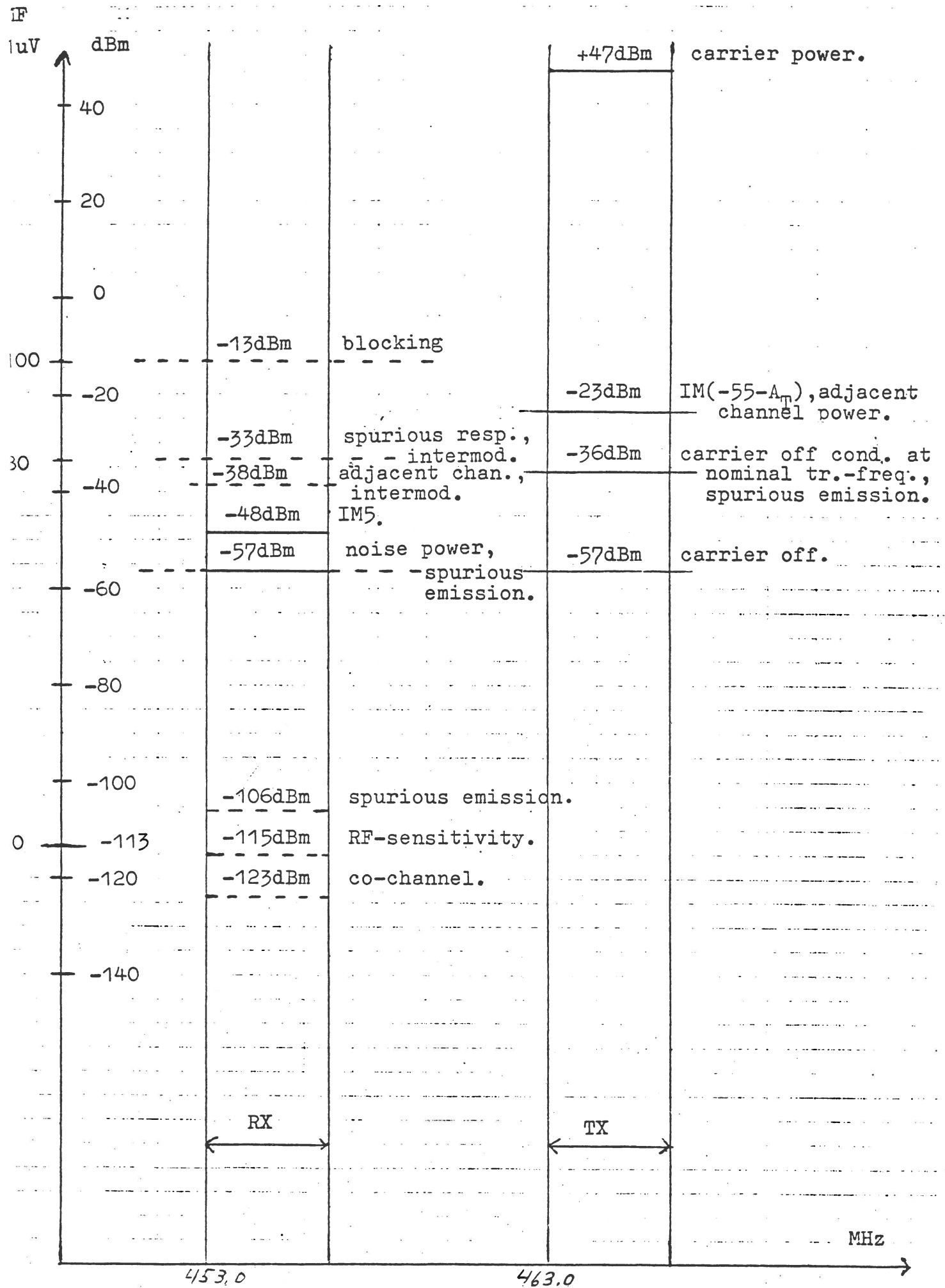

DB - BUDGET for critical parameters in COMBINING EQUIPMENT in relation to TRANSMITTER/RECEIVER-requirements.

In the following text the requirements to transmitter, receiver and combining equipment marked with (x) can differ from the figures stated below when a complete base station system is delivered from one manufacturer. In this case the total sum of the individual figures shall still be fulfilled.

3. TRANSMITTER COMBINER (clause 3.1..)

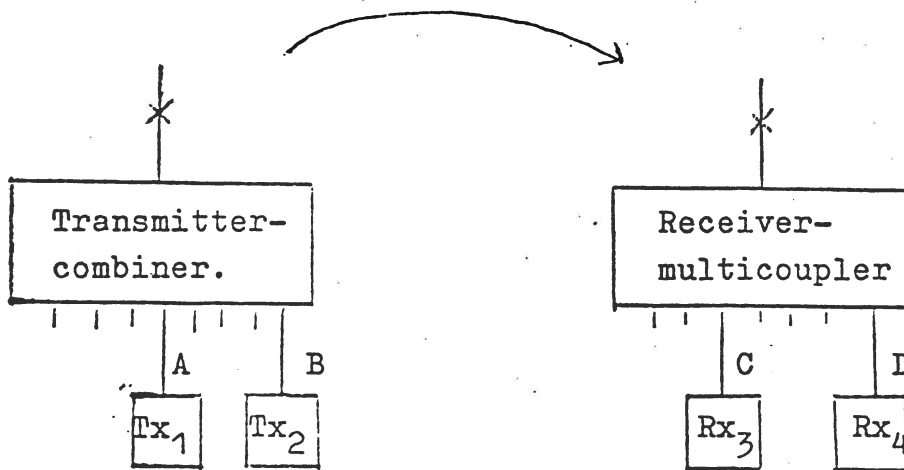

3a. Primary requirement: Transmitter intermod. attenuation, 5th. order (1d)

	RF-carrier power, point A or B :	+47dBm
(§3.1.9)	Isolation combiner A to B for $\Delta f \geq 175\text{kHz}$ :	55dB
(§4.7)	5.th. order intermod. attenuation in receiver-band (453,0-457,5MHz) :	40dB
	IM5 in receiver-band at point A or B:	-48dBm
(§3.1.12)	Attenuation of receiver-frequency through the combiner:	45dB
	Attenuation between transmitter/receiver-antennas:	30dB
(§3.2.7)	Gain through receiver-multicoupler :	- 1dB
	Attenuation in cables :	2dB
	IM5 in receiver frequency range at receiver-input, point C or D:	-124dBm

Co-channel rejection at receiver input (3b): = 123 dBm

The frequency-separation between  $Tx_1$  and  $Tx_2$  ( $f$ )  $\geq 2.750$  MHz to give IM5 in receiver-band.

At extreme test conditions the IM5 in receiver frequency range at receiver input shall not exceed +114 dBm.

3b. Primary requirement: Transmitter intermod. attenuation,  
-----3.th. order (1d)-----

	RF-carrier power, point A or B:	+47 dBm
	Isolation combiner A to B:	55 dB
(§ 4.7)	3.th. order intermod. attenuation:	15 dB
	IM3 at point A or B:	-23 dBm
	Attenuation of IM3 through the combiner:	5 dB
	IM3 at combiner output terminal:	<u>+28 dBm</u>

At extreme test conditions the IM3 at combiner output terminal shall not exceed +22 dBm.

3c. Primary requirement: Noise power within receiver band (1f)

(§ 4.13)	Noise power:	-57 dBm
	Attenuation of receiver-frequency through the combiner:	45 dB
	Attenuation between transmitter/receiver-antennas:	30 dB
(§ 3.2.7)	Gain through receiver-multicoupler:	- 1 dB
	Attenuation in cables:	2 dB
	Noise power from transmitter at receiver-input:	<u>-133 dBm</u>
	Co-channel rejection:	-123 dBm
	Compensation for 8 transmitters:	9 dB
	Requirement to noise power from 1 transmitter	<u>-132 dBm</u>

At extreme test conditions the noise power from one transmitter at receiver input shall not exceed -125 dBm.

## 4. RECEIVER MULTICOUPLER (clause 3.2..)

4a. Primary requirement: RF-carrier power (/a) and  
 -----  
Input filter at receiver multicoupler.

RF-carrier power at point A or B: +47dBm

(§3.1.7) Attenuation through the combiner, typical : 3dB

Attenuation between trans./receiv.-antennas: 30dB

Attenuation in cables 2dB

(§3.2.6) Attenuation of transmitter-frequency through  
 input filter : 60dB

Carrier power from transmitter at receiver  
 input point C or D: -48dBm

Spurious response rejection, intermoda response: -33dBm

The attenuation of 60dB through the input filter is  
 maintained to protect against other communication-systems  
 on the same site.

4b. Primary requirement: Spurious emissions from receiver  
 -----  
within receiver-band (2g).

(§ 5.9) Spurious emissions from receiver  
 within receiver band : -106dBm

(§3.2.8) Isolation multicoupler C to D : 25dB

Spurious from one receiver (Rx<sub>4</sub>) at  
 another receiver input (Rx<sub>3</sub>): -131dBm

Co-channel rejection : -123dBm

Compensation for 7 receivers: 8,5dB ⇒ 8dB

Requirements to spurious from 1 receiver  
 at another receiver input : -131

At extreme test conditions the spurious from one receiver at  
 another receiver input shall not exceed +125 dBm.

A1:8

4c. Primary requirement: Intermod. response for receiver (2e)  
and Intermod. response for multicoupler

Intermod. response for receiver :	-33dBm
Gain through multicoupler:	-1dB
Testsignal -level at multicoupler input.:	-34dBm
	-----
RF-sensitivity of the receiver (point C/D) :	-115dBm
Co-channel rejection :	-123dBm
Margin for the multicoupler :	2dB
Maximum level of the intermod. products from the multicoupler :	-125dBm
	-----

Hence two testsignals with the level -34dBm  
at multicoupler input shall at multicoupler  
output give:

testsignals of -33dBm  
IM.products of -125dBm

or testsignal/IM-product = 92dB

To facilitate the measurements the testsignals  
are increased with 16 dB which give:

Level of testsignals at multicoupler input:	- 18dBm
Testsignals at multicoupler output :	- 17dBm
IM-product (3. order): -125dBm + 3x16dB =	- 77dBm
Level of IM-product relative to testsignals at multicoupler output :	<u>- 60dB</u>

## 5. DUPLEX - FILTER (clause 3.3..)

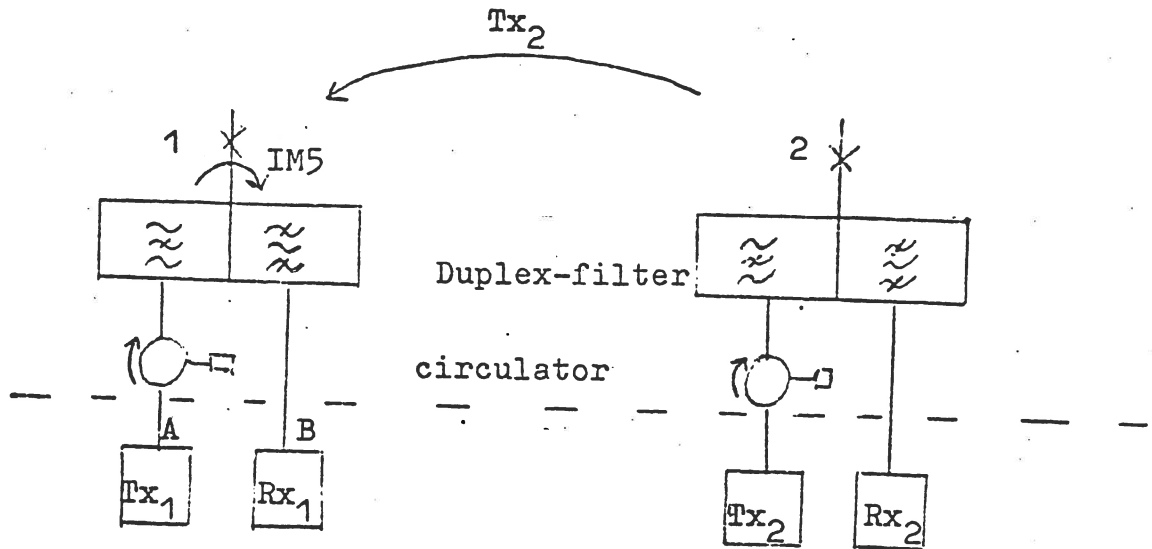

## TRANSMITTER-BRANCH:

5a. Primary requirement: Transmitter intermod. attenuation

5.th. order (1d)

RF-carrier power at point A:	+47dBm
Attenuation between antenna 1 and 2 :	30dB
(§ 3.3.8) Loss in duplex-filter 1 and 2, and circulator 2 :	3dB
Loss in cables :	2dB
(§3.3.9) Attenuation of Tx <sub>2</sub> through circulator 1 :	25dB
5.th. order intermod. attenuation in receiver band :	40dB
IM5 at point A :	-53dBm
Loss in circulator 1 at receiver frequency:	2dB
(§3.3.8) Attenuation of receiver-frequency in transmitter branch of duplex-filter :	75dB
Loss in receiver branch, typical :	1dB
IM5 in receiver frequency range at receiver input, point B:	<u><u>-131 dBm</u></u>
Co-channel rejection :	-123dBm
Margin for duplexfilter :	8dB
Requirement to IM5 at receiver input :	<u><u>-131dBm</u></u>

At extreme test conditions the IM5 in receiver frequency range at receiver input shall not exceed +121 dBm.



5b. Primary requirement: Transmitter intermod. attenuation,  
 3.th. order (1d)  
 -----

RF-carrier power at point A:	+47 dBm
Attenuation and loss between Tx <sub>2</sub> and duplex filter terminal of circulator 1:	35 dB
Attenuation of Tx <sub>2</sub> through circulator 1:	25 dB
3.th.order intermod. attenuation:	15 dB
Attenuation of IM3 through <del>circulator and duplex</del> filter 1:	0 dB
IM3 at antenna terminal of the duplex filter:	<u>-28 dBm</u>

At extreme test conditions the IM3 at antenna terminal of  
 the duplex filter shall not exceed +22 dBm.

5c. Primary requirement: Noise power from transmitter  
 within receiver band (1f)  
 -----

(§ 4.13) Noise power:	-57 dBm
Loss in circulator at receiver frequency	2 dB
Attenuation of receiver-frequency in transmitter branch:	75 dB
(§ 3.3.10) Loss in receiver branch, typical:	1 dB
Noise power from transmitter at receiver input, point B:	<u>-135 dBm</u>
Co-channel rejection:	<u>-123 dBm</u>

At extreme test conditions noise power from transmitter  
 at receiver input shall not exceed -127 dBm.

## RECEIVER-BRANCH:

5d. Primary requirement: RF-carrier power (1a) and  
Attenuation in receiver branch

	RF-carrier power at point A:	+47 dBm
	Loss in duplex-filter and circulator:	1.5 dB
(§ 3.3.10)	Attenuation of transmitter-frequency in receiver branch:	80 dB
	Carrier power from transmitter at receiver input, point B:	<u><u>-34.5 dBm</u></u>
	Spurious response rejection, intermod. response:	<u><u>-33 dBm</u></u>

At extreme test conditions the carrier power at receiver input shall not exceed -28 dBm.

-----

