

# NORDIC

---

# MOBILE TELEPHONE

 **telia mobitel**

 **TELE DANMARK  
MOBIL**

 **TELE**

 **Telenor Mobil**



**Technical Specification for  
Signalling System no. 7 HUP**

NMT Doc. 900 - 2, Annex 3-II  
Nordic Mobile Telephone Group  
Nordic No. 7 Signalling Group

7 edition  
December 1992

Automatic Cellular Mobile Telephone System

NORDIC

---

NMT - 900

TECHNICAL SPECIFICATION FOR  
SIGNALLING SYSTEM NO. 7  
HANDOVER USER PART

@ 1990. The copyright on the specifications herein is the property of Telecom Denmark, the General Directorate of Post and Telecommunications, Finland, the Norwegian Telecommunications Administration, Norway, and the Swedish Telecommunications Administration, Sweden. The specifications may be used/or copied by written permission only.

C O N T E N T S

1	INTRODUCTION . . . . .	1
1.2	Abbreviations . . . . .	2
2	BASIC FORMATS . . . . .	3
2.1	Message Signal Unit Format . . . . .	3
2.1.1	The Service Information Octet (SIO) . . . . .	4
2.1.2	Telephone Label . . . . .	5
2.1.2.1	Label Format . . . . .	5
2.1.2.1.1	Handover messages . . . . .	5
2.1.2.1.2	Handover measurement group of messages . . . . .	5
2.1.2.2	Destination and origination point codes . . . . .	6
2.1.2.3	Circuit Identification Code . . . . .	6
2.1.2.4	Logical Channel Code . . . . .	6
2.2	Format principles for HUP . . . . .	7
2.2.1	Mandatory Subfields . . . . .	7
2.2.2	Optional Subfields . . . . .	7
2.2.3	Fixed Length Subfields . . . . .	7
2.2.4	Variable Length Subfields . . . . .	7
2.2.5	Order of Subfield Transmission . . . . .	8
2.2.6	Order of Bit transmission . . . . .	8
2.2.7	Coding of Spare Bits . . . . .	8
3	MTP PROCEDURES FOR HUP . . . . .	9
4	FORMATS AND CODES . . . . .	10
4.1	General . . . . .	10
4.2	Heading Codes . . . . .	10
4.2.1	Abbreviations used in the table: . . . . .	12

4.3	Forward Handover Messages . . . . .	13
4.3.1	Traffic Channel Request Message (TCR) . . . . .	14
4.3.2	Tariff Class Transfer Message (TTM) . . . . .	19
4.3.3	Subsequent Handover Acknowledge Message (SHA) . . . . .	20
4.4	Backward Handover Messages . . . . .	21
4.4.1	Traffic Channel Acknowledge Message (TCA) . . . . .	22
4.4.2	Tariff Class Transfer Acknowledge Message (TTA) . . . . .	23
4.4.3	Subsequent Handover Request Message (SHM) . . . . .	24
4.4.4	Switching Successful Indication Message (SSI) . . . . .	26
4.5	Unsuccessful Handover Messages . . . . .	27
4.5.1	Traffic Channel not Available Message (TCN) . . . . .	28
4.5.2	Switching not Successful Indication Message (SSN) . . . . .	29
4.5.3	Call Failure Message (CFL) . . . . .	30
4.5.4	Subsequent Handover Rejected Message (SHR) . . . . .	31
4.6	Call Supervision Messages . . . . .	32
4.6.1	Subscriber Termination Message (STE) . . . . .	33
4.6.2	Clear Forward Message (CLF) . . . . .	34
4.6.3	Change Traffic Direction Message (CTD) . . . . .	35
4.6.4	Register Recall Message (RRM) . . . . .	36
4.6.5	Register Recall Acknowledge Message (RRA) . . . . .	37
4.6.5.1	Register Recall Acknowledge 2 Message (RRA2) . . . . .	38
4.6.6	Register Recall with Added Security Message (RAS) . . . . .	39
4.6.7	Register Recall Address Complete Message (RAC) . . . . .	40
4.6.8	Register Recall Digit Message (RDG) . . . . .	41
4.6.9	Register Recall Reject Message (RRR) . . . . .	42
4.6.10	MFT Converter Activation Request Message (MFM) . . . . .	43
4.6.11	MFT Converter Order Message (MFO) . . . . .	44

4.6.12	MFT Converter Activation Reject Message (MFR)	45
4.6.13	MFT Converter Deactivated Message (MFD)	46
4.7	Circuit Supervision Messages	47
4.7.1	Release Guard Message (RLG)	48
4.7.2	Blocking Message (BLO)	49
4.7.3	Blocking Acknowledgement Message (BLA)	50
4.7.4	Unblocking Message (UBL)	51
4.7.5	Unblocking Acknowledgement Message (UBA)	52
4.7.6	Reset Circuit Message (RSC)	53
4.8	Handover Measurement group of Messages	54
4.8.1	Signal Strength Measurement Order Message (SMO)	55
4.8.2	Signal Strength Measurement Acknowledge Message (SMA)	57
4.8.3	Signal Strength Measurement Rejected Message (SMR)	61
4.8.4	Handover Offer Message (HOM)	62
5	HANDOVER PROCEDURES	64
5.1	Measurement procedure	64
5.2	Basic Handover procedure	67
5.3	Subsequent Handover procedure	73
5.3.1	Subsequent handover from MTX-2 to MTX-1	73
5.3.2	Subsequent handover from MTX-2 to MTX-3	79
5.3.3	Handover offer procedure from MTX-OF to MTX-A, MTX-B, ...	86
5.4	Tariff Class transfer during an external handover	89
5.4.1	Delayed transfer of the Tariff Class Transfer Message	91
5.5	MFT Converter Activation during external handover	91
5.6	Register Recall during external handover	92
5.6.1	Change of traffic direction	97

5.7	Handling of messages . . . . .	98
5.7.1	Clear forward - Release guard sequences . . . . .	98
5.7.2	Reset circuit sequences . . . . .	98
5.7.3	Blocking - Unblocking sequences . . . . .	99
5.7.4	Dual seizure . . . . .	99
5.7.4.1	Detection of dual seizure . . . . .	100
5.7.4.2	Method to prevent dual seizure . . . . .	100
5.7.4.3	Actions to be taken in case of dual seizure . . . . .	100
5.7.5	Automatic repeat attempt . . . . .	100
5.7.6	Normal release sequences . . . . .	101
5.7.6.1	Release of outgoing connection . . . . .	101
5.7.6.2	Release of incoming connection . . . . .	101
5.7.7	Abnormal release sequences . . . . .	101
5.7.7.1	Inability to release in response to a CLF message	101
5.7.7.2	Inability to release in response to a TCN, SSN, CFL or STE message . . . . .	101
5.7.7.3	Reception of TCR in the pumping state . . . . .	102
5.7.8	Handling of abnormal or unreasonable signalling infor- mation . . . . .	102
5.8	Time Supervision . . . . .	105
5.8.1	Timers for Basic Handover . . . . .	106
5.8.2	Timers for Subsequent Handover from MTX-2 to MTX-1	107
5.8.3	Timers for Subsequent Handover from MTX-2 to MTX-3	108
5.8.4	Timer for Register Recall during external handover	108
5.8.5	Timer for MFT Converter activation during external handover . . . . .	109
5.8.6	Timer for Tariff Class Transfer . . . . .	109
5.8.7	Timers for Circuit Time Supervisions . . . . .	110
5.8.8	Timers for Call Time Supervision . . . . .	111

5.8.9	Timer for Handover Measurements . . . . .	112
5.8.10	Handling of unavailable destinations . . . . .	113
5.8.11	State Transition Diagrams . . . . .	114
5.8.11.1	General . . . . .	114
5.8.11.2	Drafting conventions . . . . .	115
6	HUP-MTP INTERFACE . . . . .	141
6.1	Transfer of HUP information . . . . .	141
6.2	Definitions . . . . .	141
6.3	Signalling Point Code assignment . . . . .	141
6.4	Primitives . . . . .	141
6.4.1	MTP-TRANSFER-Primitives . . . . .	141
6.4.2	MTP-PAUSE, MTP-RESUME primitives . . . . .	141
6.5	HUP Signalling Congestion Control . . . . .	142
7	FUNCTIONS FOR OPERATION AND MAINTENANCE OF THE HUP .	143
7.1	General . . . . .	143
7.2	Supervision functions . . . . .	143
7.3	Statistics and measurements . . . . .	143



NT/HANDOVER USER PART ADDENDUM TO MOBILE USER PART SPECIFICATION FOR NMT-900	Date: 1992-12-21	Edition: 7	Page: 1
--	---------------------	---------------	------------

## 1 INTRODUCTION

### 1.1 General

This technical specification defines the requirements for Signalling System No. 7 Handover User Part (HUP) for the Nordic Mobile Telephone system NMT-900 as defined in NMT Doc.900-2. This signalling can also be used in the NMT-450 system.

The purpose of this specification is to define the signalling required for performing handover of calls between neighbouring NMT Mobile Telephone Exchanges (MTXs). The signalling system described in this document refers only to the signalling between nodes interconnected with direct circuits. The signalling is conveyed via the national signalling networks. This means that handover is only allowed between MTXs in the same country.

The HUP shall be considered as an interim specification to provide the handover function between base stations connected to different MTXs. The long term solution is to use circuits switched through the telephone network for handover. The handover procedure will then be included in the MUP, and it must therefore be possible to use both HUP and the full implementation of MUP for handover at the same time in an MTX.

NT/HANDOVER USER PART ADDENDUM TO MOBILE USER PART SPECIFICATION FOR NMT-900	Date: 1992-12-21	Edition: 7	Page: 2
--	---------------------	---------------	------------

## 1.2 Abbreviations

The abbreviations used for messages and signals are defined in paragraph 4.2.1.

BS	Base Station
CCITT	The International Telegraph and Telephone Consultative Committee
CEPT	Conference Europeenne des Administrations des Postes et des Telecommunications
DPC	Destination Point Code
MS	Mobile Station
MSU	Message Signal Unit
MTP	Message Transfer Part
MUP	Mobile User Part
HUP	Handover User Part
MTX	Mobile Telephone Exchange
NMT	Nordic Mobile Telephone System
OPC	Originating Point Code
SCCP	Signalling Connection Control Part
TC	Traffic channel
TUP	Telephone User Part
ϕ signal	Supervisory signal

NT/HANDOVER USER PART ADDENDUM TO MOBILE USER PART SPECIFICATION FOR NMT-900	Date: 1992-12-21	Edition: 7	Page: 3
--	---------------------	---------------	------------

## 2 BASIC FORMATS

### 2.1 Message Signal Unit Format

Signalling originating from the HUP is transferred over the signalling link by means of message signal units (MSU).

A message signal unit is constituted of a variable length signalling information field which carries the information generated by the user part and of a number of fixed length fields which carry information required for message transfer control.

The general structure of the HUP messages is illustrated by figure 2.1.

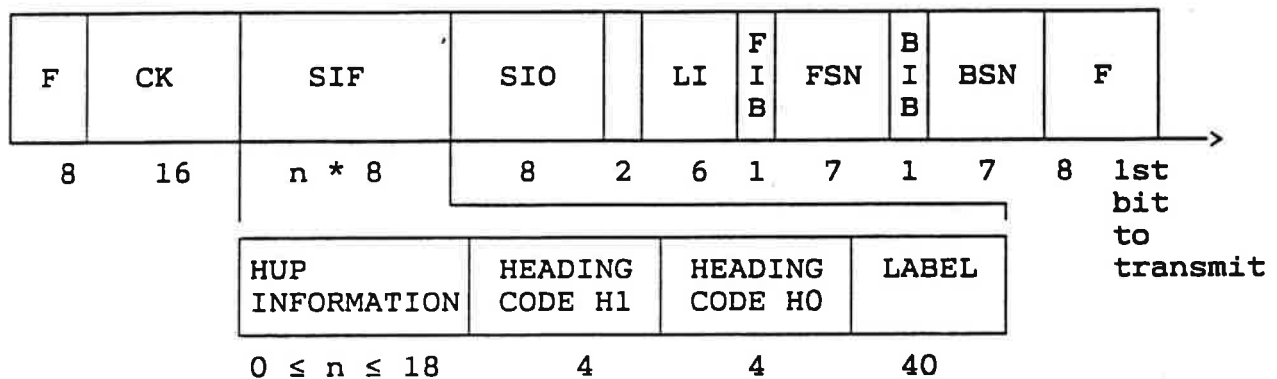

F Flag  
BSN Backward Sequence Number  
BIB Backward Indicator Bit  
FSN Forward Sequence Number  
FIB Forward Indicator Bit  
LI Length Indicator  
SIO Service Information Octet  
SIF Signalling Information Field  
CK Check Bits

Figure 2.1. General format of HUP messages.

NT/HANDOVER USER PART ADDENDUM TO MOBILE USER PART SPECIFICATION FOR NMT-900	Date: 1992-12-21	Edition: 7	Page: 4
--	---------------------	---------------	------------

### 2.1.1 The Service Information Octet (SIO)

The service information octet comprises the service indicator and the sub service field.

The service indicator is used to associate signalling information with the HUP function.

The information in the sub service field discriminates national and international signalling messages.

The format of the service information octet is shown in figure 2.2.

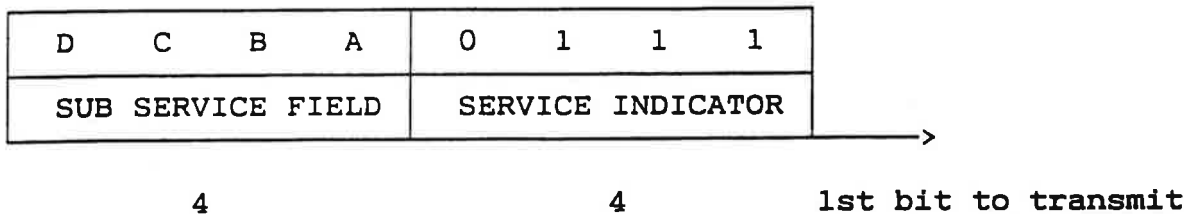

Figure 2.2 Service information octet.

For signalling messages generated by the HUP, the following codes are used in the field of the service information octet:

- i) the service indicator is coded 0111.
- ii) sub service field

bits BA: spare

bits DC: network indicator

- 00 International network
- 01 Spare (for international use only)
- 10 National network
- 11 Spare (reserved for national use)

Since the HUP only will be used for national signalling relations, only the national codes will be used.

NT/HANDOVER USER PART ADDENDUM TO MOBILE USER PART SPECIFICATION FOR NMT-900	Date: 1992-12-21	Edition: 7	Page: 5
--	---------------------	---------------	------------

## 2.1.2 Telephone Label

### 2.1.2.1 Label Format

#### 2.1.2.1.1 Handover messages

For the Handover messages, the CCITT standard label is used.

The label has a length of 40 bits and is placed at the beginning of the signalling information field (SIF). The label structure is shown in figure 2.3.

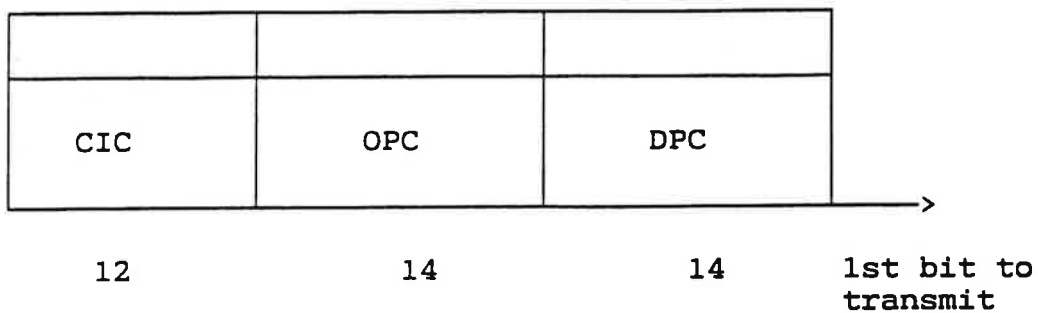

Figure 2.3. Label structure.

The Destination Point Code (DPC) indicates the signalling point for which the message is intended, while the Origination Point Code (OPC) indicates the source of the message. The Circuit Identification Code (CIC) uniquely identifies the circuit used for the call.

#### 2.1.2.1.2 Handover measurement group of messages

For the Handover measurement group of messages, a modified CCITT standard label is used.

The length and organization is identical to the label described for Handover messages, except the CIC code which is substituted with a Logical Channel Code (LOC). The LOC indicates a logical channel identified by a transaction number.

NT/HANDOVER USER PART ADDENDUM TO MOBILE USER PART SPECIFICATION FOR NMT-900	Date: 1992-12-21	Edition: 7	Page: 6
--	---------------------	---------------	------------

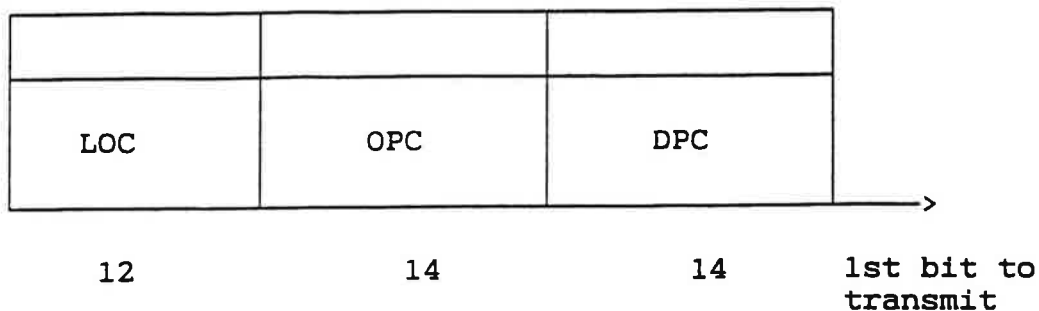

Figure 2.4. Label structure.

#### 2.1.2.2 Destination and origination point codes

The standard label structure requires that each telephone exchange in its role as signalling point is allocated a code from code plans established for the purpose of signalling points.

Separate code plans are used for the international signalling network and for different national signalling networks.

#### 2.1.2.3 Circuit Identification Code

The Circuit Identification Code indicates the circuit used for the call. For every signal used for a specific call, the Circuit Identification Code is used to identify the call amongst the other.

The four least significant bits in the Circuit Identification Code are used for identifying one among several systems interconnecting an origination and a destination point.

#### 2.1.2.4 Logical Channel Code

The Logical Channel Code indicates a logical channel identified by a Transaction Number allocated to the forward signal by the initiating exchange. The same LOC is used for the related backward signal.

The four least significant bits in the Logical Channel Code are used for identifying one among several systems interconnecting an origination and a destination point.

NT/HANDOVER USER PART ADDENDUM TO MOBILE USER PART SPECIFICATION FOR NMT-900	Date: 1992-12-21	Edition: 7	Page: 7
--	---------------------	---------------	------------

## 2.2 Format principles for HUP

The HUP generated information is divided into a number of subfields which may be either of fixed or variable length. For a given message type identified by a unique message heading, the presence of a given subfield may be either mandatory or optional.<sup>1</sup>

### 2.2.1 Mandatory Subfields

Subfields which have been declared mandatory for a given message type appear in all messages of that type.

### 2.2.2 Optional Subfields

Subfields which have been declared optional for a given message type only appear when required in messages of that type. The presence or absence of each optional field is indicated by the state of a field indicator located in an indicator field, which in this case is a mandatory subfield.

### 2.2.3 Fixed Length Subfields

Subfields which have been declared fixed length for a given message type contain the same number of bits in all messages of that type.

### 2.2.4 Variable Length Subfields

For subfields which have been declared variable length for a given message type the number of bits may vary between messages of that type. The size of a variable length subfield is indicated in an immediately preceding fixed length subfield.

---

<sup>1</sup> In the present specification, only mandatory subfields are used.

NT/HANDOVER USER PART ADDENDUM TO MOBILE USER PART SPECIFICATION FOR NMT-900	Date: 1992-12-21	Edition: 7	Page: 8
--	---------------------	---------------	------------

### 2.2.5 Order of Subfield Transmission

For a given type of message the various types of subfields are transmitted in the following order:

- i) mandatory subfields
- ii) optional subfields

Within each of these two classes, the order of subfield transmission is, in general, as follows:

- a) fixed length subfields
- b) variable length subfields

### 2.2.6 Order of Bit transmission

Within each defined subfield the information is transmitted with the least significant bit first.

### 2.2.7 Coding of Spare Bits

Spare bits are coded 0 unless indicated otherwise.



NT/HANDOVER USER PART ADDENDUM TO MOBILE USER PART SPECIFICATION FOR NMT-900	Date: 1992-12-21	Edition: 7	Page: 9
--	---------------------	---------------	------------

### **3 MTP PROCEDURES FOR HUP**

In principle this is a national matter. However, since the Nordic Administrations aims to have the same software packages in all MTXs, the MTP should fulfil the CCITT Red Book Recommendations for international operation.

NT/HANDOVER USER PART ADDENDUM TO MOBILE USER PART SPECIFICATION FOR NMT-900	Date: 1992-12-21	Edition: 7	Page: 10
--	---------------------	---------------	-------------

## **4 FORMATS AND CODES**

### **4.1 General**

All messages in the Handover User Part contain a label and a heading consisting of two parts, heading code H0 and heading code H1. Code H0 identifies a specific message group while H1 contains a signal code.

### **4.2 Heading Codes**

The heading code H0 occupies the 4-bit field following the label and is coded as follows:

- 1010 Forward Handover Messages (FHM),
- 1011 Backward Handover Messages (BHM),
- 1100 Unsuccessful Handover Messages (UHM),
- 1101 Call Supervision Messages (CSM),
- 1110 Circuit Supervision Messages (SCM),
- 1111 Handover Measurement group of Messages (HMM).

In table 4.1 all HUP messages and the corresponding heading codes are listed.

Mes- sage Group	H1 H0	0000	0001	0010	0011	0100	0101	0110	0111
		0000 TO 1001							
FHM	1010		TCR	TTM	SHA				
BHM	1011		TCA	TTA	SHM	SSI			
UHM	1100		TCN	SSN	CFL	SHR			
CSM	1101		STE	CLF	CTD	RRM	RRA	RAS	RAC
SCM	1110		RLG	BLO	BLA	UBL	UBA	RSC	
HMM	1111		SMO	SMA	SMR	HOM			

Mes- sage Group	H1 H0	1000	1001	1010	1011	1100	1101	1110	1111
		0000 TO 1001							
FHM	1010								
BHM	1011								
UHM	1100								
CSM	1101	RDG	RRR	MFM	MFO	MFR	MFD	RRA2	
SCM	1110								
HMM	1111								

Table 4.1 HUP Message Heading Code Allocation.

NT/HANDOVER USER PART ADDENDUM TO MOBILE USER PART SPECIFICATION FOR NMT-900	Date: 1992-12-21	Edition: 7	Page: 12
--	---------------------	---------------	-------------

#### 4.2.1 Abbreviations used in the table:

BHM Backward Handover Messages  
 BLA Blocking Acknowledged Message  
 BLO Blocking Message  
 CFL Call Failure Message  
 CLF Clear Forward Message  
 CSM Call Supervision Messages  
 CTD Change Traffic Direction Message  
 FHM Forward Handover Messages  
 HMM Handover Measurement Messages  
 HOM Handover Offer Message  
 MFD MFT Converter Deactivated Message  
 MFM MFT Converter Activation Request Message  
 MFO MFT Converter Order Message  
 MFR MFT Converter Activation Reject Message  
 RAC Register Recall Address Complete Message  
 RAS Register Recall with Added Security Message  
 RDG Register Recall Digit Message  
 RLG Release Guard Message  
 RRA Register Recall Acknowledge Message  
 RRA2 Register Recall Acknowledge 2 Message  
 RRM Register Recall Message  
 RRR Register Recall Reject Message  
 RSC Reset Circuit Message  
 SCM Circuit Supervision Messages  
 SHA Subsequent Handover Acknowledged Message  
 SHM Subsequent Handover Request Message  
 SHR Subsequent Handover Rejected Message  
 SMA Signal Strength Measurement Acknowledge Message  
 SMO Signal Strength Measurement Order Message  
 SMR Signal Strength Measurement Rejected Message  
 SSI Switching Successful Indication Message  
 SSN Switching Not Successful Indication Message  
 STE Subscriber Termination Message  
 TCA Traffic Channel Acknowledgement Message  
 TCN Traffic Channel Not Available Message  
 TCR Traffic Channel Request Message  
 TTA Tariff Class Transfer Acknowledge Message  
 TTM Tariff Class Transfer Message  
 UBA Unblocking Acknowledged Message  
 UBL Unblocking Message  
 UHM Unsuccessful Handover Messages

NT/HANDOVER USER PART ADDENDUM TO MOBILE USER PART SPECIFICATION FOR NMT-900	Date: 1992-12-21	Edition: 7	Page: 13
--	---------------------	---------------	-------------

### **4.3 Forward Handover Messages**

The following types of Forward Handover Messages are included in the HUP and are each identified by a different heading code H1.

- 4.3.1 Traffic Channel Request Message (TCR),
- 4.3.2 Tariff Class Transfer Message (TTM),
- 4.3.3 Subsequent Handover Acknowledged Message (SHA).

NT/HANDOVER USER PART ADDENDUM TO MOBILE USER PART SPECIFICATION FOR NMT-900	Date: 1992-12-21	Edition: 7	Page: 14
--	---------------------	---------------	-------------

#### 4.3.1 Traffic Channel Request Message (TCR)

The basic format of the TCR is shown in figure 4.1.

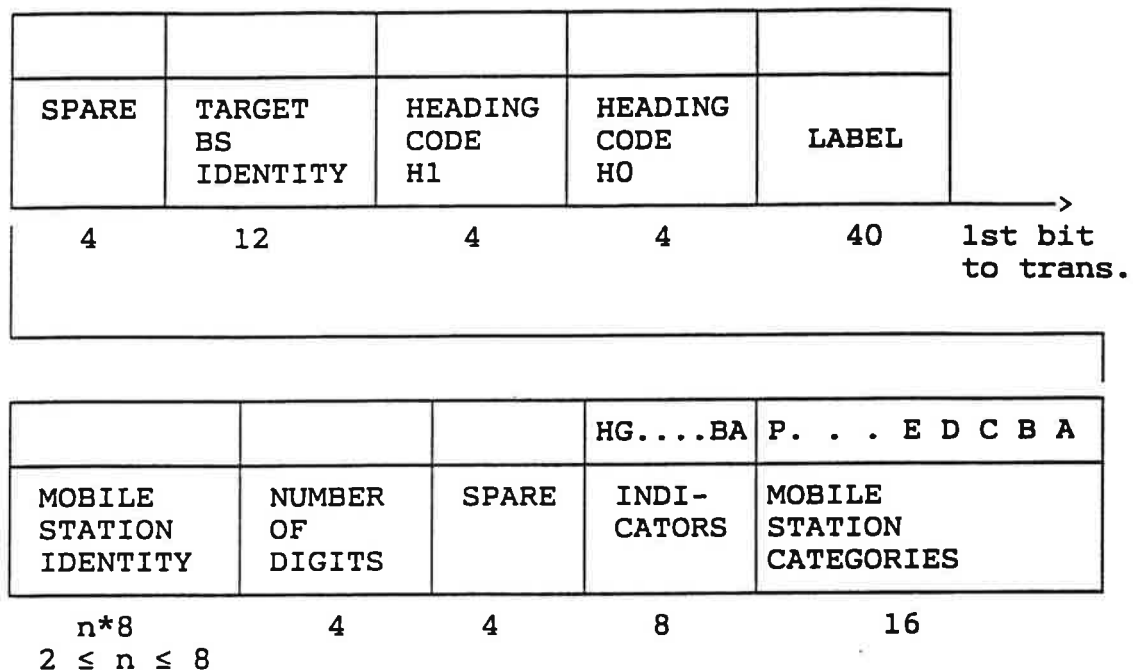

Figure 4.1. Traffic Channel Request Message.

The following codes are used in the fields of the Traffic Channel Request Message.

- a) Label. See paragraph 2.1.2.
- b) Heading code H0 is coded 1010
- c) Heading code H1 is coded 0001
- d) Target Base station identity ( $B_1B_2B_3$ )

The identity of the new base station chosen by the Measurement procedure.

Coding of this information as in paragraph j).

- e) Spare

NT/HANDOVER USER PART ADDENDUM TO MOBILE USER PART SPECIFICATION FOR NMT-900	Date: 1992-12-21	Edition: 7	Page: 15
--	---------------------	---------------	-------------

f) Mobile station categories

Coding of these indicators has the following meaning:

0: Service not activated  
 1: Service activated

Bit A: Type of mobile station.

Not activated: Not handheld.  
 Activated: Handheld

Bit B: Battery saving.

Not activated: No battery saving  
 Activated: MS with battery saving

Bit C: Added Mobile Identity Security

Not activated: The mobile station is not  
 equipped with Added Security.  
 Activated: The mobile station is equipped  
 with Added Security.

Bit D: Payphone

Not activated: No payphone.  
 Activated: Payphone.

Bit E: Priority

Not activated: Not priority.  
 Activated: Priority.

Bit F: Official

Not activated: Not official.  
 Activated: Official.

NT/HANDOVER USER PART ADDENDUM TO MOBILE USER PART SPECIFICATION FOR NMT-900	Date: 1992-12-21	Edition: 7	Page: 16
--	---------------------	---------------	-------------

Bit G: Bearer service

Not activated: Speech  
 Activated: Data + speech

Bits IH: Mobile station signalling variant

00 not used value  
 01 Basic NMT-450 signalling  
 10 Basic NMT-900 signalling  
 11 NMT-450i signalling

The purpose of this category is to be able to perform appropriate signalling towards NMT-450i mobile stations. Special signalling procedures are used for example when switchable compander is available.

Bits PONMLKJ: spare

g) Indicators

Coding of these indicators have the following meaning:

Bit A: Queuing indicator

0: Queuing of the handover in the new MTX is allowed.  
 1: Queuing of the handover in the new MTX is not allowed.

Bit B: Traffic direction

0: Originating call  
 1: Terminating call



NT/HANDOVER USER PART ADDENDUM TO MOBILE USER PART SPECIFICATION FOR NMT-900	Date: 1992-12-21	Edition: 7	Page: 17
--	---------------------	---------------	-------------

Bit C: Immediate Call Diversion.

This indicator indicates the status of the services:

- "Incoming Call Barred"
- "Immediate Call Diversion"
- "Don't disturb"

0: Not activated

1: Activated

Bit D: Reserved

Bit HGFE: Spare.

h) Spare

i) Number of digits.

A code expressing in pure binary representation the number of digits signals contained in the following sub-field.

NT/HANDOVER USER PART ADDENDUM TO MOBILE USER PART SPECIFICATION FOR NMT-900	Date: 1992-12-21	Edition: 7	Page: 18
--	---------------------	---------------	-------------

j) Mobile Station Identity ( $ZX_1 \dots X_6 K_1 K_2 K_3$ )

The digit signals are coded as shown below. The most significant digit is sent first. Subsequent digits are sent in successive 4-bit fields.

```

0000 digit 0
0001 digit 1
0010 digit 2
0011 digit 3
0100 digit 4
0101 digit 5
0110 digit 6
0111 digit 7
1000 digit 8
1001 digit 9
1010 Code 10
1011 Code 11
1100 Code 12
1101 Code 13
1110 Code 14
1111 Code 15

```

Note: Filler

The filler 0000 is inserted after the last digit signal in case of an odd number of digit signals. This ensures that this variable length field consists of an integer number of octets.

NT/HANDOVER USER PART ADDENDUM TO MOBILE USER PART SPECIFICATION FOR NMT-900	Date: 1992-12-21	Edition: 7	Page: 19
--	---------------------	---------------	-------------

#### 4.3.2 Tariff Class Transfer Message (TTM)

The basic format of the TTM is shown in figure 4.2.

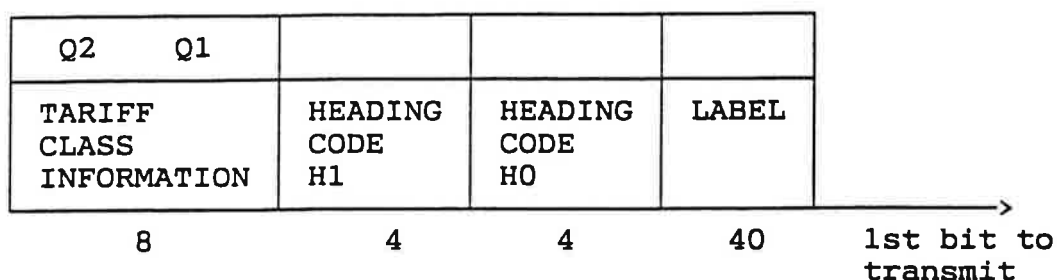

Figure 4.2. Tariff Class Transfer Message.

The following codes are used in the fields of the Tariff Class Transfer Message:

- a) Label. See paragraph 2.1.2.
- b) Heading code H0 is coded 1010
- c) Heading code H1 is coded 0010
- d) Tariff Class information  $Q_1$ ,  $Q_2$ .

Two digits in hexadecimal representation indicating the tariff class information to the MS.

NT/HANDOVER USER PART ADDENDUM TO MOBILE USER PART SPECIFICATION FOR NMT-900	Date: 1992-12-21	Edition: 7	Page: 20
--	---------------------	---------------	-------------

### 4.3.3 Subsequent Handover Acknowledge Message (SHA)

The basic format of the SHA is shown in figure 4.3.

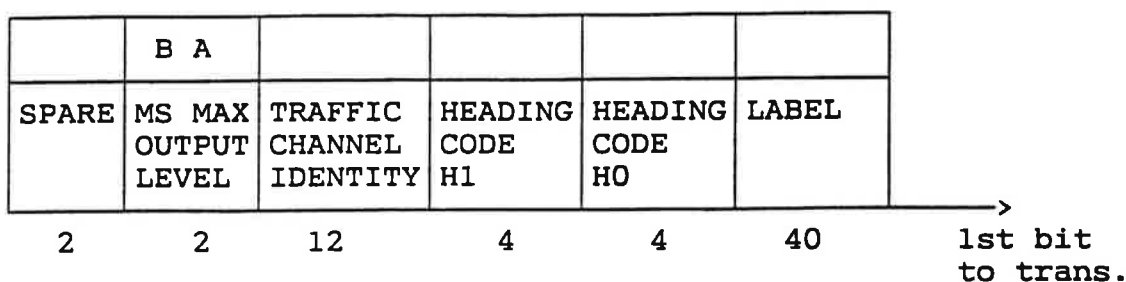

Figure 4.3. Subsequent Handover Acknowledge Message.

The following codes are used in the fields of the Subsequent Handover Acknowledge Message:

- a) Label. See paragraph 2.1.2.
- b) Heading code H0 is coded 1010
- c) Heading code H1 is coded 0011
- d) Traffic Channel Identity (NaNbNc)

A 12 bit binary representation of the Traffic Channel Identity of the new traffic channel.

- e) Mobile Station Output Level

The power bits indicating which maximum power level the mobile station shall be ordered to before it tunes to the new traffic channel. The coding of these bits has the following meaning:

BA  
00 Low power  
01 Medium power  
10 High power, umbrella BS  
11 High power

- f) Spare

NT/HANDOVER USER PART ADDENDUM TO MOBILE USER PART SPECIFICATION FOR NMT-900	Date: 1992-12-21	Edition: 7	Page: 21
--	---------------------	---------------	-------------

#### **4.4 Backward Handover Messages**

The following types of Backward Handover Messages are included in the HUP and are each identified by a different heading code H1.

- 4.4.1 Traffic Channel Acknowledge Message (TCA),
- 4.4.2 Tariff Class Transfer Acknowledge Message (TTA),
- 4.4.3 Subsequent Handover Request Message (SHM),
- 4.4.4 Switching Successful Indication Message (SSI).

NT/HANDOVER USER PART ADDENDUM TO MOBILE USER PART SPECIFICATION FOR NMT-900	Date: 1992-12-21	Edition: 7	Page: 22
--	---------------------	---------------	-------------

#### 4.4.1 Traffic Channel Acknowledge Message (TCA)

The basic format of the TCA is shown in figure 4.4.

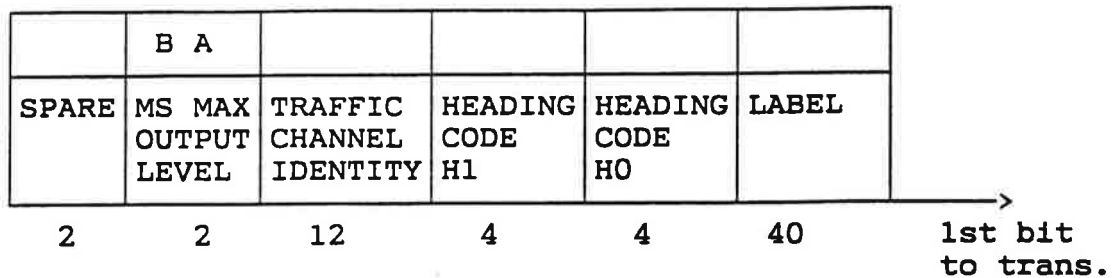

Figure 4.4. Traffic Channel Acknowledge Message.

The following codes are used in the fields of the Traffic Channel Acknowledge Message.

- a) Label: See paragraph 2.1.2.
- b) Heading code H0 is coded 1011
- c) Heading code H1 is coded 0001
- d) Traffic Channel Identity (NaNbNc). See paragraph 4.3.3.d.
- e) Mobile Station Output Level. See paragraph 4.3.3.e.
- f) Spare

NT/HANDOVER USER PART ADDENDUM TO MOBILE USER PART SPECIFICATION FOR NMT-900	Date: 1992-12-21	Edition: 7	Page: 23
--	---------------------	---------------	-------------

#### 4.4.2 Tariff Class Transfer Acknowledge Message (TTA)

The basic format of the TTA is shown in figure 4.5.

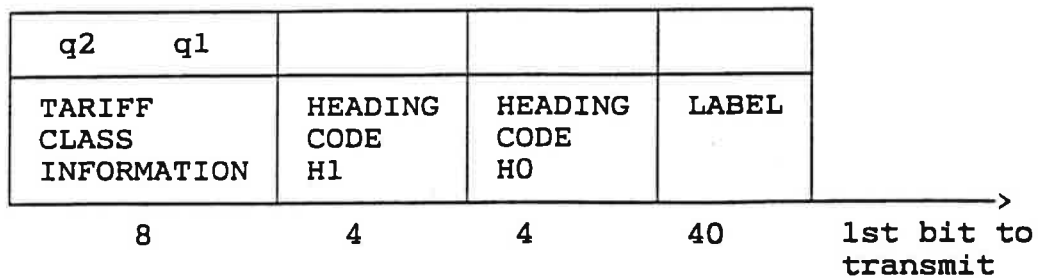

Figure 4.5. Tariff Class Transfer Acknowledge Message.

The following codes are used in the fields of the Tariff Class Transfer Acknowledge Message.

- a) Label: See paragraph 2.1.2.
- b) Heading code H0 is coded 1011
- c) Heading code H1 is coded 0010
- d) Tariff class information  $q_1$ ,  $q_2$  from MS.

Coding of this information as in paragraph 4.3.2.d. This is the response received from the MS.

NT/HANDOVER USER PART ADDENDUM TO MOBILE USER PART SPECIFICATION FOR NMT-900	Date: 1992-12-21	Edition: 7	Page: 24
--	---------------------	---------------	-------------

#### 4.4.3 Subsequent Handover Request Message (SHM)

The basic format of the SHM is shown in figure 4.6.

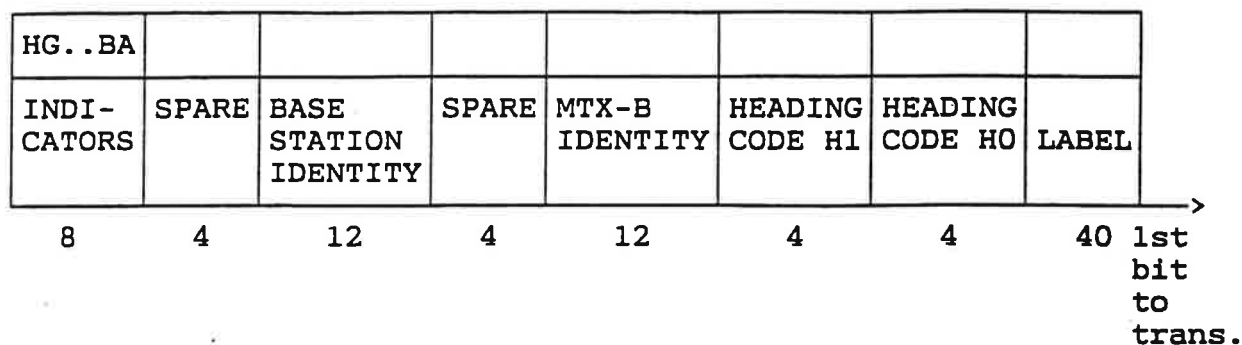

Figure 4.6. Subsequent Handover Request Message.

The following codes are used in the fields of the Subsequent Handover Request Message.

- a) Label: See paragraph 2.1.2.
- b) Heading code H0 is coded 1011
- c) Heading code H1 is coded 0011
- d) MTX-B Identity ( $Z'X_1'X_2'$ ).

This is the identity of the MTX which the call is going to be handed over to. MTX-B is chosen by the Measurement procedure.

Coding of this information as in paragraph 4.3.1.j.

- e) Spare
- f) Base station identity ( $B_1B_2B_3$ )

The identity of the new base station chosen by the Measurement procedure.

Coding of this information as in paragraph 4.3.1.j.

- g) Spare



NT/HANDOVER USER PART ADDENDUM TO MOBILE USER PART SPECIFICATION FOR NMT-900	Date: 1992-12-21	Edition: 7	Page: 25
--	---------------------	---------------	-------------

h) Indicators

Coding of these indicators has the following meaning:

Bit A: Queuing indicator

0: Queuing of the handover in the new MTX is allowed.

1: Queuing of the handover in the new MTX is not allowed.

Bit HGFEDCB: Spare.

NT/HANDOVER USER PART ADDENDUM TO MOBILE USER PART SPECIFICATION FOR NMT-900	Date: 1992-12-21	Edition: 7	Page: 26
--	---------------------	---------------	-------------

#### 4.4.4 Switching Successful Indication Message (SSI)

The basic format of the SSI is shown in figure 4.7.

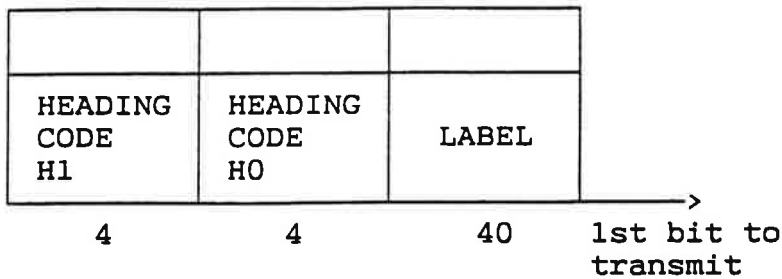

Figure 4.7. Switching Successful Indication Message.

The following codes are used in the fields of the Switching Successful Indication Message.

- a) Label: See paragraph 2.1.2.
- b) Heading code H0 is coded 1011
- c) Heading code H1 is coded 0100

NT/HANDOVER USER PART ADDENDUM TO MOBILE USER PART SPECIFICATION FOR NMT-900	Date: 1992-12-21	Edition: 7	Page: 27
--	---------------------	---------------	-------------

#### 4.5 Unsuccessful Handover Messages

The following types of Unsuccessful Handover Messages are included in the HUP and are each identified by a different heading code H1.

- 4.5.1 Traffic Channel Not Available Message (TCN),
- 4.5.2 Switching Not Successful Indication Message (SSN),
- 4.5.3 Call Failure Message (CFL),
- 4.5.4 Subsequent Handover Reject Message (SHR).

NT/HANDOVER USER PART ADDENDUM TO MOBILE USER PART SPECIFICATION FOR NMT-900	Date: 1992-12-21	Edition: 7	Page: 28
--	---------------------	---------------	-------------

#### 4.5.1 Traffic Channel not Available Message (TCN)

The basic format for the TCN is shown in figure 4.8.

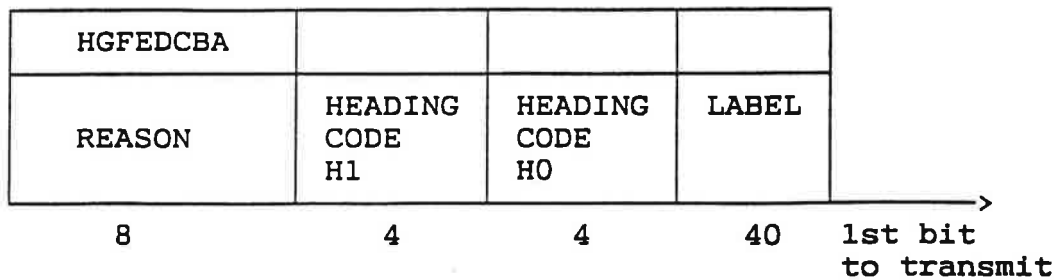

Figure 4.8. Traffic Channel not Available Message.

The following codes are used in the fields of the Traffic Channel not Available Message:

- a) Label. See paragraph 2.1.2.
- b) Heading code H0 is coded 1100
- c) Heading code H1 is coded 0001
- d) DCBA Reason

0000 No free traffic channel.  
0001 No existing base station.  
0010 Miscellaneous.

(The remaining codes are spare).

Bits HGFE: Spare.

NT/HANDOVER USER PART ADDENDUM TO MOBILE USER PART SPECIFICATION FOR NMT-900	Date: 1992-12-21	Edition: 7	Page: 29
--	---------------------	---------------	-------------

#### 4.5.2 Switching not Successful Indication Message (SSN)

The basic format of the SSN is shown in figure 4.9.

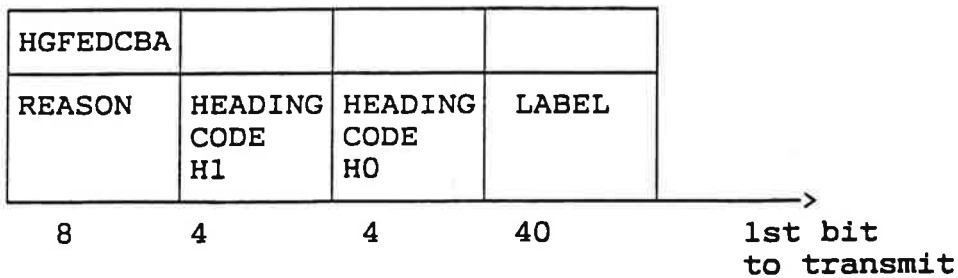

Figure 4.9. Switching not Successful Indication Message.

The following codes are used in the fields of the Switching not Successful Message:

- a) Label. See paragraph 2.1.2.
- b) Heading code H0 is coded 1100.
- c) Heading code H1 is coded 0010.
- e) Reason

DCBA  
0000 Timeout for traffic channel connection.  
0001 Miscellaneous

(The remaining codes are spare).

Bits HGFE: Spare.

NT/HANDOVER USER PART ADDENDUM TO MOBILE USER PART SPECIFICATION FOR NMT-900	Date: 1992-12-21	Edition: 7	Page: 30
--	---------------------	---------------	-------------

#### 4.5.3 Call Failure Message (CFL)

The basic format of the CFL is shown in figure 4.10.

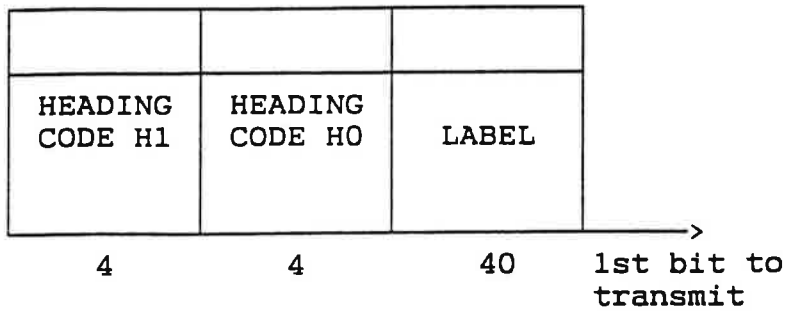

Figure 4.10. Call Failure Message.

The following codes are used in the fields of the Call Failure Message.

- a) Label: See paragraph 2.1.2.
- b) Heading code H0 is coded 1100
- c) Heading code H1 is coded 0011

NT/HANDOVER USER PART ADDENDUM TO MOBILE USER PART SPECIFICATION FOR NMT-900	Date: 1992-12-21	Edition: 7	Page: 31
--	---------------------	---------------	-------------

#### 4.5.4 Subsequent Handover Rejected Message (SHR)

The basic format for the SHR is shown in figure 4.11.

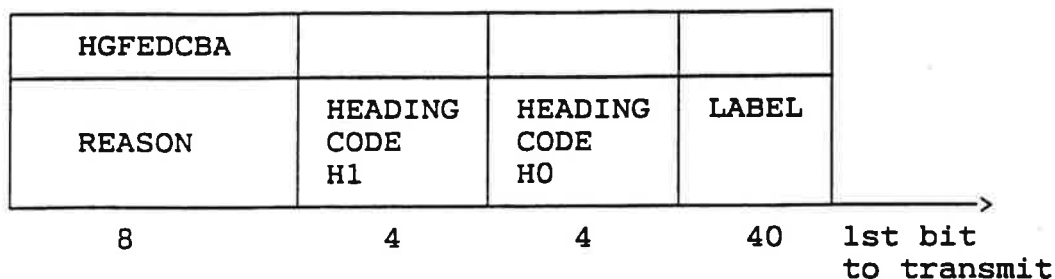

Figure 4.11. Subsequent Handover Rejected Message.

The following codes are used in the fields of the Subsequent Handover Rejected Message:

- a) Label. See paragraph 2.1.2.
- b) Heading code H0 is coded 1100.
- c) Heading code H1 is coded 0100.
- d) DCBA Reason

0000 No free traffic channel  
0001 Target BS unknown  
0010 Target MTX unknown  
0011 No handover circuit available  
0100 No handover circuits provided to target MTX  
0101 Miscellaneous

(The remaining codes are spare).

Bits HGFE: Spare.

NT/HANDOVER USER PART ADDENDUM TO MOBILE USER PART SPECIFICATION FOR NMT-900	Date: 1992-12-21	Edition: 7	Page: 32
--	---------------------	---------------	-------------

#### 4.6 Call Supervision Messages

The following types of Call Supervision Messages are included in the HUP and are each identified by a different heading code H1.

- 4.6.1 Subscriber Termination Message (STE),
- 4.6.2 Clear Forward Message (CLF),
- 4.6.3 Change Traffic Direction Message (CTD)
- 4.6.4 Register Recall Message (RRM),
- 4.6.5 Register Recall Acknowledge Message (RRA),
- 4.6.5.1 Register Recall Acknowledge 2 Message (RRA2),
- 4.6.6 Register Recall with Added Security Message (RAS),
- 4.6.7 Register Recall Address Complete Message (RAC),
- 4.6.8 Register Recall Digit Message (RDG),
- 4.6.9 Register Recall Reject Message (RRR),
- 4.6.10 MFT Converter Activation Request Message (MFM),
- 4.6.11 MFT Converter Order Message (MFO),
- 4.6.12 MFT Converter Activation Reject Message (MFR),
- 4.6.13 MFT Converter Deactivated Message (MFD).



NT/HANDOVER USER PART ADDENDUM TO MOBILE USER PART SPECIFICATION FOR NMT-900	Date: 1992-12-21	Edition: 7	Page: 33
--	---------------------	---------------	-------------

#### 4.6.1 Subscriber Termination Message (STE)

The basic format of the STE is shown in figure 4.12.

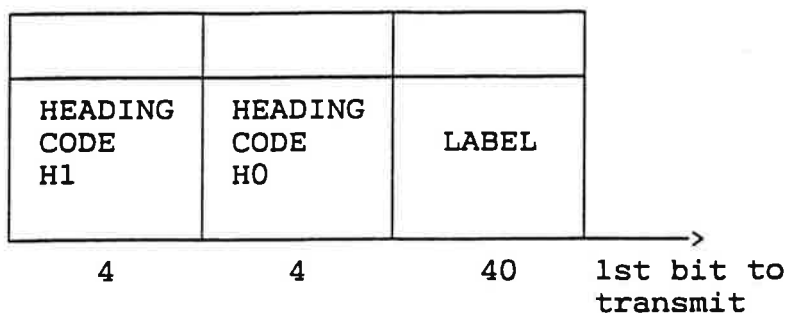

Figure 4.12. Subscriber Termination Message.

The following codes are used in the fields of the Subscriber Termination Message.

- a) Label: See paragraph 2.1.2.
- b) Heading code H0 is coded 1101
- c) Heading code H1 is coded 0001

NT/HANDOVER USER PART ADDENDUM TO MOBILE USER PART SPECIFICATION FOR NMT-900	Date: 1992-12-21	Edition: 7	Page: 34
--	---------------------	---------------	-------------

#### 4.6.2 Clear Forward Message (CLF)

The basic format of the CLF is shown in figure 4.13.

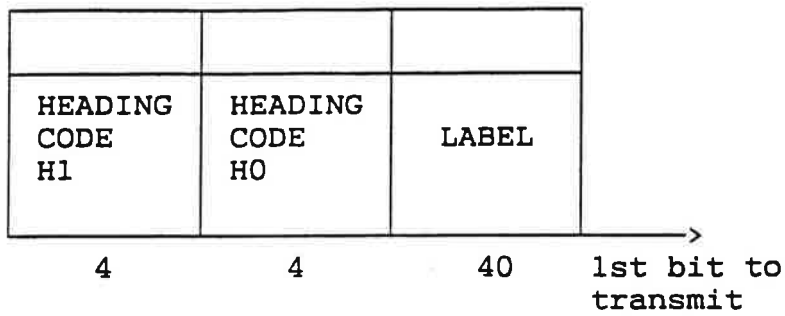

Figure 4.13. Clear Forward Message.

The following codes are used in the fields of the Clear Forward Message.

- a) Label: See paragraph 2.1.2.
- b) Heading code H0 is coded 1101
- c) Heading code H1 is coded 0010

NT/HANDOVER USER PART ADDENDUM TO MOBILE USER PART SPECIFICATION FOR NMT-900	Date: 1992-12-21	Edition: 7	Page: 35
--	---------------------	---------------	-------------

#### 4.6.3 Change Traffic Direction Message (CTD)

The basic format of the CTD is shown in figure 4.14.

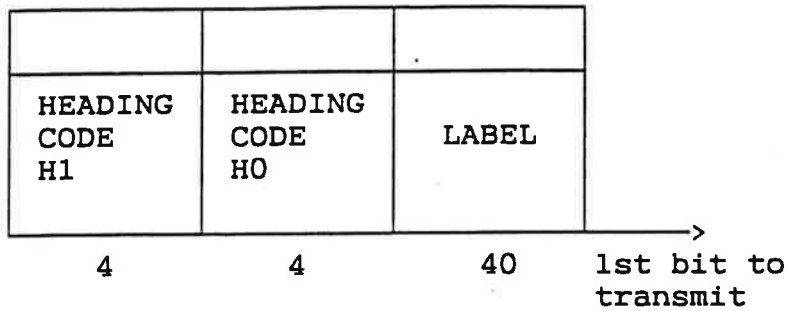

Figure 4.14. Change Traffic Direction Message.

The following codes are used in the fields of the Change Traffic Direction Message.

- a) Label: See paragraph 2.1.2.
- b) Heading code H0 is coded 1101
- c) Heading code H1 is coded 0011

NT/HANDOVER USER PART ADDENDUM TO MOBILE USER PART SPECIFICATION FOR NMT-900	Date: 1992-12-21	Edition: 7	Page: 36
--	---------------------	---------------	-------------

#### 4.6.4 Register Recall Message (RRM)

The basic format of the RRM is shown in figure 4.15.

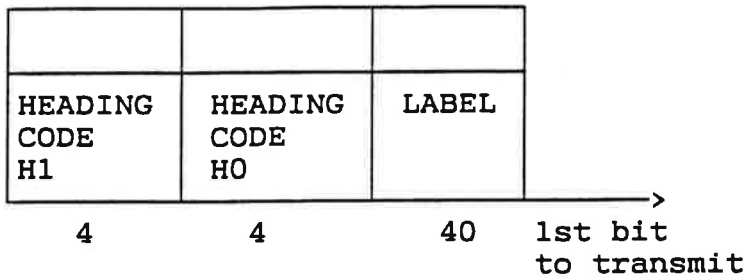

Figure 4.15. Register Recall Message.

The following codes are used in the fields of the Register Recall Message:

- a) Label. See paragraph 2.1.2.
- b) Heading code H0 is coded 1101.
- c) Heading code H1 is coded 0100.

NT/HANDOVER USER PART ADDENDUM TO MOBILE USER PART SPECIFICATION FOR NMT-900	Date: 1992-12-21	Edition: 7	Page: 37
--	---------------------	---------------	-------------

#### 4.6.5 Register Recall Acknowledge Message (RRA)

The basic format of the RRA is shown in figure 4.16.

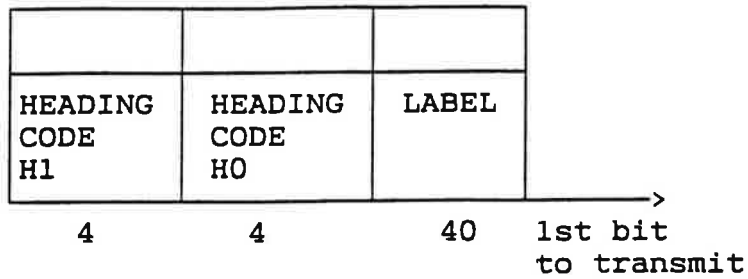

Figure 4.16. Register Recall Acknowledge Message.

The following codes are used in the fields of the Register Recall Acknowledge Message:

- a) Label. See paragraph 2.1.2.
- b) Heading code H0 is coded 1101.
- c) Heading code H1 is coded 0101.

NT/HANDOVER USER PART ADDENDUM TO MOBILE USER PART SPECIFICATION FOR NMT-900	Date: 1992-12-21	Edition: 7	Page: 38
--	---------------------	---------------	-------------

#### 4.6.5.1 Register Recall Acknowledge 2 Message (RRA2)

The basic format of the RRA2 is shown in figure 4.16a.

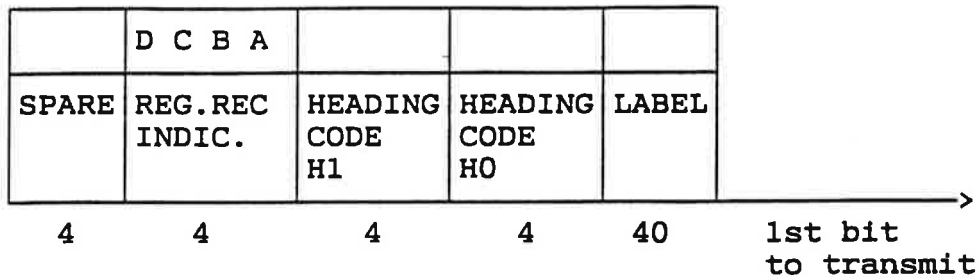

Figure 4.16a. Register Recall Acknowledge 2 Message.

The following codes are used in the fields of the Register Recall Acknowledge 2 Message:

- a) Label. See paragraph 2.1.2.
- b) Heading code H0 is coded 1101.
- c) Heading code H1 is coded 1110.
- d) Register Recall Indicators.

The coding of these indicators have the following meaning

Bit A:

- 0 : No dialling tone to be sent
- 1 : Dialling tone to be sent

Bits DCB : Spare

- e) Spare

#### 4.6.6 Register Recall with Added Security Message (RAS)

The basic format of the RAS is shown in figure 4.17.

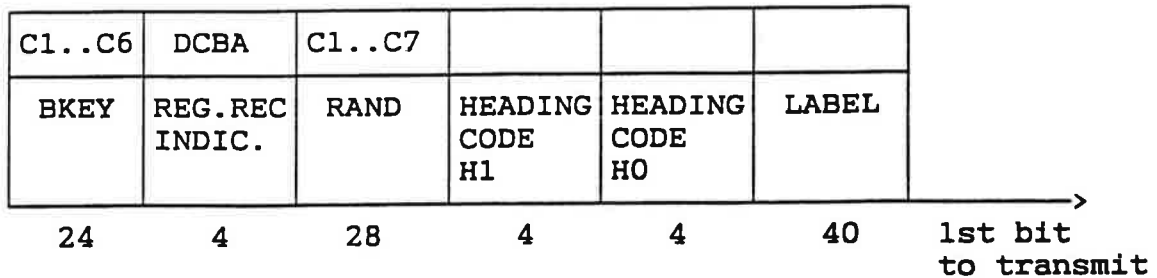

Figure 4.17. Register Recall with Added Security Message

The following codes are used in the fields of the Register Recall with Added Security Message:

- a) Label. See paragraph 2.1.2.
- b) Heading code H0 is coded 1101.
- c) Heading code H1 is coded 0110.
- d) RAND is a random number. It consists of seven succeeding digits (C1..C7). The digits are hexadecimal coded. The C7 digit is transferred first. Within each digit the least significant bit is transferred first.
- e) Register Recall Indicators.

The coding of these indicators has the following meaning:

Bit A:  
0 : No dialling tone to be sent  
1 : Dialling tone to be sent

Bits DCB: Spare

- f) BKEY is a key used to decrypt the B-number. The key is computed from RAND using the SAK. It consists of six succeeding digits (C1..C6). The digits are hexadecimal coded. The C6 digit is transferred first. Within each digit the least significant bit is transferred first.

NT/HANDOVER USER PART ADDENDUM TO MOBILE USER PART SPECIFICATION FOR NMT-900	Date: 1992-12-21	Edition: 7	Page: 40
--	---------------------	---------------	-------------

#### 4.6.7 Register Recall Address Complete Message (RAC)

The basic format of the RAC is shown in figure 4.18.

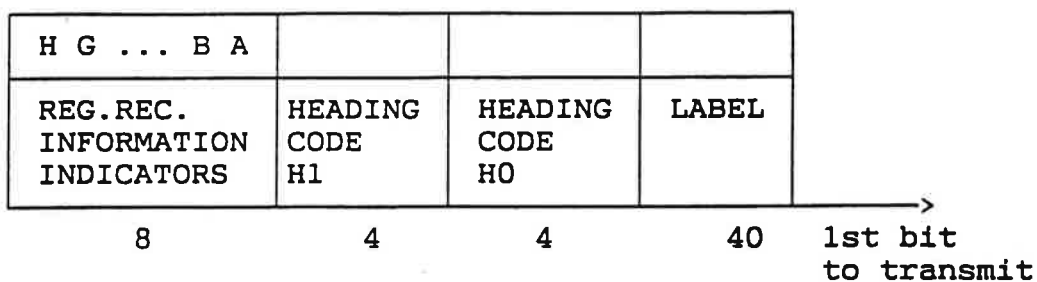

Figure 4.18. Register Recall Address Complete Message.

The following codes are used in the fields of the Register Recall Address Complete Message :

- a) Label. See paragraph 2.1.2.
- b) Heading code H0 is coded 1101.
- c) Heading code H1 is coded 0111.
- d) Register Recall Information Indicators.

The coding of these indicators have the following meaning:

0: Not activated  
1: Activated

Bit A: Dynamic data category  
Bit B: Immediate call transfer

Bit HGFEDC: Spare.



NT/HANDOVER USER PART ADDENDUM TO MOBILE USER PART SPECIFICATION FOR NMT-900	Date: 1992-12-21	Edition: 7	Page: 41
--	---------------------	---------------	-------------

#### 4.6.8 Register Recall Digit Message (RDG)

The basic format of the RDG is shown in figure 4.19.

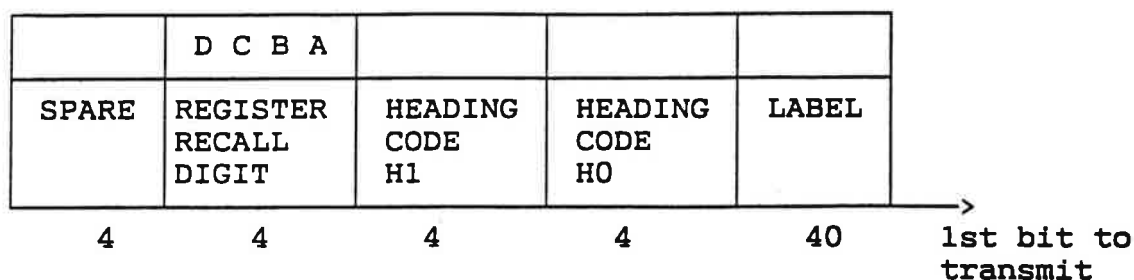

Figure 4.19. Register Recall Digit Message.

The following codes are used in the fields of the Register Recall Digit Message:

- a) Label. See paragraph 2.1.2.
- b) Heading code H0 is coded 1101.
- c) Heading code H1 is coded 1000.
- d) Register Recall Digit.  
Digit dialled by the subscriber after having activated the Register Recall procedure and after having received the Register Recall dialling tone. The coding of these information is shown below:

DCBA	
0000	digit 0
0001	digit 1
0010	digit 2
0011	digit 3
0100	digit 4
0101	digit 5
0110	digit 6
0111	digit 7
1000	digit 8
1001	digit 9
1010	A
1011	*
1100	#
1101	B
1110	C
1111	D

- e) Spare.

NT/HANDOVER USER PART ADDENDUM TO MOBILE USER PART SPECIFICATION FOR NMT-900	Date: 1992-12-21	Edition: 7	Page: 42
--	---------------------	---------------	-------------

#### 4.6.9 Register Recall Reject Message (RRR)

The basic format for the RRR is shown in figure 4.20.

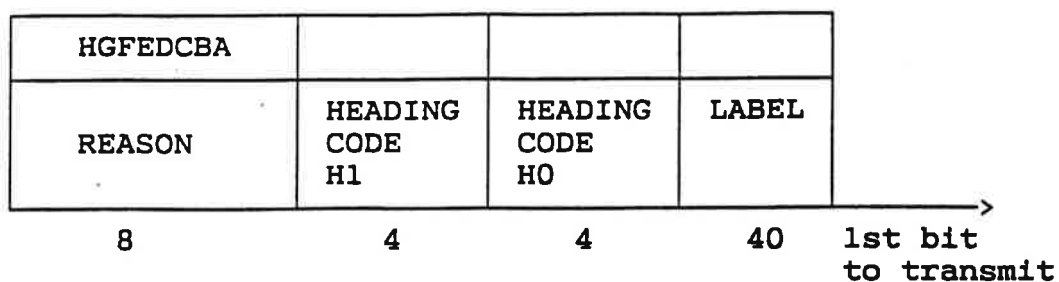

Figure 4.20. Register Recall Reject Message.

The following codes are used in the fields of the Register Recall Reject Message.

- a) Label. See paragraph 2.1.2.
- b) Heading code H0 is coded 1101.
- c) Heading code H1 is coded 1001.
- d) DCBA Reason

0000 No Security Data available  
0001 Miscellaneous.

(The remaining codes are spare).

Bits HGFE: Spare.

NT/HANDOVER USER PART ADDENDUM TO MOBILE USER PART SPECIFICATION FOR NMT-900	Date: 1992-12-21	Edition: 7	Page: 43
--	---------------------	---------------	-------------

#### 4.6.10 MFT Converter Activation Request Message (MFM)

The basic format for the MFM is shown in figure 4.21.

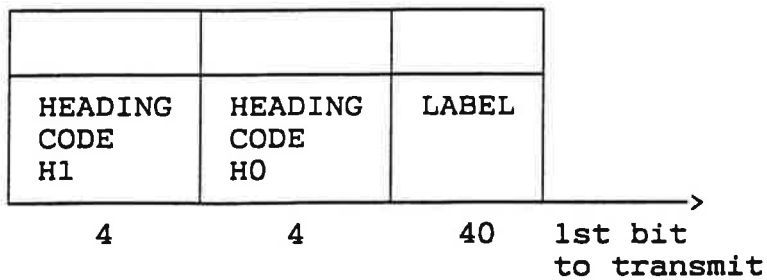

Figure 4.21. MFT Converter Activation Request Message.

The following codes are used in the fields of the MFT Converter Activation Request Message.

- a) Label. See paragraph 2.1.2.
- b) Heading code H0 is coded 1101.
- c) Heading code H1 is coded 1010.

NT/HANDOVER USER PART ADDENDUM TO MOBILE USER PART SPECIFICATION FOR NMT-900	Date: 1992-12-21	Edition: 7	Page: 44
--	---------------------	---------------	-------------

#### 4.6.11 MFT Converter Order Message (MFO)

The basic format for the MFO is shown in figure 4.22.

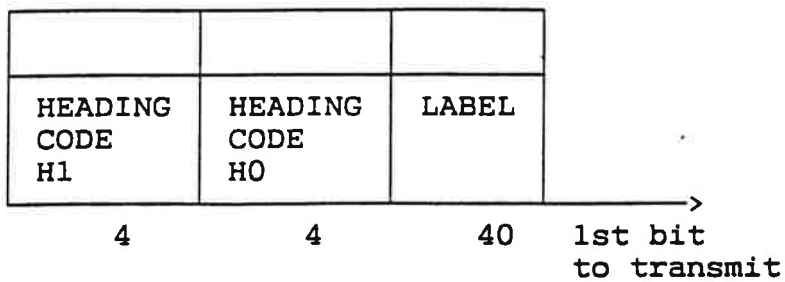

Figure 4.22. MFT Converter Order Message.

The following codes are used in the fields of the MFT Converter Order Message.

- a) Label. See paragraph 2.1.2.
- b) Heading code H0 is coded 1101.
- c) Heading code H1 is coded 1011.

NT/HANDOVER USER PART ADDENDUM TO MOBILE USER PART SPECIFICATION FOR NMT-900	Date: 1992-12-21	Edition: 7	Page: 45
--	---------------------	---------------	-------------

#### 4.6.12 MFT Converter Activation Reject Message (MFR)

The basic format for the MFR is shown in figure 4.23.

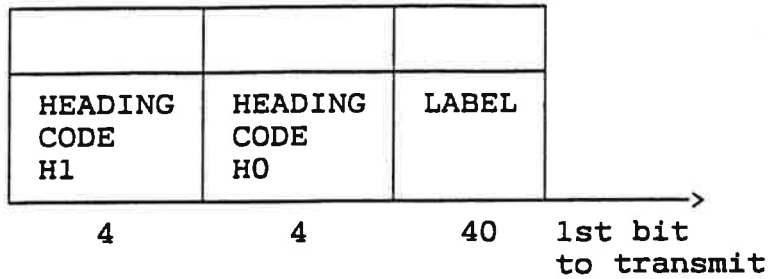

Figure 4.23. MFT Converter Activation Reject Message.

The following codes are used in the fields of the MFT Converter Activation Reject Message.

- a) Label. See paragraph 2.1.2.
- b) Heading code H0 is coded 1101.
- c) Heading code H1 is coded 1100.

NT/HANDOVER USER PART ADDENDUM TO MOBILE USER PART SPECIFICATION FOR NMT-900	Date: 1992-12-21	Edition: 7	Page: 46
--	---------------------	---------------	-------------

#### 4.6.13 MFT Converter Deactivated Message (MFD)

The basic format for the MFD is shown in figure 4.24.

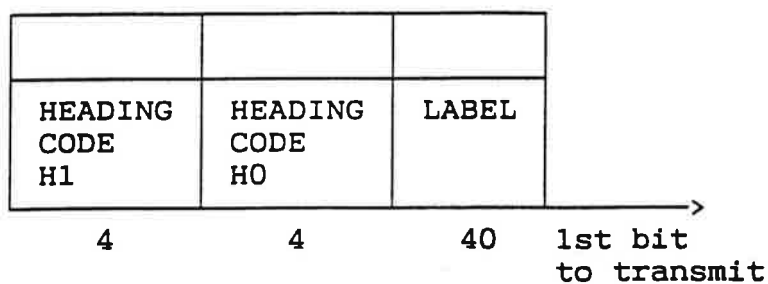

Figure 4.24. MFT Converter Deactivated Message.

The following codes are used in the fields of the MFT Converter Deactivated Message.

- a) Label. See paragraph 2.1.2.
- b) Heading code H0 is coded 1101.
- c) Heading code H1 is coded 1101.

NT/HANDOVER USER PART ADDENDUM TO MOBILE USER PART SPECIFICATION FOR NMT-900	Date: 1992-12-21	Edition: 7	Page: 47
--	---------------------	---------------	-------------

#### 4.7 Circuit Supervision Messages

The following types of Circuit Supervision Messages are included in the HUP and are each identified by a different heading code H1.

- 4.7.1 Release Guard Message (RLG),
- 4.7.2 Blocking Message (BLO),
- 4.7.3 Blocking Acknowledgement Message (BLA),
- 4.7.4 Unblocking Message (UBL),
- 4.7.5 Unblocking Acknowledgement Message (UBA),
- 4.7.6 Reset Circuit Message (RSC).

NT/HANDOVER USER PART ADDENDUM TO MOBILE USER PART SPECIFICATION FOR NMT-900	Date: 1992-12-21	Edition: 7	Page: 48
--	---------------------	---------------	-------------

#### 4.7.1 Release Guard Message (RLG)

The basic format of the RLG is shown in figure 4.25.

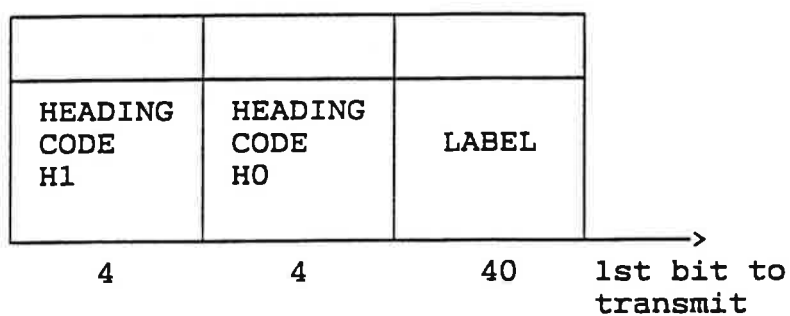

Figure 4.25. Release Guard Message.

The following codes are used in the fields of the Release Guard Message.

- a) Label: See paragraph 2.1.2.
- b) Heading code H0 is coded 1110
- c) Heading code H1 is coded 0001



NT/HANDOVER USER PART ADDENDUM TO MOBILE USER PART SPECIFICATION FOR NMT-900	Date: 1992-12-21	Edition: 7	Page: 49
--	---------------------	---------------	-------------

#### 4.7.2 Blocking Message (BL0)

The basic format of the BL0 is shown in figure 4.26.

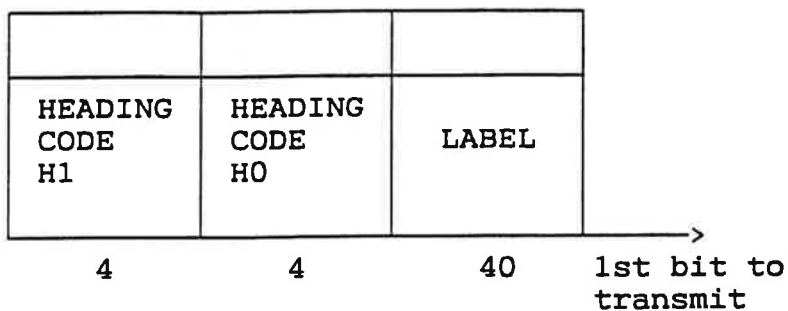

Figure 4.26. Blocking Message

The following codes are used in the fields of the Blocking Message.

- a) Label: See paragraph 2.1.2.
- b) Heading code H0 is coded 1110
- c) Heading code H1 is coded 0010

NT/HANDOVER USER PART ADDENDUM TO MOBILE USER PART SPECIFICATION FOR NMT-900	Date: 1992-12-21	Edition: 7	Page: 50
--	---------------------	---------------	-------------

### 4.7.3 Blocking Acknowledgement Message (BLA)

The basic format of the BLA is shown in figure 4.27.

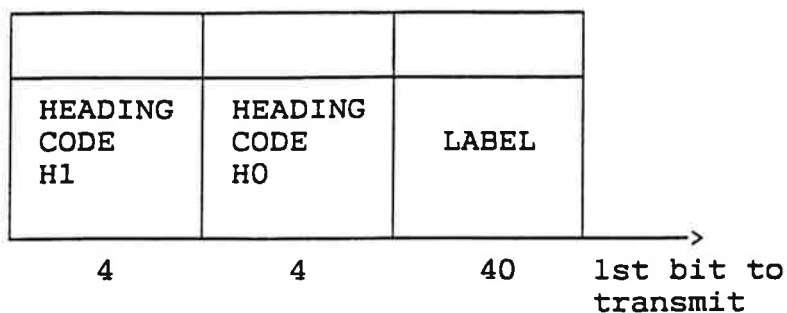

Figure 4.27. Blocking Acknowledgement Message.

The following codes are used in the fields of the Blocking Acknowledgement Message.

- a) Label: See paragraph 2.1.2.
- b) Heading code H0 is coded 1110
- c) Heading code H1 is coded 0011

NT/HANDOVER USER PART ADDENDUM TO MOBILE USER PART SPECIFICATION FOR NMT-900	Date: 1992-12-21	Edition: 7	Page: 51
--	---------------------	---------------	-------------

**4.7.4 Unblocking Message (UBL)**

The basic format of the UBL is shown in figure 4.28.

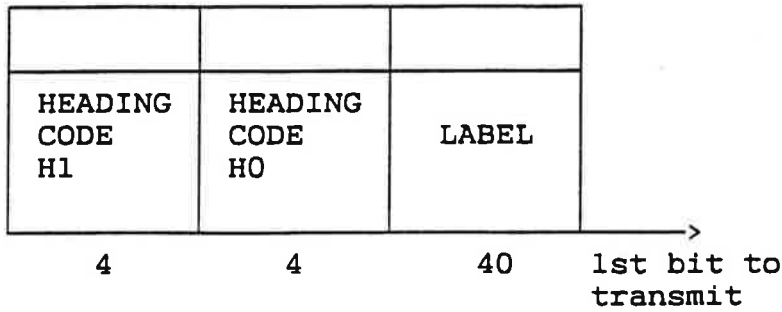

Figure 4.28. Unblocking Message.

The following codes are used in the fields of the Unblocking Message.

- a) Label: See paragraph 2.1.2.
- b) Heading code H0 is coded 1110
- c) Heading code H1 is coded 0100

NT/HANDOVER USER PART ADDENDUM TO MOBILE USER PART SPECIFICATION FOR NMT-900	Date: 1992-12-21	Edition: 7	Page: 52
--	---------------------	---------------	-------------

#### 4.7.5 Unblocking Acknowledgement Message (UBA)

The basic format of the UBA is shown in figure 4.29.

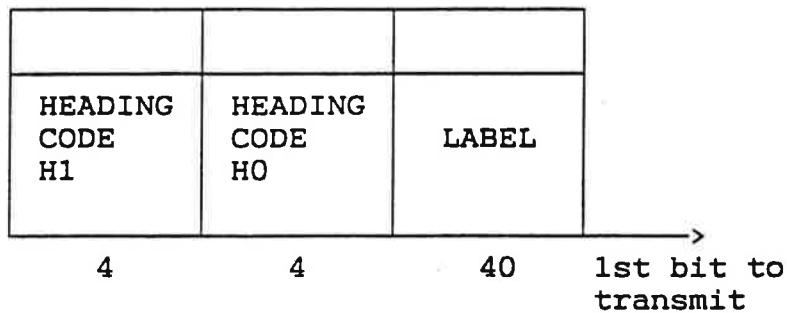

Figure 4.29. Unblocking Acknowledgement Message.

The following codes are used in the fields of the Unblocking Acknowledgement Message.

- a) Label: See paragraph 2.1.2.
- b) Heading code H0 is coded 1110
- c) Heading code H1 is coded 0101

NT/HANDOVER USER PART ADDENDUM TO MOBILE USER PART SPECIFICATION FOR NMT-900	Date: 1992-12-21	Edition: 7	Page: 53
--	---------------------	---------------	-------------

#### 4.7.6 Reset Circuit Message (RSC)

The basic format of the RSC is shown in figure 4.30.

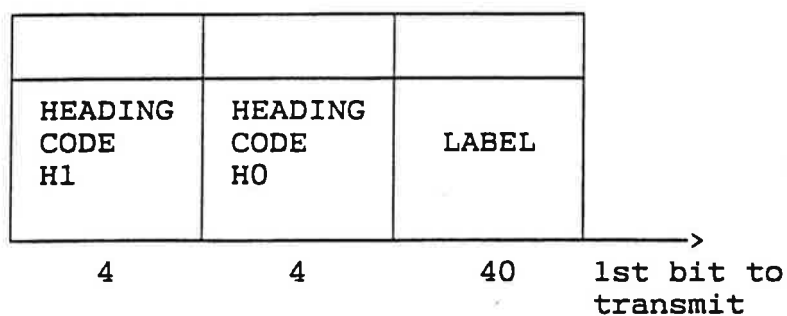

Figure 4.30. Reset Circuit Message.

The following codes are used in the fields of the Reset Circuit Message.

- a) Label: See paragraph 2.1.2.
- b) Heading code H0 is coded 1110
- c) Heading code H1 is coded 0110

NT/HANDOVER USER PART ADDENDUM TO MOBILE USER PART SPECIFICATION FOR NMT-900	Date: 1992-12-21	Edition: 7	Page: 54
--	---------------------	---------------	-------------

#### **4.8 Handover Measurement group of Messages**

The following types of Handover Measurement group of Messages are included in the HUP and are each identified by a different heading code H1.

- 4.8.1 Signal Strength Measurement Order Message (SMO),
- 4.8.2 Signal Strength Measurement Acknowledge Message (SMA),
- 4.8.3 Signal Strength Measurement Rejected Message (SMR),
- 4.8.4 Handover Offer Message (HOM).

#### 4.8.1 Signal Strength Measurement Order Message (SMO)

The basic format of the SMO is shown in figure 4.31.

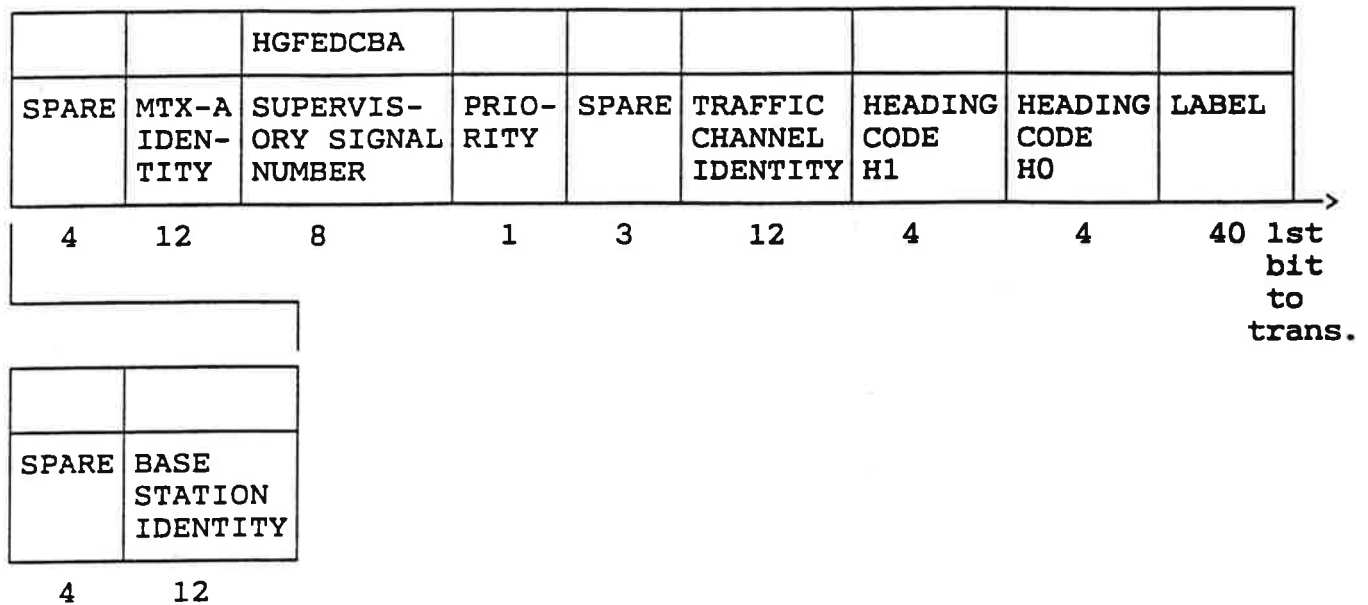

Figure 4.31. Signal Strength Measurement Order Message.

The following codes are used in the fields of the Signal Strength Measurement Order Message:

- a) Label: See paragraph 2.1.2.
- b) Heading code H0 is coded 1111.
- c) Heading code H1 is coded 0001.
- d) Traffic Channel identity (NA NB NC)

A 12 bit binary representation of the Traffic Channel Identity of the Traffic Channel the MS is currently using.

- e) Spare

NT/HANDOVER USER PART ADDENDUM TO MOBILE USER PART SPECIFICATION FOR NMT-900	Date: 1992-12-21	Edition: 7	Page: 56
--	---------------------	---------------	-------------

f) Priority

Bit A  
 0 Normal priority  
 1 Low priority

g) Supervisory Signal Number

Bit HGFEDCBA  
 00000000 No supervisory signal number present  
 00000001 Ass #1  
 00000010 Ass #2  
 00000011 Ass #3  
 00000100 Ass #4  
 00000101  
 through Spare values  
 01111111  
 10000000 Dss #0  
 10000001 Dss #1  
 . . .  
 10001000 Dss #8  
 . . .  
 10101001 Dss #41  
 . . .  
 11111111 Dss #127

h) MTX-A identity (Z'X<sub>1</sub>'X<sub>2</sub>').

Coding of this information as in paragraph 4.3.1.j.

i) Spare.

j) Base Station Identity (B<sub>1</sub> B<sub>2</sub> B<sub>3</sub>)

The identity of the BS currently serving the MS.

Coding of this information as in paragraph 4.3.1.j.

k) Spare



NT/HANDOVER USER PART ADDENDUM TO MOBILE USER PART SPECIFICATION FOR NMT-900	Date: 1992-12-21	Edition: 7	Page: 57
--	---------------------	---------------	-------------

#### 4.8.2 Signal Strength Measurement Acknowledge Message (SMA)

The basic format of the SMA is shown in figure 4.32.

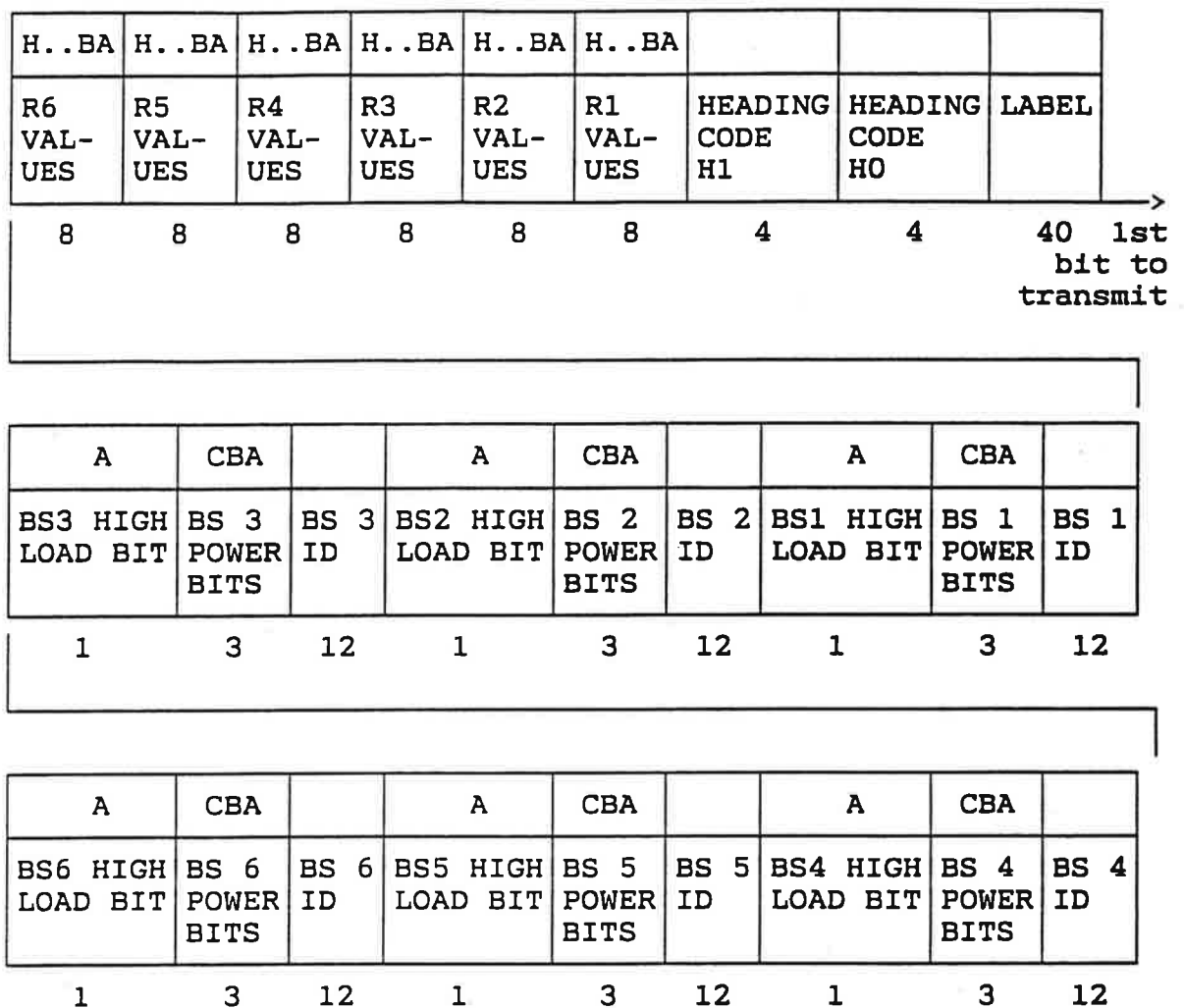

Figure 4.32. Signal Strength Measurement Acknowledge Message.

NT/HANDOVER USER PART ADDENDUM TO MOBILE USER PART SPECIFICATION FOR NMT-900	Date: 1992-12-21	Edition: 7	Page: 58
--	---------------------	---------------	-------------

The following codes are used in the fields of the Signal Strength Measurement Acknowledge Message:

- a) Label: See paragraph 2.1.2.
- b) Heading code H0 is coded 1111.
- c) Heading code H1 is coded 0010.
- d) R1 value

Bit	FEDCBA	R1 value
	000000	0
	000001	1
	000010	2
	000011	3
	000100	4
	000101	5
	000110	6
	.	
	.	
	.	
	111110	62
	111111	63

Bit G: More Measurement Values Indicator

- 0: More measurement values follows this one
- 1: This is the last measurement value

The measurement values available shall be coded sequentially into the R1 .. R6 values. This bit set to 1 indicates that none of the subsequent values contains valid data.

Bit H: Measurement indicator

- 0: valid measurement
- 1: measurement not correct.

- e) R2 value  
See paragraph 4.8.2.d.

- f) R3 value  
See paragraph 4.8.2.d.

NT/HANDOVER USER PART ADDENDUM TO MOBILE USER PART SPECIFICATION FOR NMT-900	Date: 1992-12-21	Edition: 7	Page: 59
--	---------------------	---------------	-------------

g) R4 value  
See paragraph 4.8.2.d.

h) R5 value  
See paragraph 4.8.2.d.

i) R6 value  
See paragraph 4.8.2.d.

j) Base station 1 identity ( $B_1 B_2 B_3$ )  
Coding of this information as in paragraph 4.3.1.j.

k) Base station 1 power bits.

These bits indicates the maximum MS output power allowed when served by this BS. The coding of these bits have the following meaning:

Bit	CBA
	000 Low power
	001 Medium power
	010 High power, umbrella BS
	011 High power
	100 Low power, imbrella BS
	101 Medium power; umbrella BS
	110 Spare
	111 Spare

l) Base station 1 high load bit.

This bit is used to indicate whether the BS is a high load BS or not

Bit	A
	0 Not high load BS
	1 high load BS

m) Base station 2 identity ( $B_1 B_2 B_3$ )  
Coding of this information as in paragraph 4.3.1.j.

n) Base station 2 power bits.  
See paragraph 4.8.2.k.

o) Base station 2 high load bit.  
See paragraph 4.8.2.l.

p) Base station 3 identity ( $B_1 B_2 B_3$ )

NT/HANDOVER USER PART ADDENDUM TO MOBILE USER PART SPECIFICATION FOR NMT-900	Date: 1992-12-21	Edition: 7	Page: 60
--	---------------------	---------------	-------------

Coding of this information as in paragraph 4.3.1.j.

- q) Base station 3 power bits.  
See paragraph 4.8.2.k.
- r) Base station 3 high load bit.  
See paragraph 4.8.2.1.
- s) Base station 4 identity ( $B_1 B_2 B_3$ )

Coding of this information as in paragraph 4.3.1.j.

- t) Base station 4 power bits.  
See paragraph 4.8.2.k.
- u) Base station 4 high load bit.  
See paragraph 4.8.2.1.
- v) Base station 5 identity ( $B_1 B_2 B_3$ )

Coding of this information as in paragraph 4.3.1.j.

- w) Base station 5 power bits.  
See paragraph 4.8.2.k.
- x) Base station 5 high load bit.  
See paragraph 4.8.2.1.
- y) Base station 6 identity ( $B_1 B_2 B_3$ )

Coding of this information as in paragraph 4.3.1.j.

- z) Base station 6 power bits.  
See paragraph 4.8.2.k.
- aa) Base station 6 high load bit.  
See paragraph 4.8.2.1.

#### 4.8.3 Signal Strength Measurement Rejected Message (SMR)

The basic format of the SMR is shown in figure 4.33.

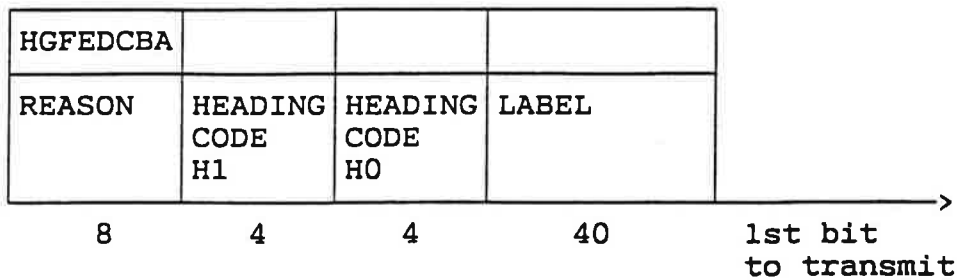

Figure 4.33. Signal Strength Measurement Rejected Message.

The following codes are used in the fields of the Signal Strength Measurement Rejected Message:

- a) Label: See paragraph 2.1.2.
- b) Heading code H0 is coded 1111.
- c) Heading code H1 is coded 0011.
- d) Reason

DCBA  
0000 Unknown base station identity  
0001 No neighbouring base station specified  
0010 No measurements available  
0011 Internal congestion  
0100 Miscellaneous

(The remaining codes are spare)

Bits HGFE: Spare

NT/HANDOVER USER PART ADDENDUM TO MOBILE USER PART SPECIFICATION FOR NMT-900	Date: 1992-12-21	Edition: 7	Page: 62
--	---------------------	---------------	-------------

#### 4.8.4 Handover Offer Message (HOM)

The basic format of the HOM is shown in figure 4.34.

Note: The use of this message is a national matter related to the use of the SLUX function.

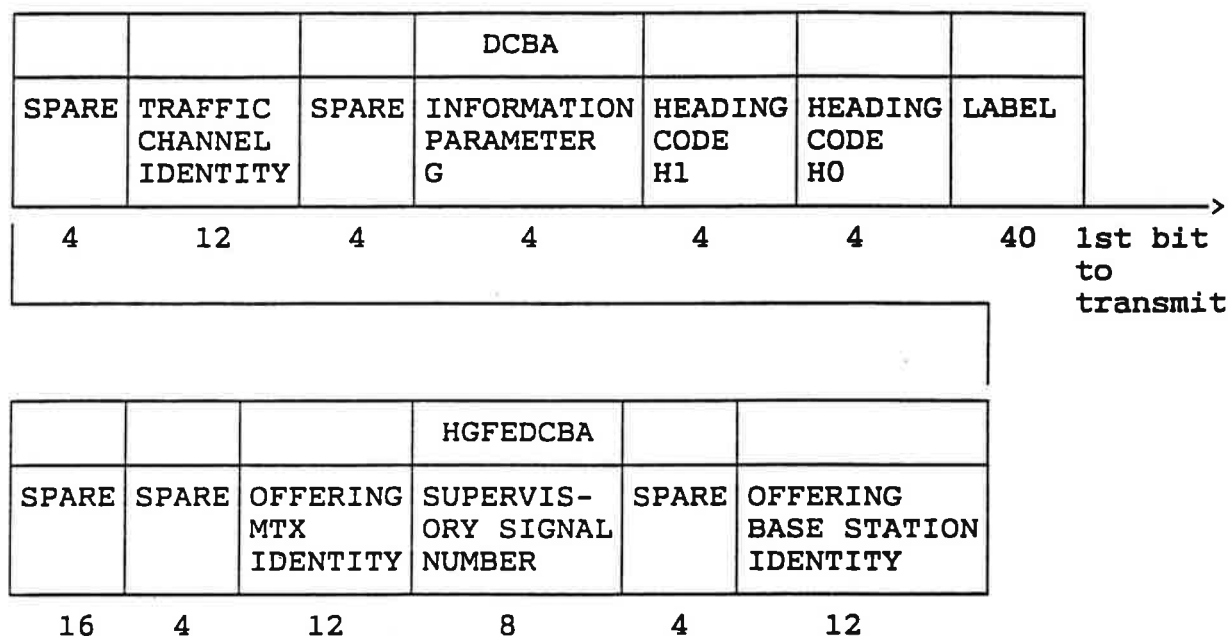

Figure 4.34. Handover Offer Message

The following codes are used in the fields of the Handover Offer Message:

- a) Label: See paragraph 2.1.2.
- b) Heading code H0 is coded 1111.
- c) Heading code H1 is coded 0100.
- d) Information Parameter G  
This parameter determines the action which shall be taken by the MTX receiving the HOM.

NT/HANDOVER USER PART ADDENDUM TO MOBILE USER PART SPECIFICATION FOR NMT-900	Date: 1992-12-21	Edition: 7	Page: 63
--	---------------------	---------------	-------------

Bit DCBA  
0000 G(0)  
0001 G(1)  
0010 G(2)  
0100 G(4)  
1000 G(8)

(The remaining codes are spare).

e) Spare.

f) Traffic channel identity ( $N_a N_b N_c$ )

A 12 bit binary representation of the identity of the traffic channel that is indicated to have a high signal strength monitored by the offering BS. This information is coded as in paragraph 4.3.3.d.

g) Spare.

h) Offering base station identity ( $B_1 B_2 B_3$ )

Identity of offering base station i.e. the identity of the base station which initiates that HOM is sent from the offering MTX. This information is coded as in paragraph 4.3.1.j.

i) Spare.

j) Supervisory Signal Number

Number of the supervisory signal of the call detected by the offering base station. This information is coded as in paragraph 4.8.1.f.

k) Offering MTX identity ( $Z'X_1'X_2'$ )

Identity of the MTX to which the offering base station belongs. This information is coded as in paragraph 4.3.1.j.

l) Spare.

m) Spare. The 12 most significant bits are reserved for future transfer of the serving base station identity.

NT/HANDOVER USER PART ADDENDUM TO MOBILE USER PART SPECIFICATION FOR NMT-900	Date: 1992-12-21	Edition: 7	Page: 64
--	---------------------	---------------	-------------

## 5 HANDOVER PROCEDURES

Handover is applicable only between national MTXs.

In the next paragraphs the following abbreviations will be used:

- MTX-1 handles the call originally (Controlling MTX).
- MTX-2 will handle the call after a Basic Handover procedure has been performed (target/serving MTX).
- MTX-3 will handle the call after a Subsequent Handover procedure has been performed and the new MTX is not the MTX-1.
- MTX-A handles the call at the moment (the serving MTX).
- MTX-B,C,D... are possible MTXs to which the MTX-A will initiate the handover procedure. In the following examples, MTX-B is the MTX chosen (target MTX).
- MTX-OF is the MTX offering a handover to neighbouring MTX's including the serving MTX i.e. MTX-A, MTX-B, MTX-C, ... . MTX-OF may be contained in the list of neighbouring MTX's in which case MTX-OF will not offer a handover to MTX-OF itself.

To avoid charging problems and in order to handle the subscriber services in a proper way, the MTX-1 must have the call-control during the entire call.

If, after an external handover has been performed, the MS is not able to find the old calling channel after the call has been completed, it will initiate the Location Updating procedure in the normal way.

### 5.1 Measurement procedure

The procedure starts when the MTX-A recognizes that the signal strength of the mobile station has fallen below a certain limit and that some of the neighbouring base stations are controlled by other MTXs (MTX-B,C,D...).

The MTX-A then sends a Signal Strength Measurement Order Message (SMO) to the other MTXs. The choice of other MTXs depends on national and geographical matters. Only the procedure between the MTX-A and the MTX-B is shown. The procedures between the MTX-A and MTX-C,D... will be similar.

When sending SMO a timer T121 is started.



NT/HANDOVER USER PART ADDENDUM TO MOBILE USER PART SPECIFICATION FOR NMT-900	Date:  1992-12-21	Edition:  7	Page:  65
--	-------------------------	-------------------	-----------------

The SMO will specify the base station where the mobile station is located, the MTX to which this base station is connected, the radio channel used and the supervisory tone.

The MTX-B now performs the signal strength measurement on the specified radio channel on all the neighbouring base stations according to the national arrangement. The available results and the maximum output power levels for the respective base stations are then transferred to the MTX-A in a Signal Strength Measurement Acknowledge Message (SMA). The SMA is capable of transferring the results from maximum six base stations.

For the MTX-B, one of the handover-procedures in paragraph 5.2 or 5.3 may be initiated. For MTX-C,D... the signalling procedure terminates.

The priority in SMO is set by the MTX which orders the measurement. Different procedures is given different priorities e.g. a SMO measurement initiated by signal strength supervision must have low priority and a SMO initiated by transmission quality alarm must have normal priority.

If the measurement load is too high in the receiving MTX, the SMO message may be answered with an SMR (reason-internal congestion).

If the received base station identity does not exist, if there is no neighbouring base station to the one specified or if MTX-B is not able to provide any measurements data, the MTX-B sends the Signal Strength Measurement Rejected Message (SMR) with the reason for the rejection. MTX-A may then choose another base station or terminate the procedure.

If timer T121 expires before SMA/SMR is received, MTX-A may use the results received from other MTXs, terminate the procedure or initiate a new procedure by sending SMO.

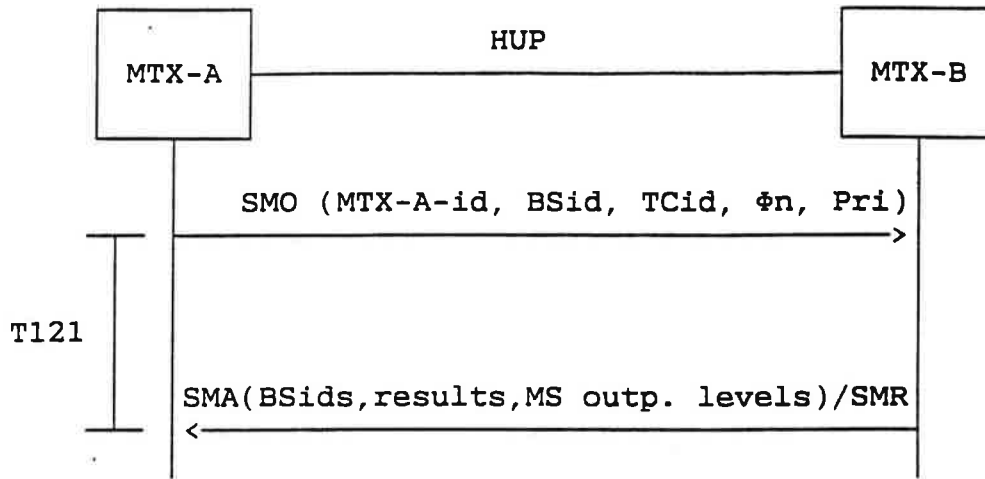

Figure 5.1. Handover, Measurement procedure.

NT/HANDOVER USER PART ADDENDUM TO MOBILE USER PART SPECIFICATION FOR NMT-900	Date: 1992-12-21	Edition: 7	Page: 67
--	---------------------	---------------	-------------

## 5.2 Basic Handover procedure

If, in the Measurement procedure, the MTX-A-id is identical to the MTX-1, the Basic Handover procedure may follow the Measurement procedure described in paragraph 5.1.

The procedure is started by selecting and seizing an appropriate circuit. MTX-1 now sends Traffic Channel Request (TCR) including the Mobile Station Identity, the identity of the selected base station, the MS categories and the indicators for Queuing, Traffic direction and Immediate Call Diversion. When sending TCR, timer T101 is started.

If the MTX-2 (target MTX) is capable of handling the request (e.g. free radio channel is available) it reserves a traffic channel (TC) and sends Traffic Channel Acknowledge Message (TCA) including the identity of the new traffic channel and the maximum MS output level in the new cell. The TCA is sent at the same time as identity request of the NMT 900 signalling system in a new traffic channel (TC) is sent, (See NMT Doc. 900-1). Timeout for sending identity request is prolonged from the ordinary switching call in progress (within the same exchange) value 1107 ms to 3321 ms.

If there is no free traffic channel available, the MTX-2 queues the call in accordance with the "queuing indicator" field in the TCR<sup>2</sup>. If queuing is allowed, the MTX-2 holds the TCR in a queue for a predetermined time, T102. If no traffic channel becomes available during this queuing, the MTX-2 sends a Traffic Channel Not Available Message (TCN) and starts a timer T105. When receiving TCN, the MTX-1 sends Clear Forward (CLF) to MTX-2, and may then repeat the procedure for the second best measurement result or terminate the procedure.

After the MTX-1 has received the Traffic Channel Acknowledgement Message from MTX-2, it starts the switching procedure.

When the MTX-1 receives the TCA it orders the MS to the new TC and starts a timer T103. The MS moves to the new TC and, if it receives identity request, it responds with its identity. If the MS does not receive identity request in the new TC, it returns to the previous TC.

---

<sup>2</sup> If the queuing indicator is set to "queuing allowed", the logic in the MTX-1 must see to it that the autonomous repetition of handover attempts is not performed until TCA/TCN is received or T101 expires.

NT/HANDOVER USER PART ADDENDUM TO MOBILE USER PART SPECIFICATION FOR NMT-900	Date: 1992-12-21	Edition: 7	Page: 68
--	---------------------	---------------	-------------

When the MTX-2 recognizes that the MS has responded on the new TC (MTX receives MS identity on the new TC), it sends Switching Successful Indication Message (SSI) to the MTX-1. When the MTX-1 receives SSI, it performs reselection and releases the old TC. The call is now switched to the new TC and handled by MTX-2.

If the timer for identity request frame (=3321 ms) expires, the MTX-2 sends the Switching Not Successful Indication Message (SSN) to the MTX-1 and releases the TC. When sending SSN a timer T106 is started. The call is retained on the previous TC on the MTX-1. When receiving SSN, the MTX-1 initiates release of the circuits (by sending CLF) and may start a new procedure by sending SMO.

At any stage of the Handover procedure MTX-1 may terminate the procedure by sending Clear Forward (CLF) to MTX-2. The CLF will be sent if the MS clears the call before the Handover procedure has been completed, if the connection to the MS is interrupted, if the TCA/TCN is not received before T101 expires, if SSI/SSN is not received before T103 expires, or if the connection between MTX-1 and MTX-2 cannot be established.

If the mobile subscriber served by MTX-2 goes on hook, MTX-2 sends the Subscriber Termination Message (STE) to MTX-1. As a response MTX-1 sends CLF.

The detailed description of time supervision and procedures for call handling is given in paragraphs 5.7 and 5.8.

The procedures are described in the following figures.

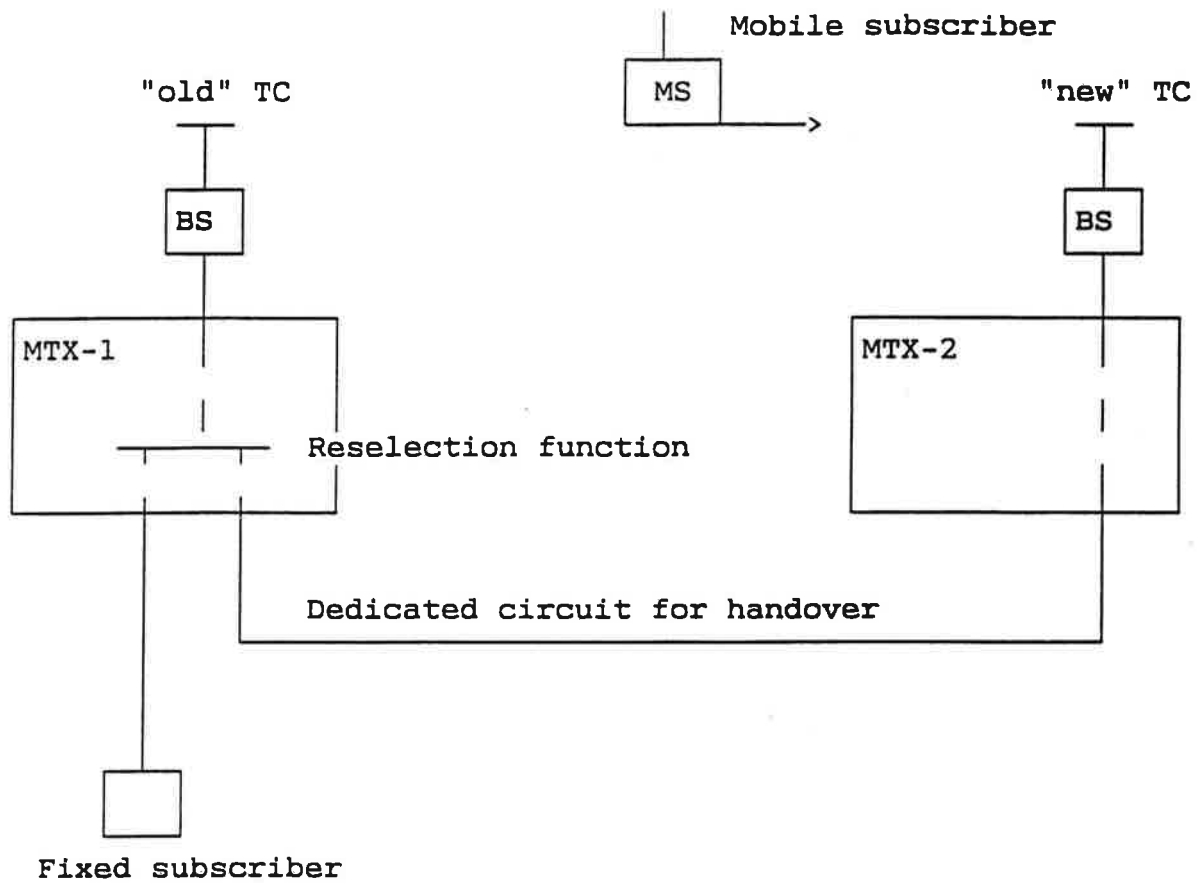

Figure 5.2 Basic Handover of call.

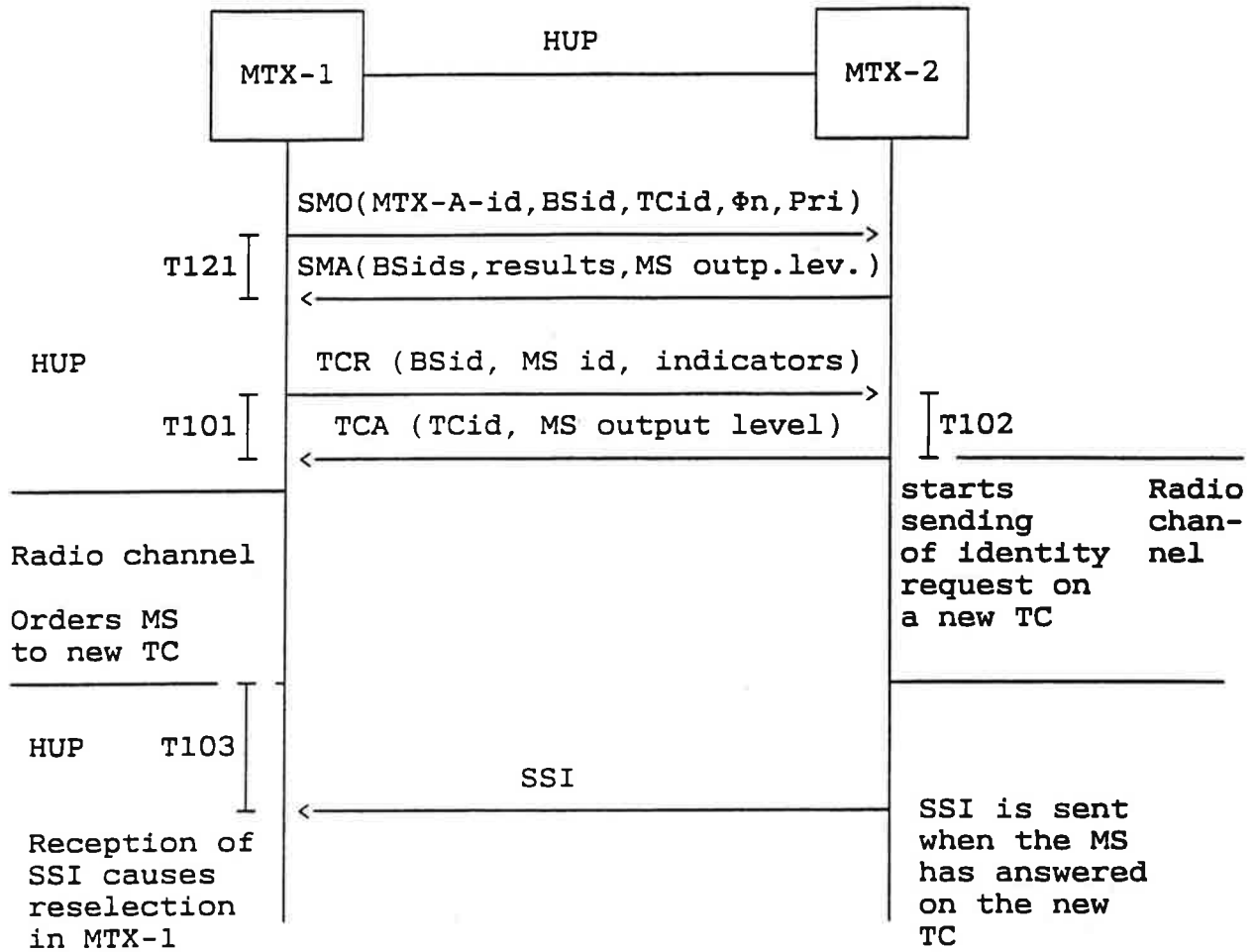

Figure 5.3 Basic Handover, successful call.

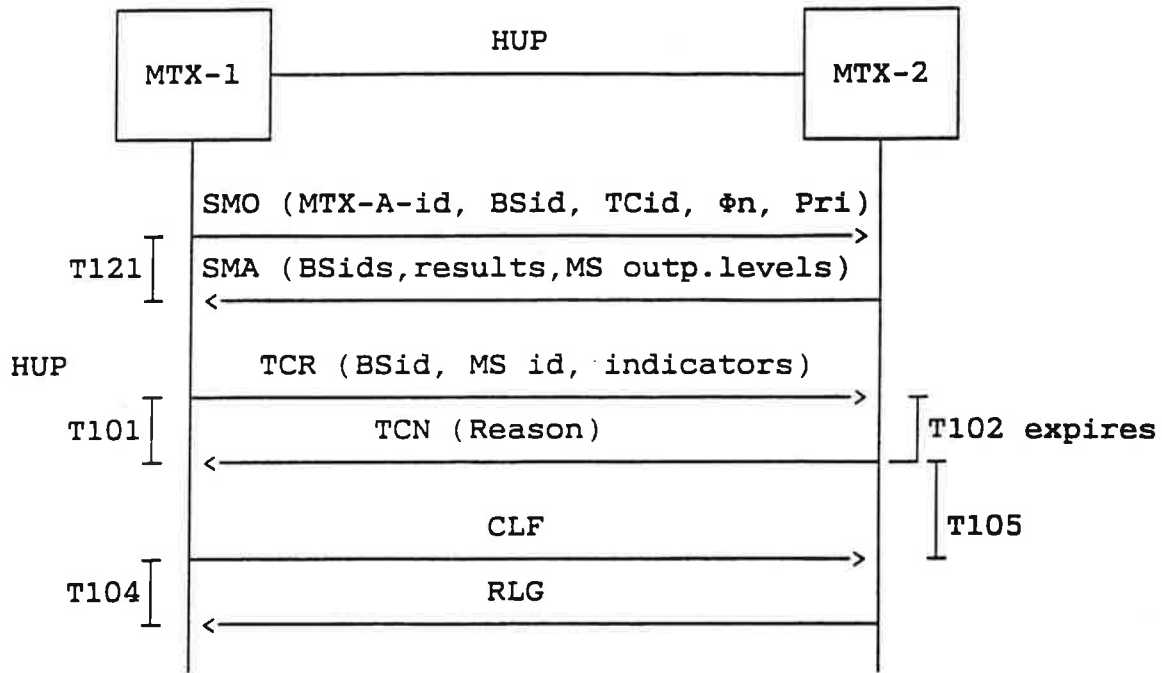

Figure 5.4 Basic Handover; no free traffic channel in new MTX-2 available.

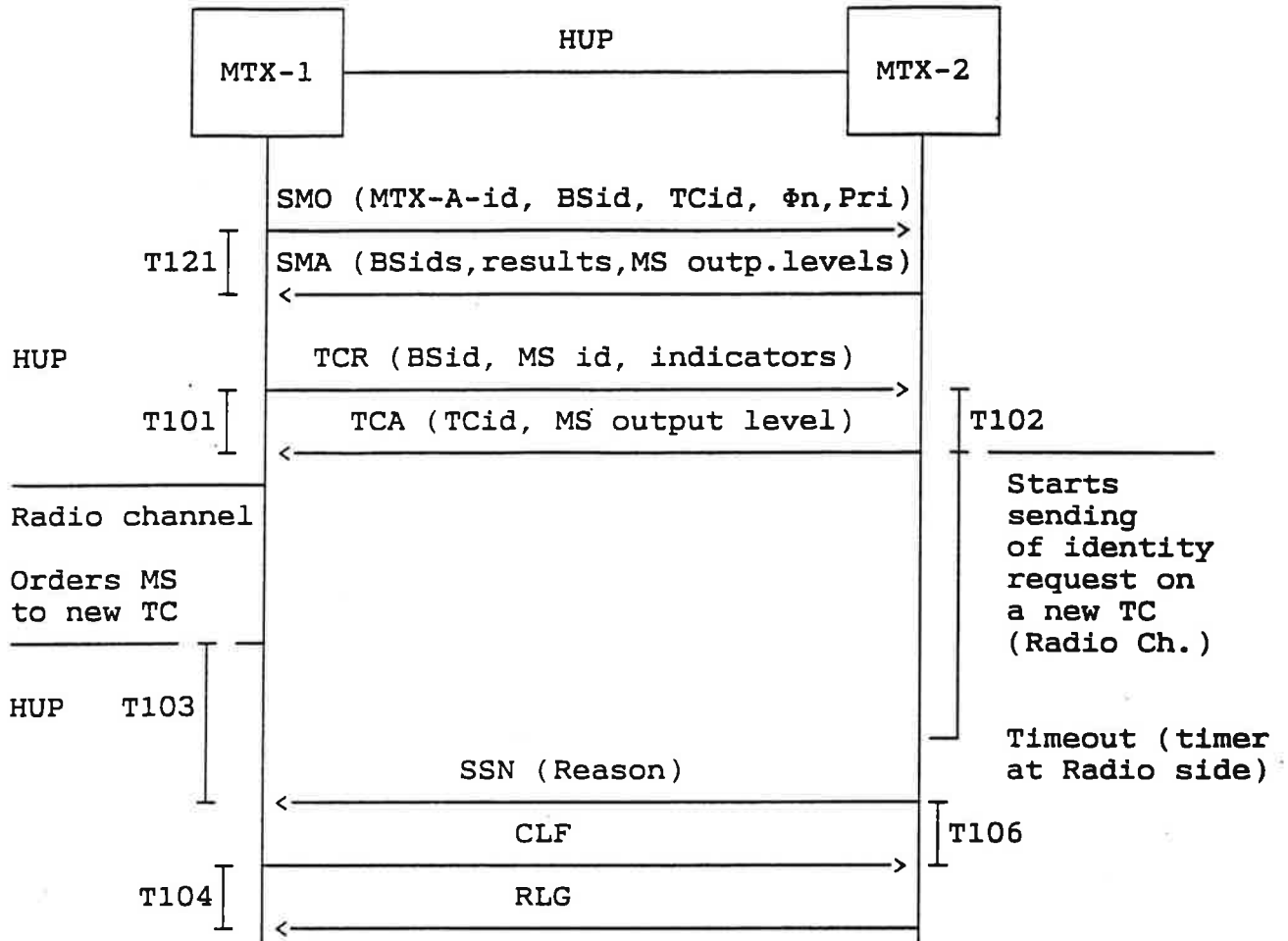

Figure 5.5 Basic Handover; timer for sending identity request on new TC expires.



NT/HANDOVER USER PART ADDENDUM TO MOBILE USER PART SPECIFICATION FOR NMT-900	Date: 1992-12-21	Edition: 7	Page: 73
--	---------------------	---------------	-------------

### 5.3 Subsequent Handover procedure

When a mobile station, after the call has been handed over from MTX-1 to MTX-2, leaves the area of MTX-2 during the same call, subsequent handover is necessary in order to continue the connection.

The following cases are identified:

- i) the MS moves back to the area of MTX-1;
- ii) the MS moves into the area of a third MTX (MTX-3).

In all cases the call is redirected in MTX-1. The connection between MTX-1 and MTX-2 shall be released when a successful handover has been performed.

When the MTX-2 recognizes that the signal strength of the mobile station has fallen below a certain limit, and that some of the neighbouring base stations are controlled by other MTXs, it starts the Measurement Procedure described in paragraph 5.1.

After the Measurement Procedure is terminated, the MTX-2 sends Subsequent Handover Request Message (SHM) to the MTX-1 and starts a timer T111. The identity of the selected base station, the queuing indicator and the identity of the new MTX (MTX-B) are included in the message.<sup>3</sup>

If the MTX-B identity in the SHM is identical to MTX-1's identity, the procedure in paragraph 5.3.1 is started. Otherwise, if the MTX-B identity is not the MTX-1's identity, the procedure in paragraph 5.3.2 is started.

#### 5.3.1 Subsequent handover from MTX-2 to MTX-1

If the MTX-1 is capable of handling the request (e.g. free radio channel is available), it reserves a traffic channel and starts sending an identity request in the same way as described in paragraph 5.2. At the same time it sends Subsequent Handover Acknowledge Message (SHA) including the identity of the new traffic channel.

If no free traffic channel is available, the MTX-1 queues the call in accordance with the "queuing indicator" field in the SHM. If queuing is allowed, the MTX-1 holds the SHM in a queue for a predetermined time, T109. If no traffic channel becomes available during this queuing, the MTX-1 sends an SHR with the reason field set to "no free traffic channel". The MTX-2 may then repeat the procedure for the second best measurement

---

<sup>3</sup> If the queuing indicator is set to "queuing allowed", the logic in the MTX-2 must see to it that the autonomous repetition of handover attempts is not performed until SHA/SHR is received or T111 expires.

NT/HANDOVER USER PART ADDENDUM TO MOBILE USER PART SPECIFICATION FOR NMT-900	Date: 1992-12-21	Edition: 7	Page: 74
--	---------------------	---------------	-------------

result, start new measurement or terminate the procedure.

When the MTX-2 receives the SHA, it orders the mobile station to the new traffic channel and starts a timer T110. The mobile station moves to the new traffic channel and, if it receives identity request, it responds with its identity. MTX-1 then performs reselection and sends CLF to the MTX-2.

If the mobile station does not receive identity request on the new traffic channel, it returns to the previous traffic channel.

If the timer for identity request frame (=3321 ms) expires, the MTX-1 sends the Switching Not Successful Indication Message (SSN) to the MTX-2, and releases the TC. The call is retained on the previous TC on the MTX-2. When receiving SSN, MTX-2 may start a new procedure by sending SMO.

At any stage of the Handover procedure MTX-2 may terminate the procedure by sending Subscriber Termination (STE) or Call Failure (CFL) to MTX-1. The STE will be sent if the MS clears the call before the Handover procedure has been completed. The CFL will be sent if the connection to the MS is interrupted or if CLF/SSN is not received before T110 expires.

When receiving CFL or STE, MTX-1 starts the normal release procedure by sending CLF.

The detailed description of time supervision and procedures for call handling is given in paragraphs 5.7 and 5.8.

The procedures are described in the following figures.

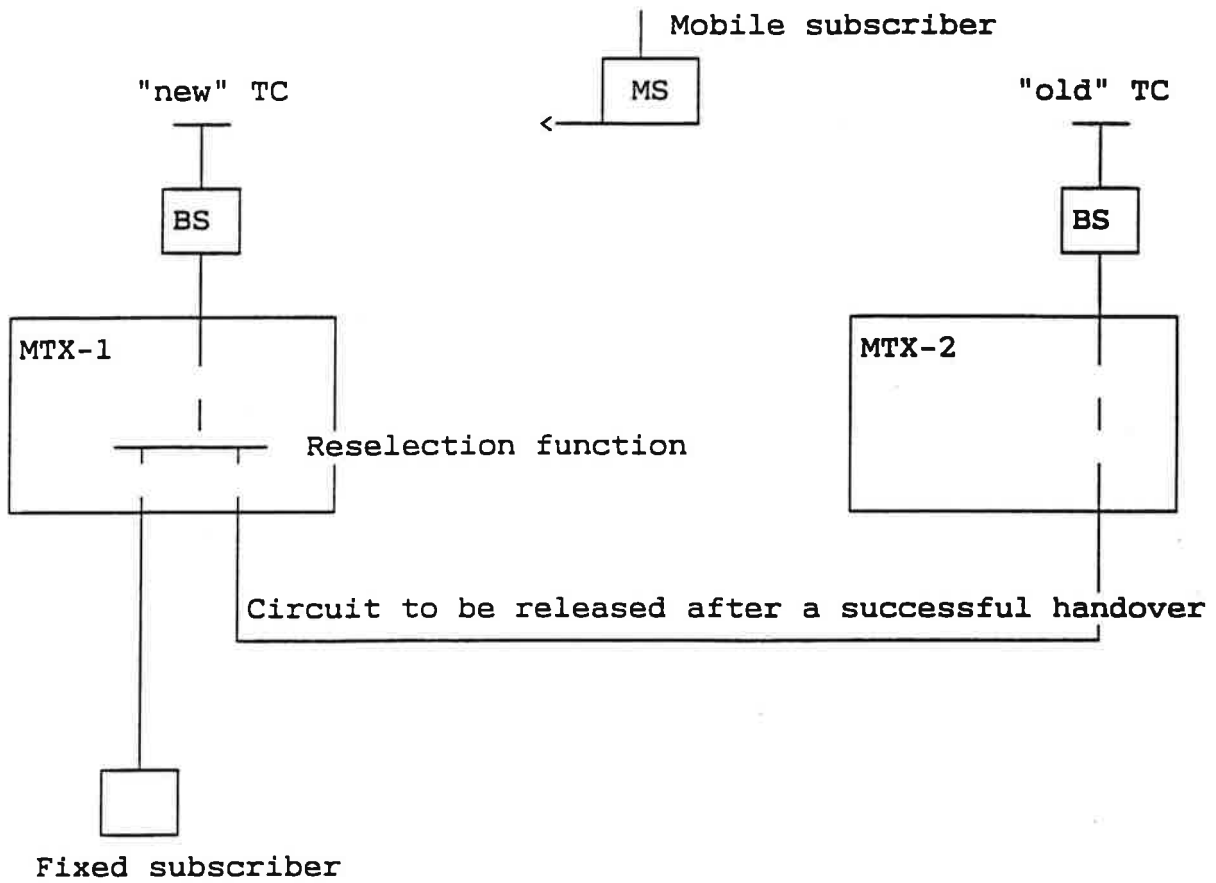

Figure 5.6 Subsequent Handover from MTX-2 to MTX-1.

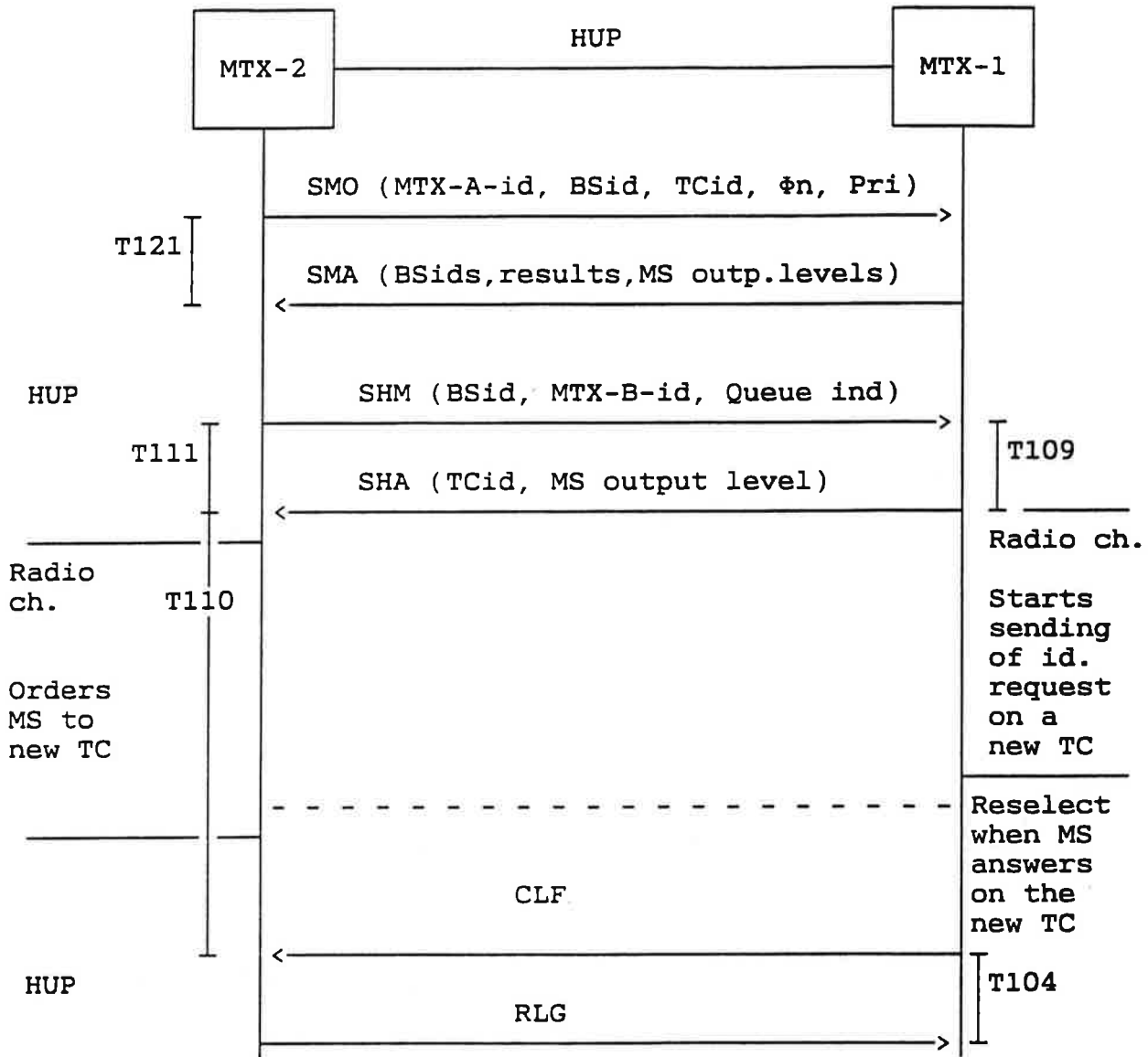

Figure 5.7 Subsequent handover from MTX-2 (MTX-A) to MTX-1, successful handover.

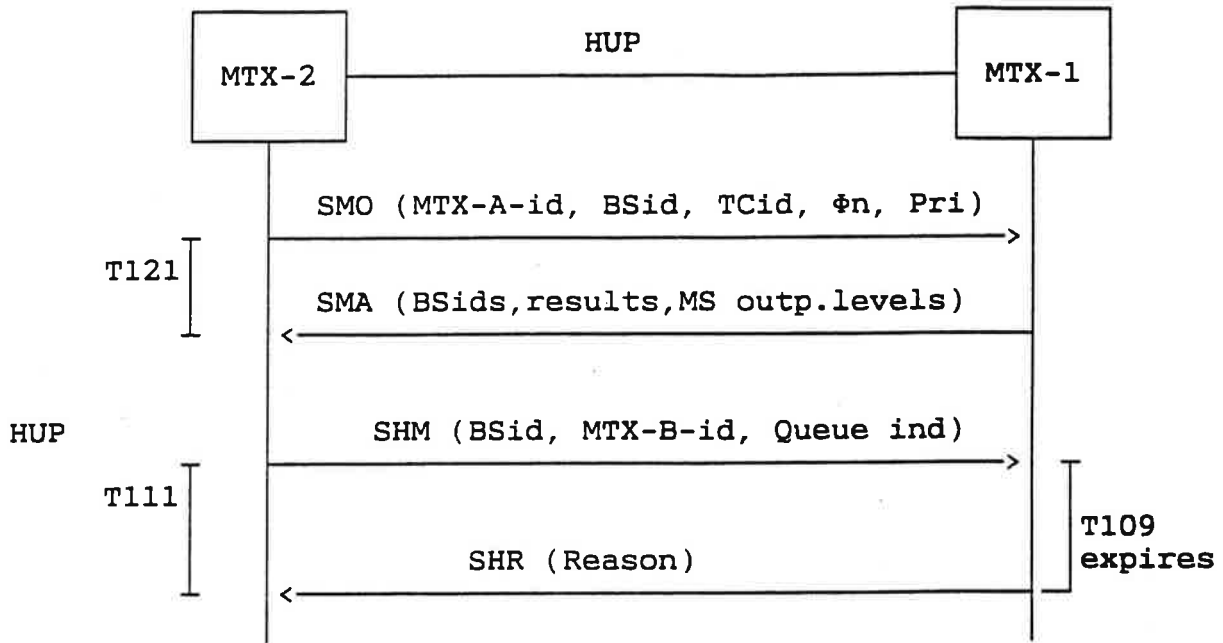

Figure 5.8 Subsequent handover from MTX-2 to MTX-1; no free traffic channel in MTX-1 available.

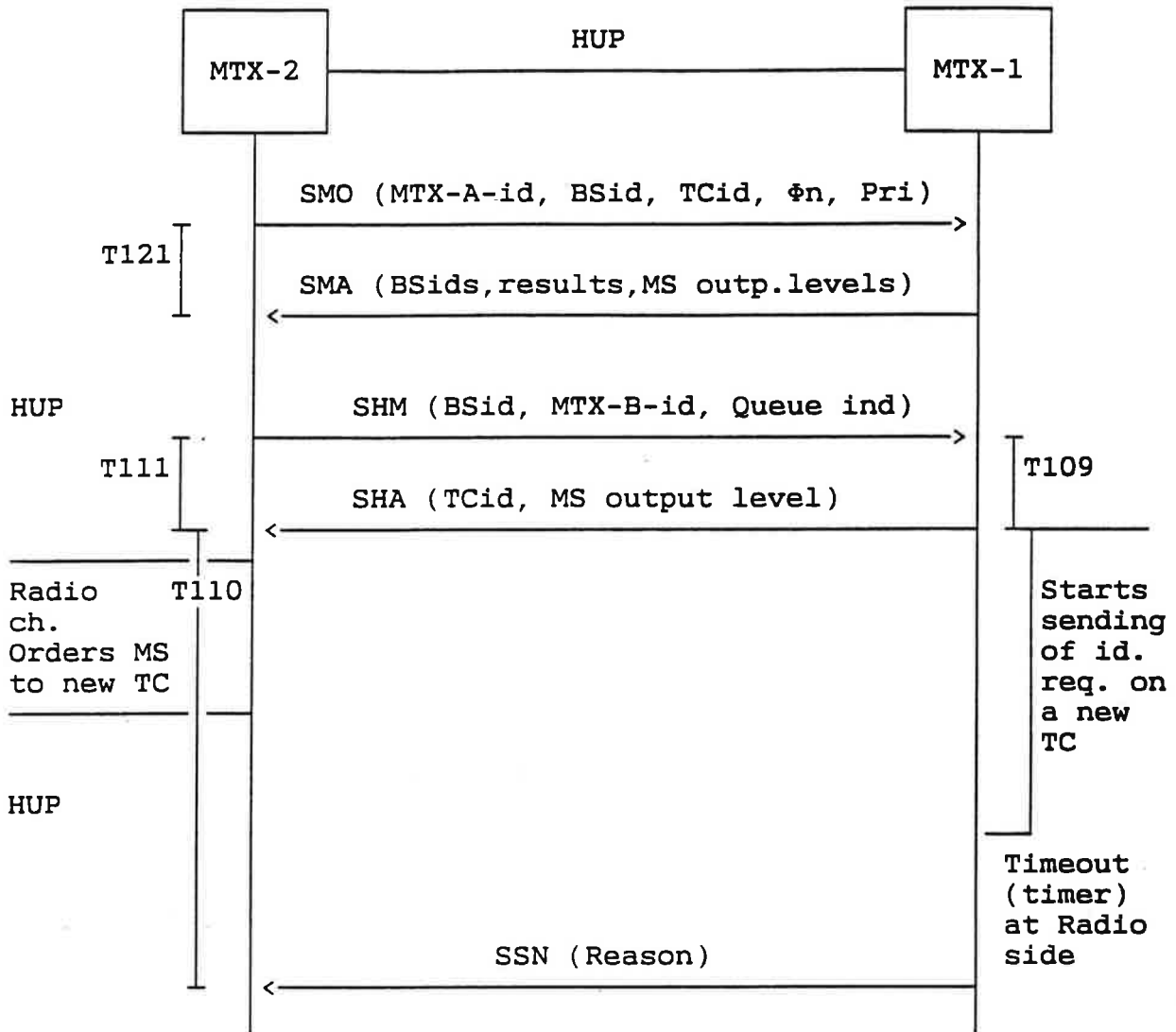

Figure 5.9. Subsequent handover from MTX-2 to MTX-1; timer for sending identity request on new TC expires.

NT/HANDOVER USER PART ADDENDUM TO MOBILE USER PART SPECIFICATION FOR NMT-900	Date: 1992-12-21	Edition: 7	Page: 79
--	---------------------	---------------	-------------

### 5.3.2 Subsequent handover from MTX-2 to MTX-3

The MTX-B identity in the SHM is now set to MTX-3, and the MTX-1 therefore seizes an appropriate circuit and sends Traffic Channel Request (TCR) to the MTX-3 including the Mobile Station Identity, the identity of the selected base station, the MS categories and the indicators for Queuing, Traffic direction and Immediate Call Diversion. The procedure between MTX-1 and MTX-3 will now follow the Basic Handover procedure described in paragraph 5.2.

If the MTX-3 is capable of handling the request (e.g. free radio channel is available) it reserves a traffic channel (TC) and sends Traffic Channel Acknowledge Message (TCA) including the identity of the new traffic channel and the MS output level in the new cell. At the same time it start sending the Identity Request in the new traffic channel.

If there is no free traffic channel available, the MTX-3 queues the call in accordance with the "queuing indicator" field in the TCR (received from MTX-2 in the SHM). If queuing is allowed, the MTX-3 holds the TCR in a queue for a predetermined time, T102. If no traffic channel becomes available during this queuing, the MTX-3 sends a Traffic Channel Not Available Message (TCN) and starts a timer T105. The MTX-1 then sends an SHR with the reason field set to "no free TC" to the MTX-2 and sends CLF to MTX-3. The MTX-2 may then repeat the procedure for the second best measurement result, start a new measurement or terminate the procedure.

When the MTX-1 receives the TCA it sends SHA, including the identity of the new TC and the maximum MS output level in the new cell, to MTX-2. When SHA is sent a timer T112 is started. When the MTX-2 receives SHA it orders the mobile station to the new TC.

When the MTX-3 recognizes that the mobile station has responded on the new traffic channel (MTX receives mobile station identity on the new traffic channel), the MTX-3 sends Switching Successful Indication Message (SSI) to the MTX-1. When the MTX-1 receives SSI, it performs reselection and initiates release of the "old" circuits towards MTX-2 by sending CLF.

If the timer for identity request frame (=3321 ms) expires, the MTX-3 sends the Switching Not Successful Indication Message (SSN) to MTX-1, starts a timer T106, and releases the traffic channel. The call is retained on the previous traffic channel on MTX-2. When receiving SSN, MTX-1 sends SSN towards MTX-2 and initiates release of the circuits towards MTX-3 by sending CLF to MTX-3. When receiving SSN, MTX-2 may start a new procedure by sending SMO.

If the timer T101 expires, supervising TCR-TCA/TCN, MTX-1 shall send CLF to MTX-3 and SHR to MTX-2 with the "reason" fields set.

When receiving SHR, MTX-2 may repeat the procedure for the second best

NT/HANDOVER USER PART ADDENDUM TO MOBILE USER PART SPECIFICATION FOR NMT-900	Date: 1992-12-21	Edition: 7	Page: 80
--	---------------------	---------------	-------------

measurement result, start a new measurement or terminate the procedure.

At any stage of the Handover procedure, MTX-2 may terminate the procedure by sending Subscriber Termination (STE) or Call Failure (CFL) to MTX-1. The STE will be sent if the MS has cleared the call. The CFL will be sent if the connection to the MS is interrupted or if CLF/SSN is not received before T110 expires.

If timer T112 expires before SSI/SSN is received, MTX-1 sends CLF to both MTX-2 and MTX-3.

When receiving CFL or STE, MTX-1 starts the normal release procedure by sending CLF.

The detailed description of time supervision and procedures for call handling is given in paragraphs 5.7 and 5.8.

After a successful handover has taken place, the MTX-3 is considered as an MTX-2 so that the Subsequent Handover procedures are applicable for any series of handover between MTXs.

The procedures are described in the following figures.



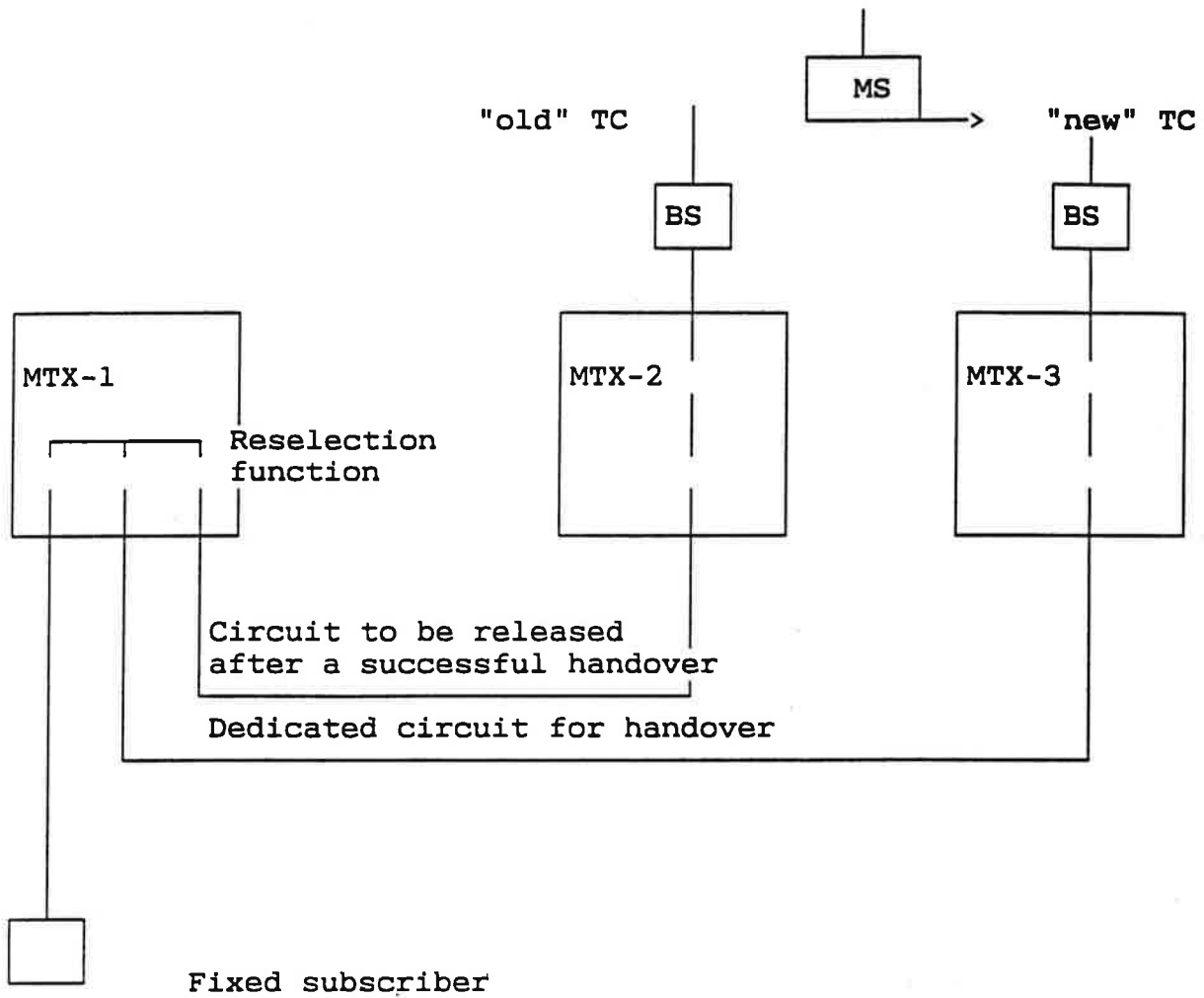

Figure 5.10 Subsequent Handover from MTX-2 to MTX-3.

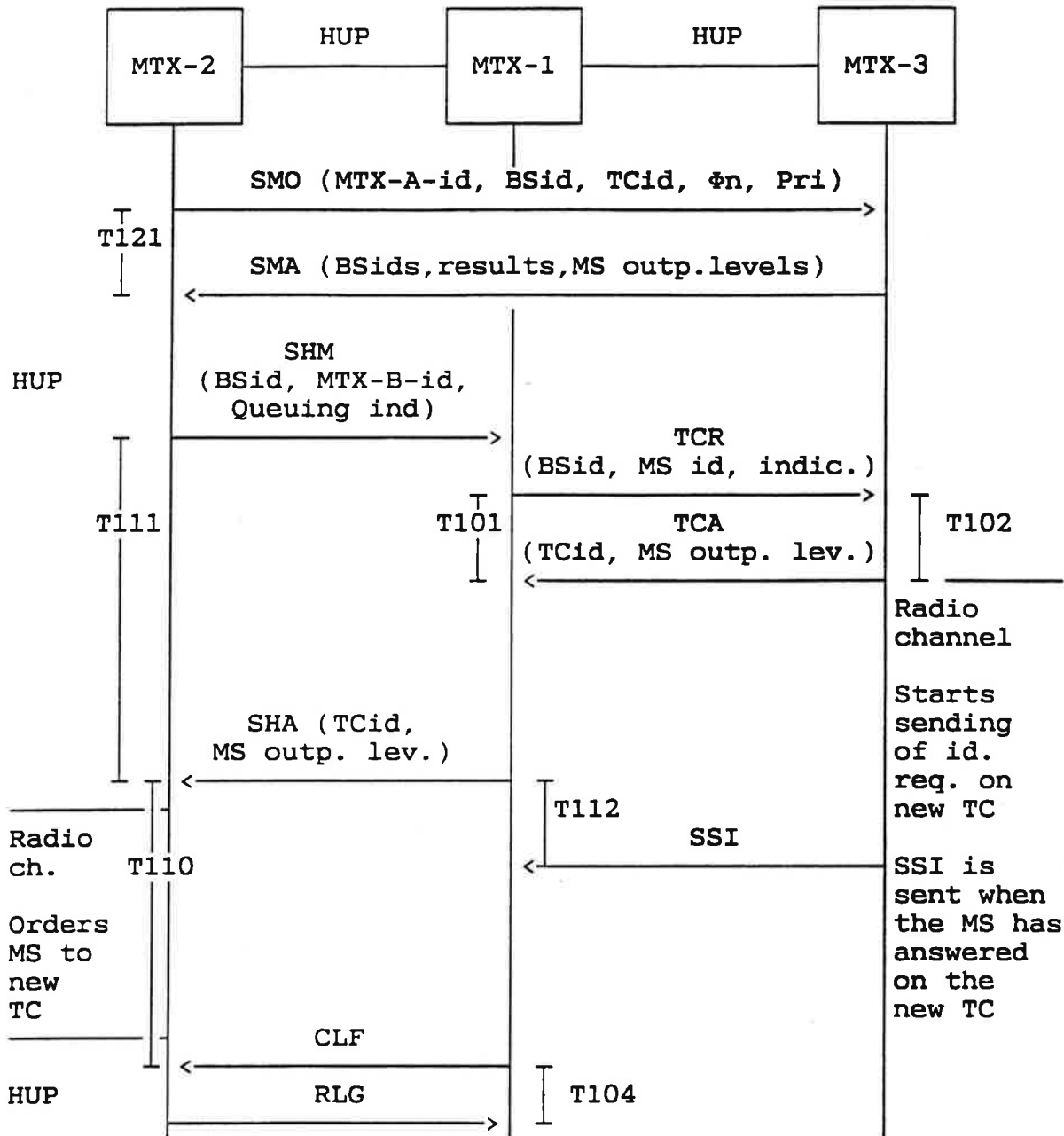

Figure 5.11 Subsequent Handover from MTX-2 to MTX-3, successful handover.

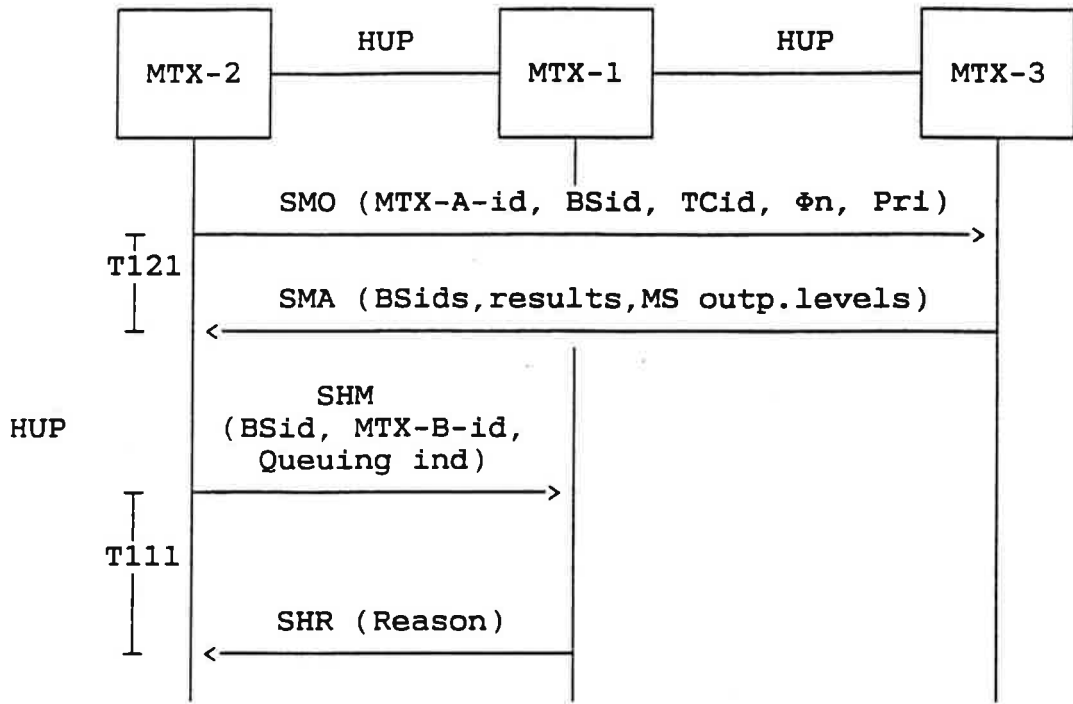

Figure 5.12 Subsequent Handover from MTX-2 to MTX-3, no free handover circuits between MTX-1 and MTX-3.

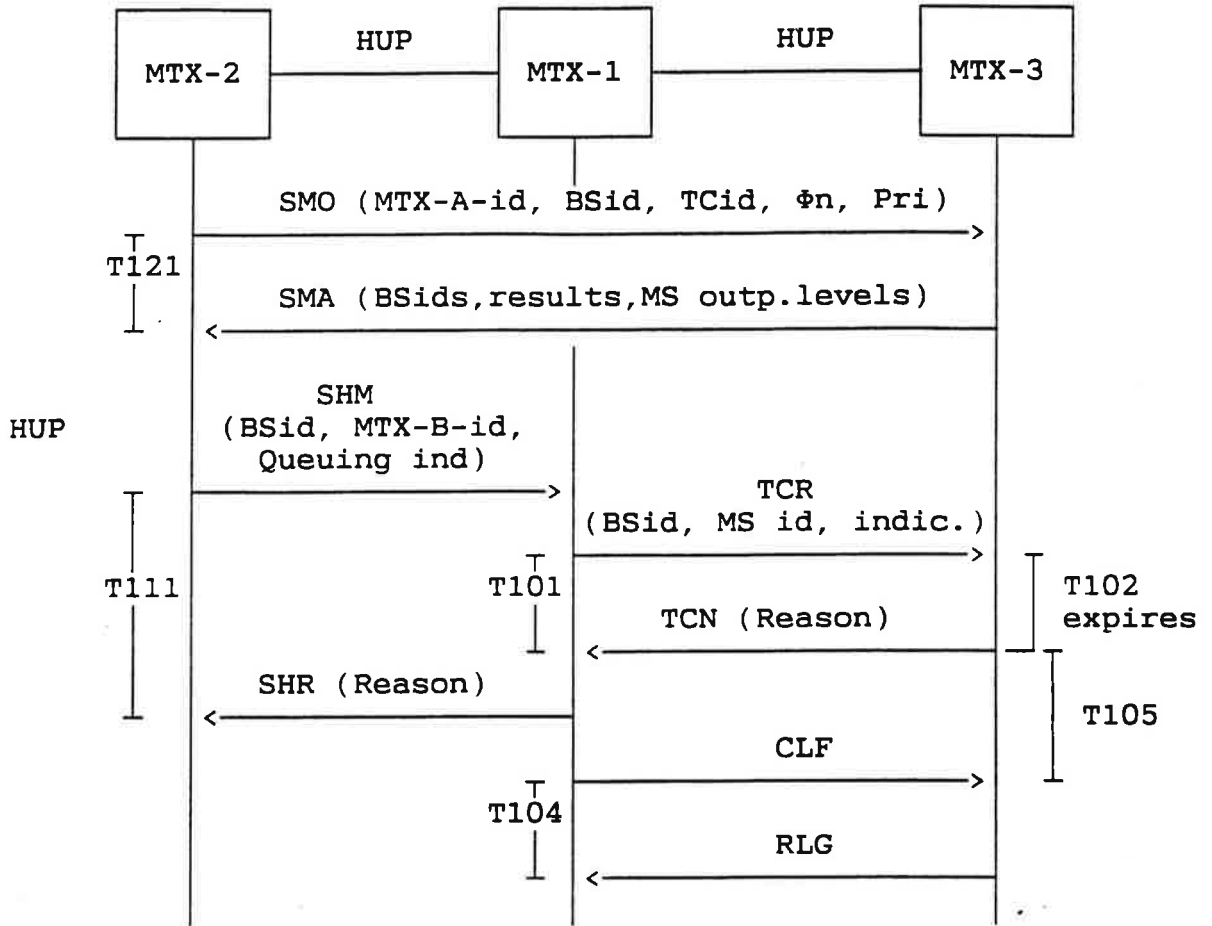

Figure 5.13 Subsequent Handover from MTX-2 to MTX-3; no free traffic channel in MTX-3 available.

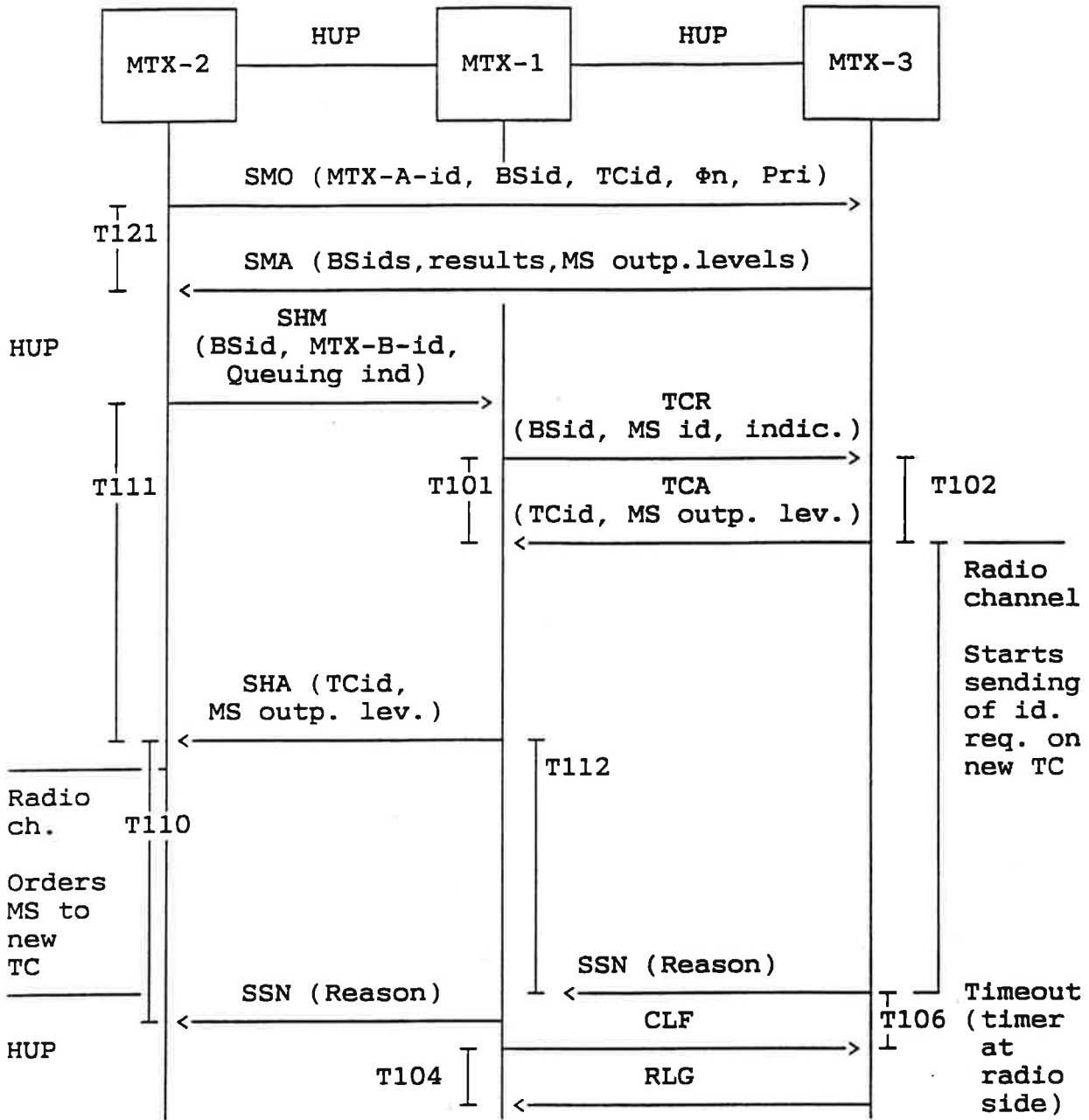

Figure 5.14 Subsequent Handover from MTX-2 to MTX-3; timer for sending identity request on new TC expires.

NT/HANDOVER USER PART ADDENDUM TO MOBILE USER PART SPECIFICATION FOR NMT-900	Date: 1992-12-21	Edition: 7	Page: 86
--	---------------------	---------------	-------------

### 5.3.3 Handover offer procedure from MTX-OF to MTX-A, MTX-B, ...

The use of this procedure is a national matter related to the use of the SLUX function.

The procedure starts when MTX-OF receives a Handover offer message (frame 42) from one of its base station.

If the call is not found within MTX-OF then MTX-OF shall send a Handover Offer Message (HOM) to all relevant MTXs connected to base stations which are neighbours to the offering base station.

When receiving the HOM from MTX-OF the MTX shall try to identify the call having the indicated traffic channel identity and supervisory signal number. Which base stations that are considered to be candidates for the serving base station are depending on the implementation in the MTX. Normally all base stations having the offering base station defined as neighbour are considered.

Depending on the identification of the call the MTX shall act in the following way:

- If the call is not identified the HOM shall be ignored.
- If exactly one call is identified the handover procedure is started according to the information parameter G (see below).
- If more than one call is identified with the indicated traffic channel identity and supervisory signal number the HOM message shall be ignored.
- If more than one call is identified with the indicated traffic channel identity and the supervisory signal number is not present in the HOM the handover procedure is started according to the information parameter G (see below) for all identified calls.

Depending on the information parameter G the MTX shall act in the following way:

- G(0) A normal handover procedure with signal strength measurements on all neighbouring base stations, both in serving MTX and in neighbouring MTXs as specified in paragraph 5.1, shall be initiated for the call(s) indicated by HOM.
- G(1) As for G(0) but a special reduced list of neighbouring base stations shall be used when the content of SMA is evaluated.

NT/HANDOVER USER PART ADDENDUM TO MOBILE USER PART SPECIFICATION FOR NMT-900	Date: 1992-12-21	Edition: 7	Page: 87
--	---------------------	---------------	-------------

- G(2) Signal strength measurements shall be performed only on the serving base station(s) and on the offering MTX as specified in paragraph 5.1. When receiving the response from the offering MTX in an SMA message only the measurement results from the offering base station are considered. After that a normal evaluation of measurement results from the serving and the offering base stations is performed. If the criteria for handover is fulfilled it shall be performed.
- G(4) Signal strength measurements shall be performed only on the offering MTX and only the results from the offering base station is considered in the response SMA from the offering MTX. If the offering base station fulfils the minimum rf level and has correct supervisory signal a handover is performed.
- G(8) No signal strength measurement must be ordered. Handover shall be initiated at once as specified in paragraphs 5.2 or 5.3.  
 This procedure shall not be used if the identification of the call is not unique. In this case the MTX shall use the procedure above (G(4)).

The value G(8) must only be used in the HOM if the identification of the call is unique and if so the HOM must only be sent to the serving MTX. If this demand is not fulfilled G(4) shall be used in stead.

The procedure is illustrated in figure 5.14.a.

NT/HANDOVER USER PART ADDENDUM TO MOBILE USER PART SPECIFICATION FOR NMT-900	Date: 1992-12-21	Edition: 7	Page: 88
--	---------------------	---------------	-------------

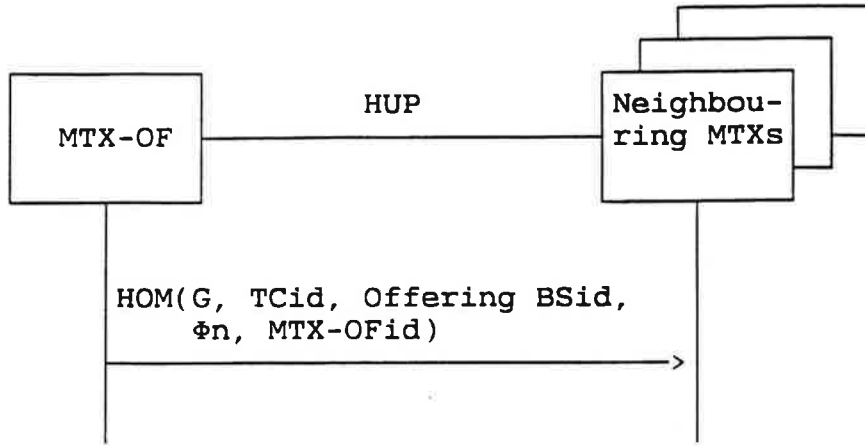

Figure 5.14.a Handover offer from MTX-OF to neighbouring MTXs.